

## 4 W HIGH POWER SP4T SWITCH

### DESCRIPTION

The  $\mu$ PG2183T6C is a GaAs MMIC SP4T (Single Pole Four Throw) switch which was designed for digital cellular phone application.

This device can operate frequency from 0.5 to 2.5 GHz, having the low insertion loss and high isolation.

This device is housed in a 16-pin plastic QFN (Quad Flat Non-leaded) (T6C) package. And this package is able to high-density surface mounting.

### FEATURES

- Supply voltage :  $V_{bat} = 2.9$  to  $3.2$  V (3.0 V TYP.)
- Standby mode voltage :  $V_{DD(H)} = 1.7$  to  $V_{bat}$  V (2.65 V TYP.)  
:  $V_{DD(L)} = 0$  to  $+0.05$  V (0 V TYP.)
- Switch control voltage :  $V_{cont(H)} = 1.7$  to  $V_{bat}$  V (2.65 V TYP.)  
:  $V_{cont(L)} = 0$  to  $+0.05$  V (0 V TYP.)
- Operating Frequency :  $f = 0.5$  to  $2.5$  GHz
- Low insertion loss :  $L_{ins1} = 0.4$  dB TYP. @  $f = 0.5$  to  $1.0$  GHz,  $V_{bat} = 3.0$  V,  $V_{DD} = V_{cont(H)} = 2.65$  V,  $V_{cont(L)} = 0$  V  
:  $L_{ins2} = 0.55$  dB TYP. @  $f = 1.0$  to  $2.0$  GHz,  $V_{bat} = 3.0$  V,  $V_{DD} = V_{cont(H)} = 2.65$  V,  $V_{cont(L)} = 0$  V  
:  $L_{ins3} = 0.7$  dB TYP. @  $f = 2.0$  to  $2.5$  GHz,  $V_{bat} = 3.0$  V,  $V_{DD} = V_{cont(H)} = 2.65$  V,  $V_{cont(L)} = 0$  V
- High isolation :  $ISL1 = 24$  dB TYP. @  $f = 0.5$  to  $1.0$  GHz,  $V_{bat} = 3.0$  V,  $V_{DD} = V_{cont(H)} = 2.65$  V,  $V_{cont(L)} = 0$  V  
:  $ISL2 = 19$  dB TYP. @  $f = 1.0$  to  $2.0$  GHz,  $V_{bat} = 3.0$  V,  $V_{DD} = V_{cont(H)} = 2.65$  V,  $V_{cont(L)} = 0$  V  
:  $ISL3 = 17$  dB TYP. @  $f = 2.0$  to  $2.5$  GHz,  $V_{bat} = 3.0$  V,  $V_{DD} = V_{cont(H)} = 2.65$  V,  $V_{cont(L)} = 0$  V
- Handling power :  $P_{in(0.1dB)} = +37.5$  dBm TYP. @  $f = 0.9$  GHz,  $V_{bat} = 3.0$  V,  $V_{DD} = V_{cont(H)} = 2.65$  V,  $V_{cont(L)} = 0$  V  
:  $P_{in(0.1dB)} = +35.0$  dBm TYP. @  $f = 1.8$  GHz,  $V_{bat} = 3.0$  V,  $V_{DD} = V_{cont(H)} = 2.65$  V,  $V_{cont(L)} = 0$  V
- High-density surface mounting : 16-pin plastic QFN (T6C) package ( $3.0 \times 3.0 \times 0.75$  mm)

### APPLICATIONS

- Digital cellular phone etc.

### ORDERING INFORMATION

Part Number	Order Number	Package	Marking	Supplying Form
$\mu$ PG2183T6C-E2	$\mu$ PG2183T6C-E2-A	16-pin plastic QFN (T6C) (Pb-Free)	2183	<ul style="list-style-type: none"> <li>• Embossed tape 12 mm wide</li> <li>• Pin 13, 14, 15 and 16 face the perforation side of the tape</li> <li>• Qty 3 kpcs/reel</li> </ul>

**Remark** To order evaluation samples, please contact your nearby sales office.

Part number for sample order:  $\mu$ PG2183T6C-A

**Caution** Although this device is designed to be as robust as possible, ESD (Electrostatic Discharge) can damage this device. This device must be protected at all times from ESD. Static charges may easily produce potentials of several kilovolts on the human body or equipment, which can discharge without detection. Industry-standard ESD precautions must be employed at all times.

The information in this document is subject to change without notice. Before using this document, please confirm that this is the latest version.

**PIN CONNECTIONS AND INTERNAL BLOCK DIAGRAM**

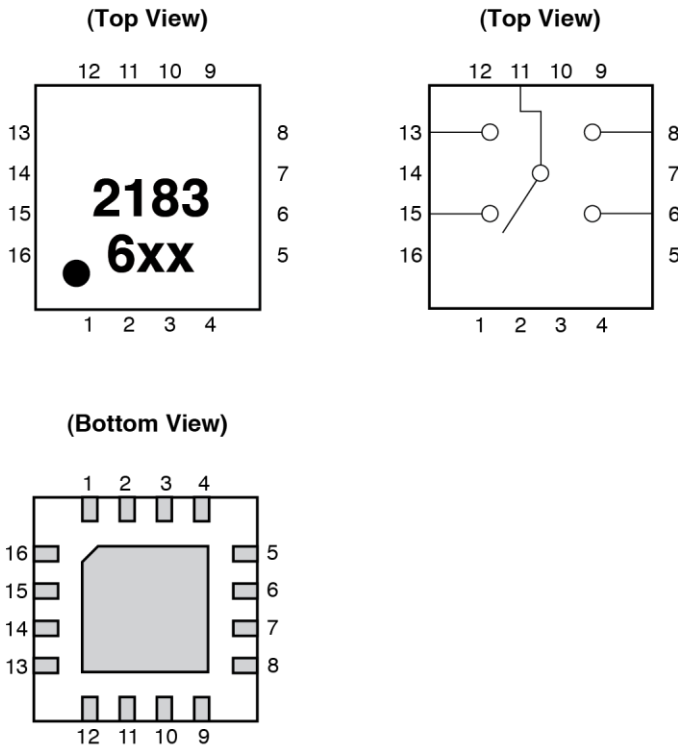

Pin No.	Pin Name
1	GND (N.C.)
2	V <sub>DD</sub>
3	V <sub>cont2</sub>
4	V <sub>cont1</sub>
5	GND
6	RF4
7	GND (N.C.)
8	RF3
9	GND (N.C.)
10	GND (N.C.)
11	ANT
12	GND (N.C.)
13	RF1
14	GND (N.C.)
15	RF2
16	V <sub>bat</sub>

**Remark** Exposed pad : GND

**SW TRUTH TABLE**

V <sub>bat</sub>	V <sub>DD</sub>	V <sub>cont1</sub>	V <sub>cont2</sub>	RF Path	Mode
High	High	Low	Low	ANT-RF1	Active mode
High	High	Low	High	ANT-RF2	Active mode
High	High	High	Low	ANT-RF3	Active mode
High	High	High	High	ANT-RF4	Active mode
High	Low	Low	Low	ANT-RF1	Standby mode
High	Low	Low	High	ANT-RF2	Standby mode
High	Low	High	Low	ANT-RF3	Standby mode
High	Low	High	High	ANT-RF4	Standby mode

**ABSOLUTE MAXIMUM RATINGS (T<sub>A</sub> = +25°C, unless otherwise specified)**

Parameter	Symbol	Ratings	Unit
Battery Voltage	V <sub>bat</sub>	+4.2	V
Standby Mode Voltage	V <sub>DD</sub>	+4.2	V
Switch Control Voltage	V <sub>cont</sub>	+4.2	V
Input Power	P <sub>in</sub>	+38	dBm
Operating Ambient Temperature	T <sub>A</sub>	-45 to +85	°C
Storage Temperature	T <sub>stg</sub>	-55 to +150	°C

**RECOMMENDED OPERATING RANGE (T<sub>A</sub> = +25°C, unless otherwise specified)**

Parameter	Symbol	MIN.	TYP.	MAX.	Unit
Battery Voltage	V <sub>bat</sub>	2.9	3.0	3.2	V
Standby Mode Voltage (H)	V <sub>DD (H)</sub>	1.7	2.65	V <sub>bat</sub>	V
Standby Mode Voltage (L)	V <sub>DD (L)</sub>	0	0	0.05	V
Switch Control Voltage (H)	V <sub>cont (H)</sub>	1.7	2.65	V <sub>bat</sub>	V
Switch Control Voltage (L)	V <sub>cont (L)</sub>	0	0	0.05	V

**ELECTRICAL CHARACTERISTICS**

( $T_A = +25^\circ\text{C}$ ,  $V_{\text{bat}} = 3.0\text{ V}$ ,  $V_{\text{DD}} = 2.65\text{ V}$ ,  $V_{\text{cont (H)}} = 2.65\text{ V}$ ,  $V_{\text{cont (L)}} = 0\text{ V}$ ,  $Z_o = 50\ \Omega$ , DC blocking capacitors = 56 pF, unless otherwise specified)

Parameter	Symbol	Test Conditions	MIN.	TYP.	MAX.	Unit
Insertion Loss 1	$L_{\text{ins1}}$	$f = 0.5\text{ to }1.0\text{ GHz}$	–	0.4	0.55	dB
Insertion Loss 2	$L_{\text{ins2}}$	$f = 1.0\text{ to }2.0\text{ GHz}$	–	0.55	0.8	dB
Insertion Loss 3	$L_{\text{ins3}}$	$f = 2.0\text{ to }2.5\text{ GHz}$	–	0.7	0.95	dB
Isolation 1	ISL1	$f = 0.5\text{ to }1.0\text{ GHz}$	22	24	–	dB
Isolation 2	ISL2	$f = 1.0\text{ to }2.0\text{ GHz}$	17	19	–	dB
Isolation 3	ISL3	$f = 2.0\text{ to }2.5\text{ GHz}$	15	17	–	dB
Input Return Loss	$RL_{\text{in}}$	$f = 0.5\text{ to }2.5\text{ GHz}$	15	19	–	dB
Output Return Loss	$RL_{\text{out}}$	$f = 0.5\text{ to }2.5\text{ GHz}$	15	19	–	dB
0.1 dB Loss Compression Input Power 1 <sup>Note</sup>	$P_{\text{in (0.1 dB) 1}}$	$f = 0.9\text{ GHz}$	+37.0	+37.5	–	dBm
0.1 dB Loss Compression Input Power 2 <sup>Note</sup>	$P_{\text{in (0.1 dB) 2}}$	$f = 1.8\text{ GHz}$	+34.0	+35.0	–	dBm
Harmonics 1	2f0	$f = 0.9\text{ GHz}$ , $P_{\text{in}} = 34.5\text{ dBm}$	–	–75	–65	dBc
	3f0		–	–75	–65	dBc
Harmonics 2	2f0	$f = 1.8\text{ GHz}$ , $P_{\text{in}} = 31.5\text{ dBm}$	–	–72	–62	dBc
	3f0		–	–75	–62	dBc
Battery Current 1	$I_{\text{bat1}}$	Active Mode, No RF	–	0.55	1.5	mA
Battery Current 2	$I_{\text{bat2}}$	Standby Mode, No RF	–	–	10	μA
Switched Supply Current 1	$I_{\text{DD1}}$	$V_{\text{DD}}$ : High, No RF	–	0	0.1	mA
Switched Supply Current 2	$I_{\text{DD2}}$	$V_{\text{DD}}$ :Low, No RF	–	0	0.1	mA
Control Current 1-1	$I_{\text{cont 1-1}}$	$V_{\text{cont1}}$ : High, No RF	–100	0	100	μA
Control Current 1-2	$I_{\text{cont 1-2}}$	$V_{\text{cont1}}$ : Low, No RF	–100	0	100	μA
Control Current 2-1	$I_{\text{cont 2-1}}$	$V_{\text{cont2}}$ : High, No RF	–100	0	100	μA
Control Current 2-2	$I_{\text{cont 2-2}}$	$V_{\text{cont2}}$ : Low, No RF	–100	0	100	μA
Switch Control Speed	$t_{\text{sw}}$	50% CTL to 90/10%	–	0.5	5.0	μs
Startup Time	–	Time for the switch to be operational from that the switched supply voltage ( $V_{\text{DD}}$ ) goes high.	–	–	100	μs

**Note**  $P_{\text{in (0.1 dB)}}$  is measured the input power level when the insertion loss increases more 0.1 dB than that of linear range.

**Caution** This device is used it is necessary to use DC blocking capacitors.

The value of DC blocking capacitors should be chosen to accommodate the frequency of operation, bandwidth, switching speed and the condition with actual board of your system. The range of recommended DC blocking capacitor value is less than 56 pF.

EVALUATION CIRCUIT

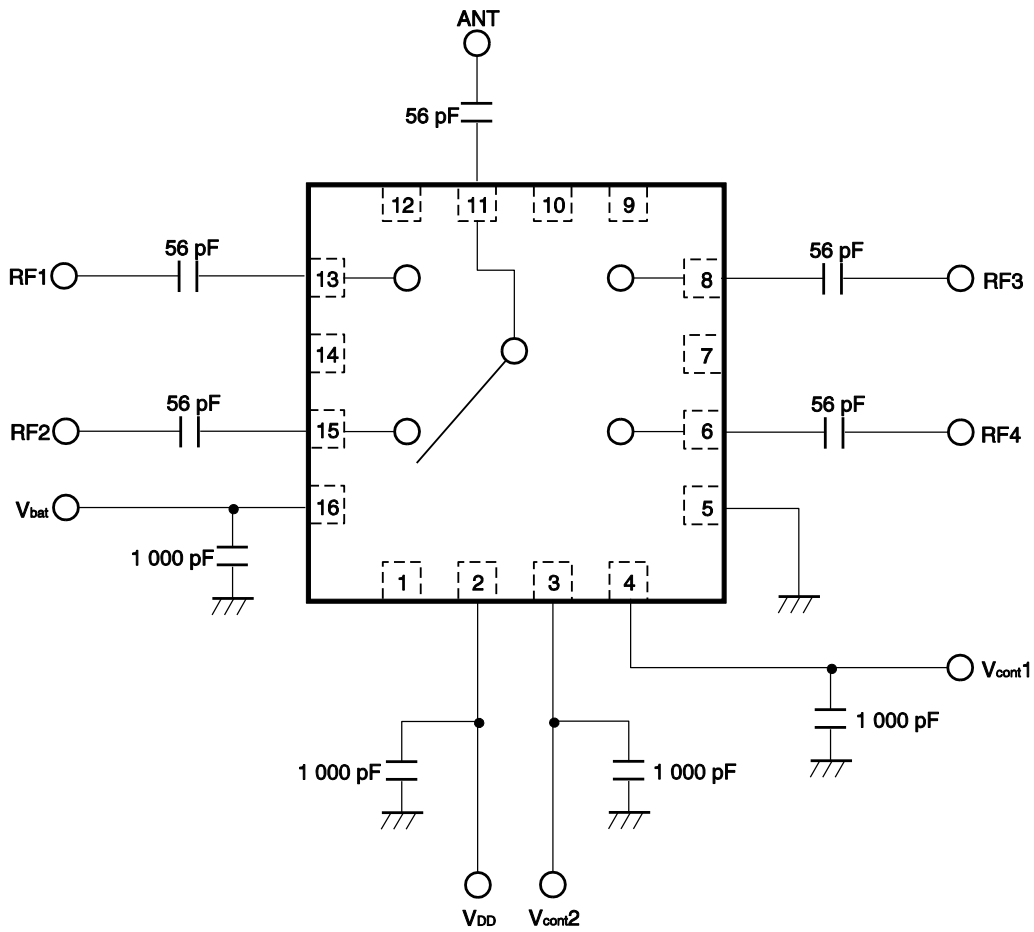

The application circuits and their parameters are for reference only and are not intended for use in actual design-ins.

APPLICATION INFORMATION

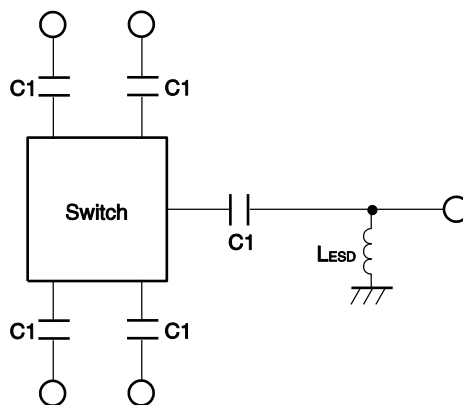

- L<sub>ESD</sub> provides a means to increase the ESD protection on a specific RF port, typically the port attached to the antenna.
- The value may be tailored to provide specific electrical responses.
- The RF ground connections should be kept as short as possible and connected to directly to a good RF ground for best performance.

**PERFORMANCE DATA**

( $T_A = +25^\circ\text{C}$ ,  $V_{\text{bat}} = 3.0\text{ V}$ ,  $V_{\text{DD}} = 2.65\text{ V}$ ,  $V_{\text{cont (H)}} = 2.65\text{ V}$ ,  $V_{\text{cont (L)}} = 0\text{ V}$ , DC blocking capacitors = 56 pF, unless otherwise specified)

**INSERTION LOSS vs. FREQUENCY**

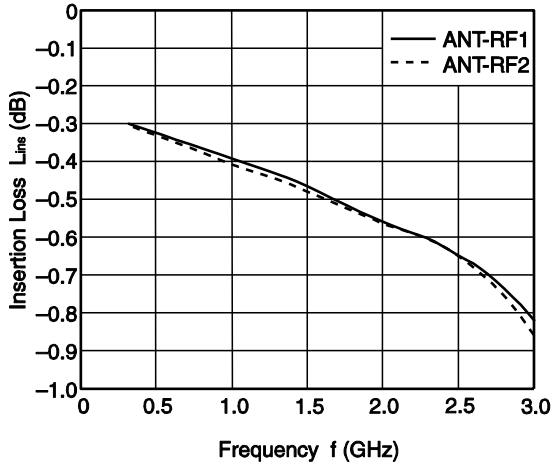

**ISOLATION vs. FREQUENCY**

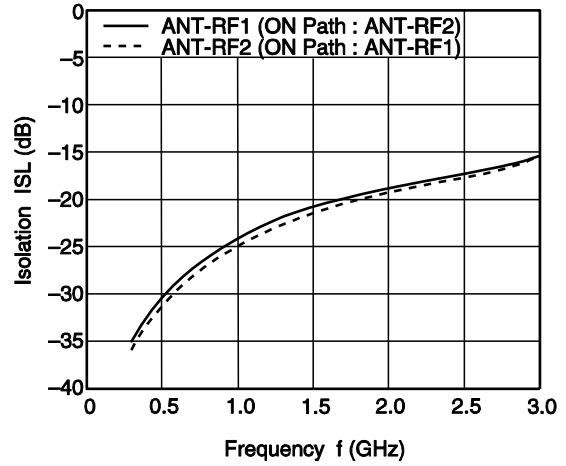

**INPUT RETURN LOSS vs. FREQUENCY**

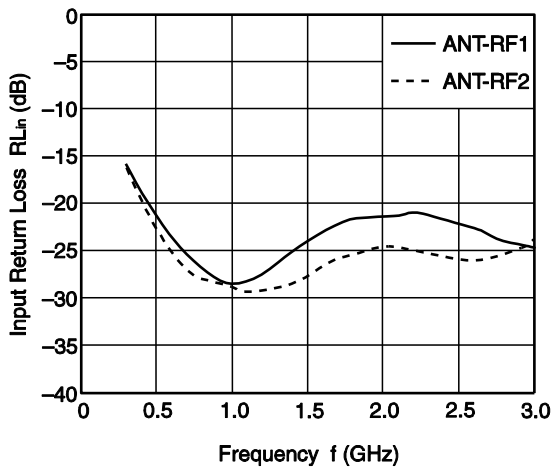

**OUTPUT RETURN LOSS vs. FREQUENCY**

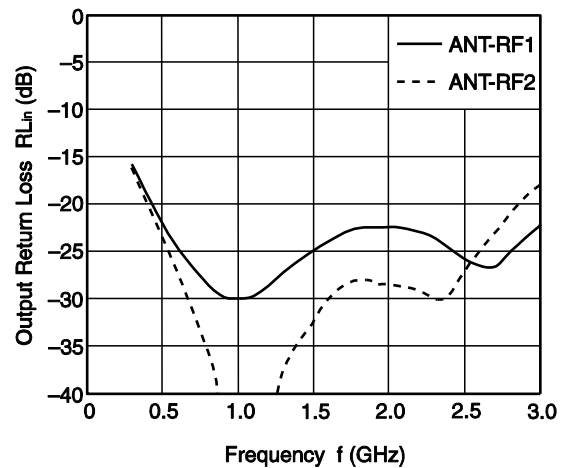

**Remark** The graphs indicate nominal characteristics.

INSERTION LOSS, BATTERY CURRENT vs. INPUT POWER

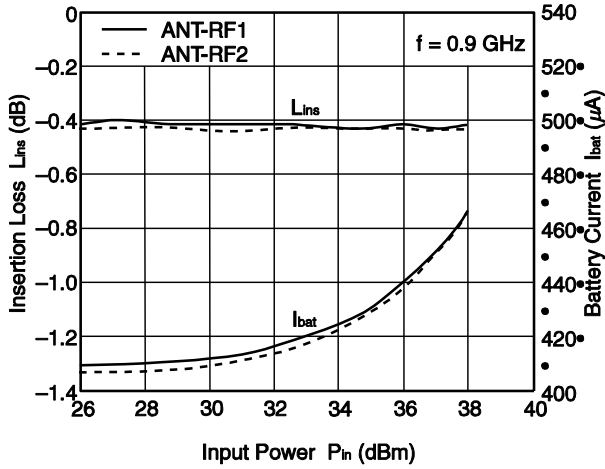

2ND HARMONICS, 3RD HARMONICS vs. INPUT POWER

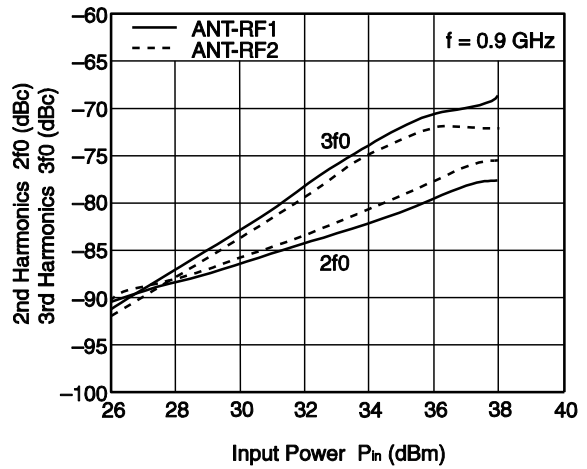

INSERTION LOSS, BATTERY CURRENT vs. INPUT POWER

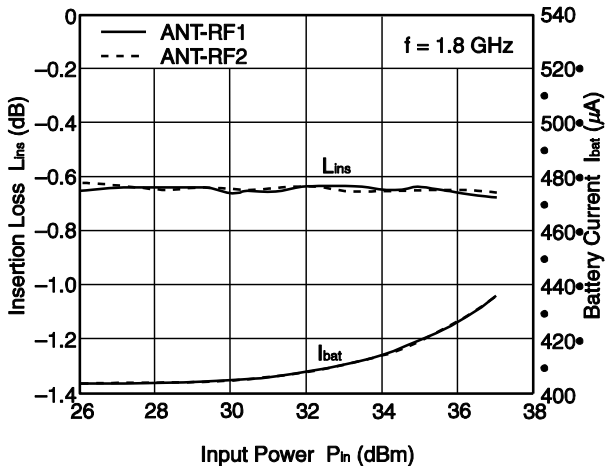

2ND HARMONICS, 3RD HARMONICS vs. INPUT POWER

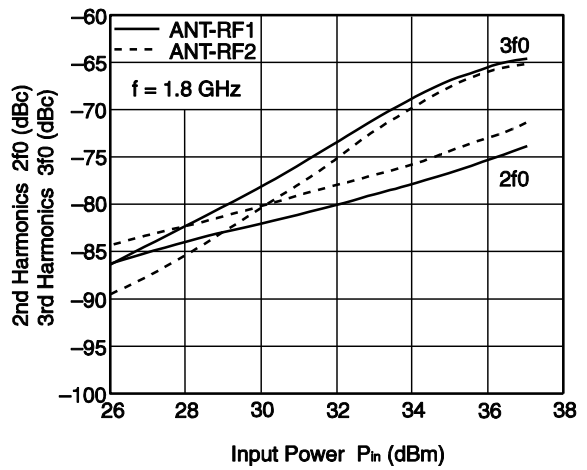

Remark The graphs indicate nominal characteristics.

REFERENCE DATA ( $T_A = +25^\circ\text{C}$ ,  $V_{DD} = 1.8\text{ V}$ ,  $V_{\text{cont}}(\text{H}) = 1.8\text{ V}$ ,  $V_{\text{cont}}(\text{L}) = 0\text{ V}$ , DC blocking capacitors = 56 pF, unless otherwise specified)

INSERTION LOSS vs. BATTERY VOLTAGE

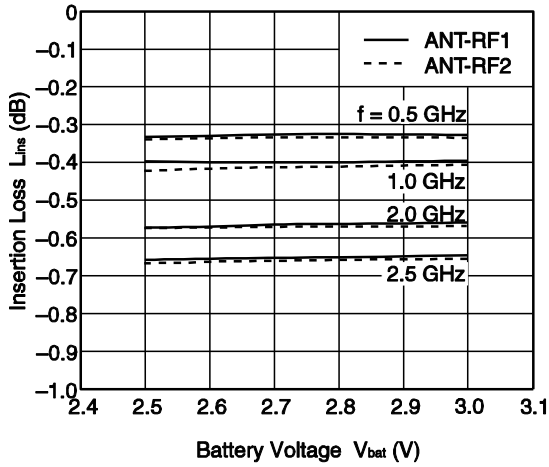

ISOLATION vs. BATTERY VOLTAGE

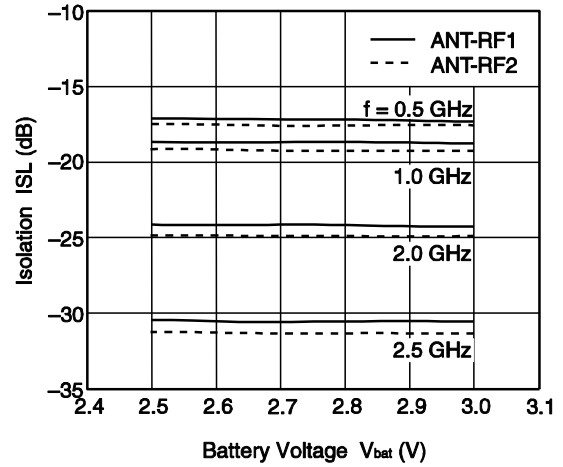

INSERTION LOSS vs. INPUT POWER

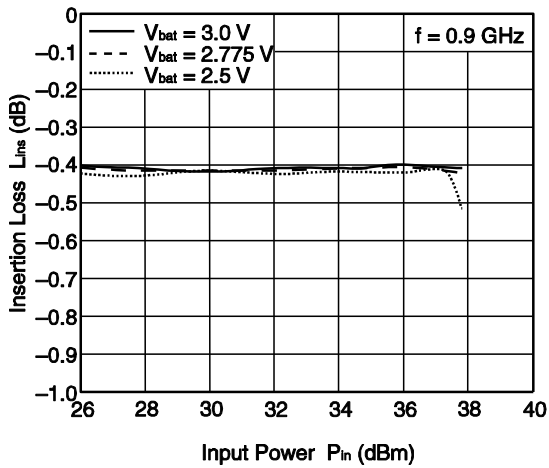

2ND HARMONICS vs. INPUT POWER

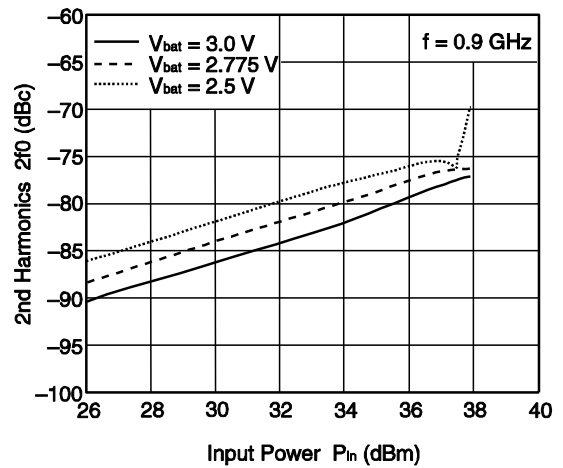

3RD HARMONICS vs. INPUT POWER

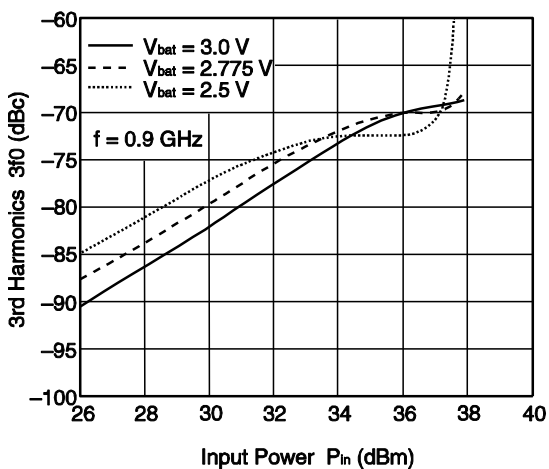

Remark The graphs indicate nominal characteristics.



INSERTION LOSS vs. INPUT POWER

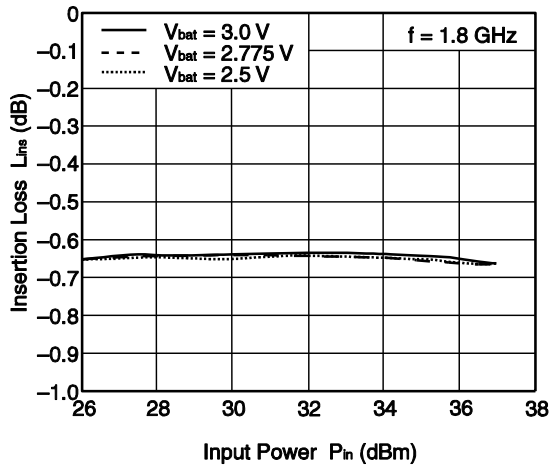

2ND HARMONICS vs. INPUT POWER

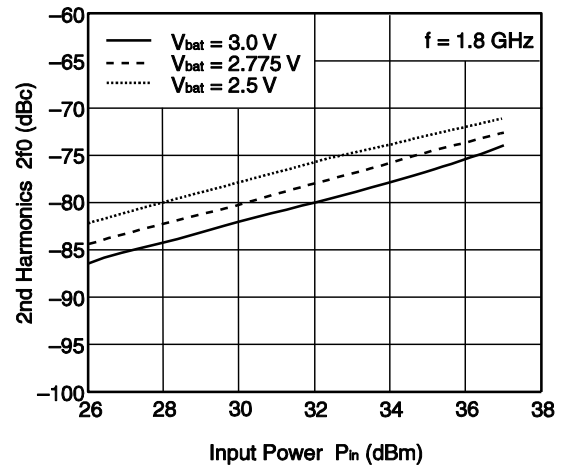

3RD HARMONICS vs. INPUT POWER

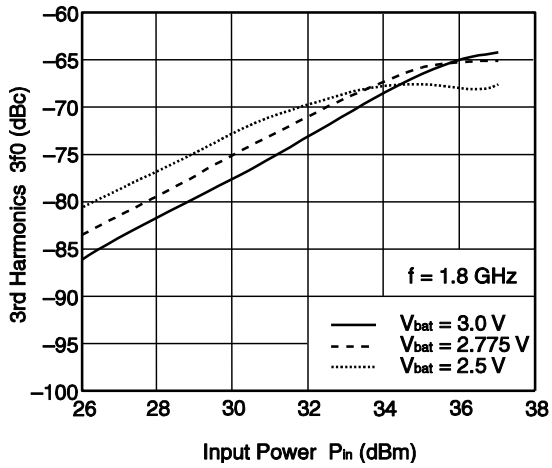

Remark The graphs indicate nominal characteristics.

**MOUNTING PAD LAYOUT DIMENSIONS**

**16-PIN PLASTIC QFN (T6C) (UNIT: mm)**

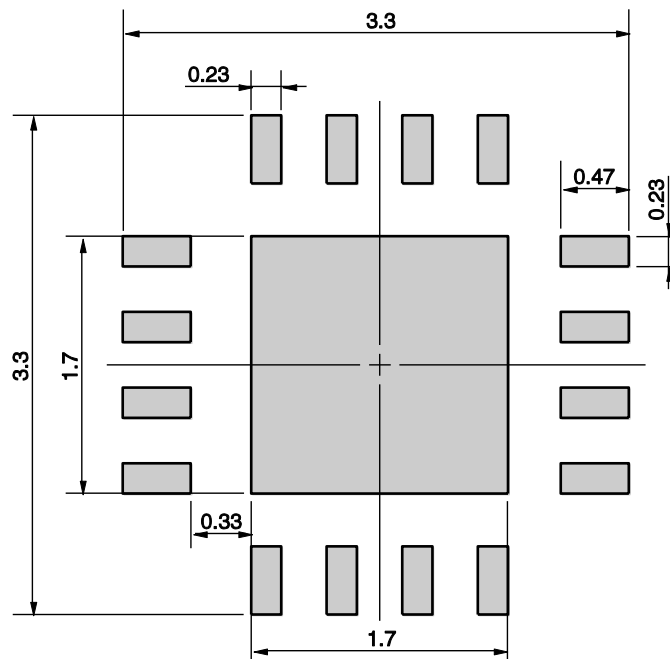

**Remark** The mounting pad layout in this document is for reference only.  
 When designing PCB, please consider workability of mounting, solder joint reliability, prevention of solder bridge and so on, in order to optimize the design.

PACKAGE DIMENSIONS

16-PIN PLASTIC QFN (T6C) (UNIT: mm)

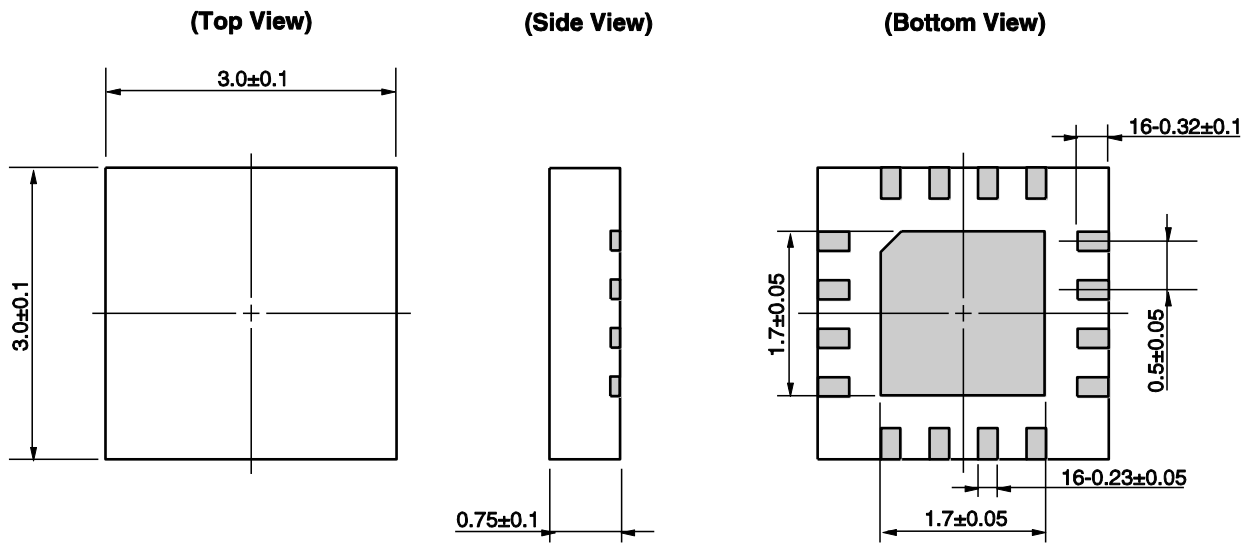

**RECOMMENDED SOLDERING CONDITIONS**

This product should be soldered and mounted under the following recommended conditions. For soldering methods and conditions other than those recommended below, contact your nearby sales office.

Soldering Method	Soldering Conditions	Condition Symbol
Infrared Reflow	Peak temperature (package surface temperature) : 260°C or below Time at peak temperature : 10 seconds or less Time at temperature of 220°C or higher : 60 seconds or less Preheating time at 120 to 180°C : 120±30 seconds Maximum number of reflow processes : 3 times Maximum chlorine content of rosin flux (% mass) : 0.2%(Wt.) or below	IR260
Partial Heating	Peak temperature (pin temperature) : 350°C or below Soldering time (per side of device) : 3 seconds or less Maximum chlorine content of rosin flux (% mass) : 0.2%(Wt.) or below	HS350

**Caution Do not use different soldering methods together (except for partial heating).**

<p><b>Caution</b> GaAs Products</p>	<p>This product uses gallium arsenide (GaAs). GaAs vapor and powder are hazardous to human health if inhaled or ingested, so please observe the following points.</p> <ul style="list-style-type: none"> <li>• Follow related laws and ordinances when disposing of the product. If there are no applicable laws and/or ordinances, dispose of the product as recommended below.               <ol style="list-style-type: none"> <li>1. Commission a disposal company able to (with a license to) collect, transport and dispose of materials that contain arsenic and other such industrial waste materials.</li> <li>2. Exclude the product from general industrial waste and household garbage, and ensure that the product is controlled (as industrial waste subject to special control) up until final disposal.</li> </ol> </li> <li>• Do not burn, destroy, cut, crush, or chemically dissolve the product.</li> <li>• Do not lick the product or in any way allow it to enter the mouth.</li> </ul>
-------------------------------------	---

# Mouser Electronics

Authorized Distributor

Click to View Pricing, Inventory, Delivery & Lifecycle Information:

[CEL:](#)

[UPG2155TB-A](#) [UPG2155TB-E4-A](#)