

9-36V ProLynx™ 5A: Non-Isolated DC-DC Power Modules

9Vdc –36Vdc input; 3Vdc to 18Vdc output; 5A to 2.5A Scaled output current

9Vdc –24Vdc input; -3.3Vdc to -18Vdc output¹; 5A to 0.7A Scaled output current

TUNABLE LOOP™
A LINEAGE POWER TRADEMARK



RoHS Compliant

Applications

- Industrial equipment
- Distributed power architectures
- Intermediate bus voltage applications
- Telecommunications equipment

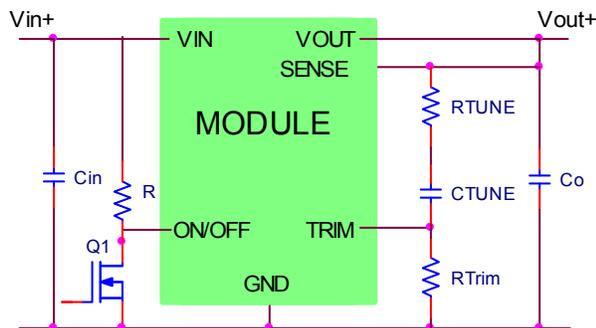

Description

The 9-36V ProLynx™ series of power modules are non-isolated dc-dc converters that can deliver up to 5A of output current. These modules operate over an extra wide range of input voltage ($V_{IN} = 9Vdc - 36Vdc$) and provide a precisely regulated output voltage from 3Vdc to 18Vdc, programmable via an external resistor. Two new features added with this family of products are the ability to externally tune the voltage control loop and a variable current limit inversely dependent on output voltage. Other features include remote On/Off, adjustable output voltage, over current and over temperature protection. The Ruggedized version (-D) is capable of operation up to 105°C and withstand high levels of shock and vibration. The Tunable Loop™, allows the user to optimize the dynamic response of the converter to match the load with reduced amount of output capacitance leading to savings on cost and PWB area and AutoLimit enables the module to deliver the max possible output power across the entire voltage range. The 9-36V ProLynx can also be used for negative output voltage loads through the use of a specific application schematic

Features

- Compliant to RoHS EU Directive 2002/95/EC (Z versions)
- Compatible in a Pb-free or SnPb reflow environment (Z versions)
- Compliant to IPC-9592 (September 2008), Category 2, Class II
- Extra Wide Input voltage range (9Vdc–36Vdc)
- Output voltage programmable from 3Vdc to 18 Vdc via external resistor
- Tunable Loop™ to optimize dynamic output voltage response
- Patent Pending AutoLimit automatic scaling of current limit with output voltage
- Output overcurrent protection (non-latching)
- Overtemperature protection
- Remote On/Off
- Remote Sense
- Small size: 20.3 mm x 11.4 mm x 8.5 mm (0.8 in x 0.45 in x 0.335 in)
- Wide operating temperature range [-40°C to 105°C(Ruggedized: -D), 85°C(Regular)]
- UL* 60950-1, 2nd Ed. Recognized, CSA† C22.2 No. 60950-1-07 Certified, and VDE‡ (EN60950-1, 2nd Ed.) Licensed
- ISO** 9001 and ISO 14001 certified manufacturing facilities

* UL is a registered trademark of Underwriters Laboratories, Inc.

† CSA is a registered trademark of Canadian Standards Association.

‡ VDE is a trademark of Verband Deutscher Elektrotechniker e.V.

** ISO is a registered trademark of the International Organization of Standards

¹ Output range linked to input voltage range see page 24

9-36V ProLynx™ 5A: Non-Isolated DC-DC Power Modules

9Vdc –36Vdc input; 3Vdc to 18Vdc output; 5A to 2.5A Scaled output current

9Vdc –24Vdc input; -3.3Vdc to -18Vdc output; 5A to 0.7A Scaled output current

Absolute Maximum Ratings

Stresses in excess of the absolute maximum ratings can cause permanent damage to the device. These are absolute stress ratings only, functional operation of the device is not implied at these or any other conditions in excess of those given in the operations sections of the data sheet. Exposure to absolute maximum ratings for extended periods can adversely affect the device reliability.

Parameter	Device	Symbol	Min	Max	Unit
Input Voltage Continuous	All	V_{IN}	-0.3	37	V
Operating Ambient Temperature (see Thermal Considerations section)	All -D version	T_A T_A	-40 -40	85 105	°C °C
Storage Temperature	All	T_{stg}	-55	125	°C

Electrical Specifications

Unless otherwise indicated, specifications apply over all operating input voltage, resistive load, and temperature conditions.

Parameter	Device	Symbol	Min	Typ	Max	Unit
Operating Input Voltage	All	V_{IN}	9	—	36	Vdc
Maximum Input Current ($V_{IN}=9V$ to 36V, $I_o=I_{o,max}$)	All	$I_{IN,max}$			5	Adc
Input No Load Current ($V_{IN} = 28V$, $I_o = 0$, module enabled)	$V_{O,set} = 3Vdc$	$I_{IN,No\ load}$		26		mA
($V_{IN} = 28V$, $I_o = 0$, module enabled)	$V_{O,set} = 18Vdc$	$I_{IN,No\ load}$		50		mA
Input Stand-by Current ($V_{IN} = 28Vdc$, module disabled)	All	$I_{IN,stand-by}$		3		mA
Inrush Transient	All	I^2t			0.5	A ² s
Input Reflected Ripple Current, peak-to-peak (5Hz to 20MHz, 1 μ H source impedance; $V_{IN} = 0$ to 36V, $I_o = I_{o,max}$; See Test Configurations)	All				95	mAp-p
Input Ripple Rejection (120Hz)	All		-24	-45	-60	dB

CAUTION: This power module is not internally fused. An input line fuse must always be used.

This power module can be used in a wide variety of applications, ranging from simple standalone operation to an integrated part of sophisticated power architecture. To preserve maximum flexibility, internal fusing is not included; however, to achieve maximum safety and system protection, always use an input line fuse. The safety agencies require a fast-acting fuse with a maximum rating of 8 A (see Safety Considerations section). Based on the information provided in this data sheet on inrush energy and maximum dc input current, the same type of fuse with a lower rating can be used. Refer to the fuse manufacturer's data sheet for further information.

9-36V ProLynx™ 5A: Non-Isolated DC-DC Power Modules

9Vdc –36Vdc input; 3Vdc to 18Vdc output; 5A to 2.5A Scaled output current

9Vdc –24Vdc input; -3.3Vdc to -18Vdc output; 5A to 0.7A Scaled output current

Electrical Specifications (continued)

Parameter	Device	Symbol	Min	Typ	Max	Unit
Output Voltage Set-point	All	$V_{O, set}$	-2.0		+2.0	% $V_{O, set}$
Output Voltage (Over all operating input voltage, resistive load, and temperature conditions until end of life)	All	$V_{O, set}$	-2.5	—	+2.5	% $V_{O, set}$
Adjustment Range (elected by an external resistor) (Some output voltages may not be possible depending on the input voltage – see Feature Descriptions Section)	All	V_o	3		18	Vdc
Output Regulation						
Line ($V_{IN}=V_{IN, min}$ to $V_{IN, max}$)	All			—	0.4	% $V_{O, set}$
Load ($I_o=I_{o, min}$ to $I_{o, max}$)	All			—	0.4	% $V_{O, set}$
Temperature ($T_{ref}=T_{A, min}$ to $T_{A, max}$)	All			—	0.4	% $V_{O, set}$
Remote Sense Range	All				0.5	Vdc
Output Ripple and Noise on nominal output ($V_{IN}=V_{IN, nom}$ and $I_o=I_{o, min}$ to $I_{o, max}$ $C_O = 0.1\mu F // 10\mu F$ ceramic capacitors)						
$V_{out}=3.3V$, $V_{in}=28V$						
Peak-to-Peak (5Hz to 20MHz bandwidth)	All			45		mV _{pk-pk}
RMS (5Hz to 20MHz bandwidth)	All			14		mV _{rms}
$V_{out}=18V$, $V_{in}=28V$						
Peak-to-Peak (5Hz to 20MHz bandwidth)	All			143		mV _{pk-pk}
RMS (5Hz to 20MHz bandwidth)	All			47		mV _{rms}
External Capacitance ¹						
Without the Tunable Loop™						
ESR $\geq 1\text{ m}\Omega$	All	$C_{O, max}$	0	—	47	μF
ESR $\geq 10\text{ m}\Omega$	All	$C_{O, max}$	0	—	100	μF
With the Tunable Loop™						
ESR $\geq 0.15\text{ m}\Omega$	All	$C_{O, max}$	0	—	100	μF
ESR $\geq 10\text{ m}\Omega$	All	$C_{O, max}$	0	—	2000*	μF
Output Current ($V_o=3V$)	All	I_o	0		5	Adc
$V_o=5V$	All	I_o	0		4.7	Adc
$V_o=12V$	All	I_o	0		3.5	Adc
$V_o=18V$	All	I_o	0		2.5	Adc
Output Current Limit Inception (Hiccup Mode)	All	$I_{o, lim}$		160		% $I_{o, max}$
Output Short-Circuit Current 12Vin 25C ($V_o \leq 250\text{mV}$) (Hiccup Mode) 28Vin	All	$I_{o, s/c}$		2		Adc
Efficiency ($I_o=I_{o, max}$, $V_o=V_{O, set}$)						
$V_{IN}=12\text{Vdc}$, $T_A=25^\circ\text{C}$	$V_{O, set}=3.3\text{Vdc}$	η		91.0		%
$V_{IN}=12\text{Vdc}$, $T_A=25^\circ\text{C}$	$V_{O, set}=5\text{Vdc}$	η		93.3		%
$V_{IN}=28\text{Vdc}$, $T_A=25^\circ\text{C}$	$V_{O, set}=12\text{Vdc}$	η		94.7		%
$V_{IN}=28\text{Vdc}$, $T_A=25^\circ\text{C}$	$V_{O, set}=18\text{Vdc}$	η		95.9		%
Switching Frequency	All	f_{sw}	—	300	—	kHz

¹Depending on Input and Output Voltage, external capacitors require using the new Tunable Loop™ feature to ensure that the module is stable as well as getting the best transient response. See the Tunable Loop™ section for details.

* Larger values may be possible at specific output voltages. Please consult your GE Technical representative for additional details.

9-36V ProLynx™ 5A: Non-Isolated DC-DC Power Modules

9Vdc –36Vdc input; 3Vdc to 18Vdc output; 5A to 2.5A Scaled output current

9Vdc –24Vdc input; -3.3Vdc to -18Vdc output; 5A to 0.7A Scaled output current

Electrical Specifications (continued)

Parameter	Device	Symbol	Min	Typ	Max	Unit
Switching Frequency	All	f_{sw}	—	300	—	kHz

General Specifications

Parameter	Min	Typ	Max	Unit
Calculated MTBF ($I_o=0.8I_{o,max}$, $T_A=40^\circ\text{C}$) Telcordia Issue 2, Method 1, Case 3		17,822,788		Hours
Weight	—	3.49 (0.123)	—	g (oz.)

9-36V ProLynx™ 5A: Non-Isolated DC-DC Power Modules

9Vdc –36Vdc input; 3Vdc to 18Vdc output; 5A to 2.5A Scaled output current

9Vdc –24Vdc input; -3.3Vdc to -18Vdc output; 5A to 0.7A Scaled output current

Feature Specifications

Unless otherwise indicated, specifications apply over all operating input voltage, resistive load, and temperature conditions. See Feature Descriptions for additional information.

Parameter	Device	Symbol	Min	Typ	Max	Unit
On/Off Signal Interface ($V_{IN}=V_{IN, min}$ to $V_{IN, max}$; open collector or equivalent, Signal referenced to GND) Device is with suffix "4" – Positive Logic (See Ordering Information)						
Logic High (Module ON)						
Input High Current	All	I_{IH}		—	160	μA
Input High Voltage	All	V_{IH}	4.2	—	12	V
Logic Low (Module OFF)						
Input Low Current	All	I_{IL}	—	—	0.5	mA
Input Low Voltage	All	V_{IL}	-0.3	—	3.3	V
Device Code with no suffix – Negative Logic (See Ordering Information)						
Logic High (Module OFF)						
Input High Current	All	I_{IH}	—	—	3	mA
Input High Voltage	All	V_{IH}	1.5	—	36	Vdc
Logic Low (Module ON)						
Input low Current	All	I_{IL}	—	—	220	μA
Input Low Voltage	All	V_{IL}	-0.2	—	1	Vdc
Turn-On Delay and Rise Times						
($V_{IN}=V_{IN, nom}$, $I_O=I_{O, max}$, V_O to within $\pm 1\%$ of steady state) Case 1: On/Off input is enabled and then input power is applied (delay from instant at which $V_{IN} = V_{IN, min}$ until $V_O =$ 10% of $V_{O, set}$)	All	T_{delay}	—	9	—	msec
Case 2: Input power is applied for at least one second and then the On/Off input is enabled (delay from instant at which Von/Off is enabled until $V_O = 10\%$ of $V_{O, set}$)	All	T_{delay}	—	7	—	msec
Output voltage Rise time (time for V_O to rise from 10% of $V_{O, set}$ to 90% of $V_{O, set}$)	All	T_{rise}	—	8	—	msec
Output voltage overshoot ($T_A = 25^\circ C$ $V_{IN}=V_{IN, min}$ to $V_{IN, max}$, $I_O=I_{O, min}$ to $I_{O, max}$) With or without maximum external capacitance					3	% $V_{O, set}$
Over Temperature Protection (See Thermal Considerations section)	All	T_{ref}		130		$^\circ C$
Input Undervoltage Lockout						
Turn-on Threshold	All				7.5	Vdc
Turn-off Threshold	All				7.35	Vdc
Hysteresis	All			0.15		Vdc

9-36V ProLynx™ 5A: Non-Isolated DC-DC Power Modules

9Vdc –36Vdc input; 3Vdc to 18Vdc output; 5A to 2.5A Scaled output current

9Vdc –24Vdc input; -3.3Vdc to -18Vdc output; 5A to 0.7A Scaled output current

Characteristic Curves

The following figures provide typical characteristics for the 9-36V ProLynx™ 5A at 3.3Vo and at 25°C.

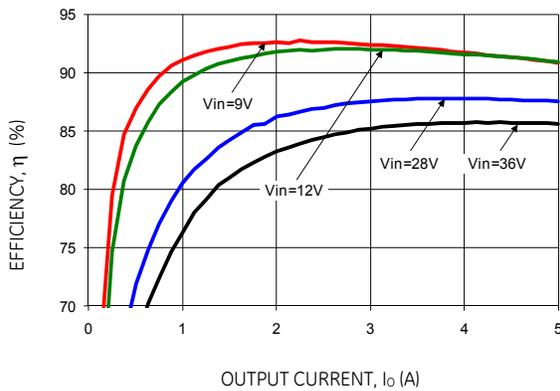

Figure 1. Converter Efficiency versus Output Current.

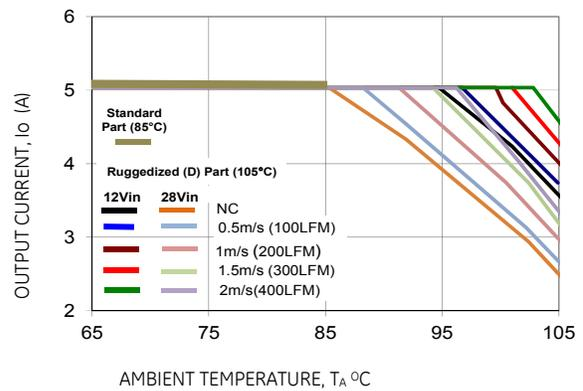

Figure 2. Derating Output Current versus Ambient Temperature and Airflow.

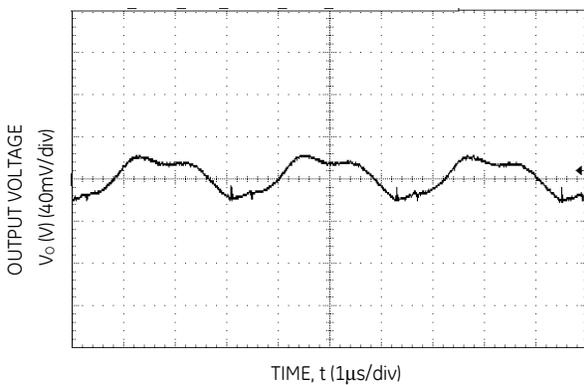

Figure 3. Typical output ripple and noise ($V_{IN} = 28V$, $I_o = I_{o,max}$).

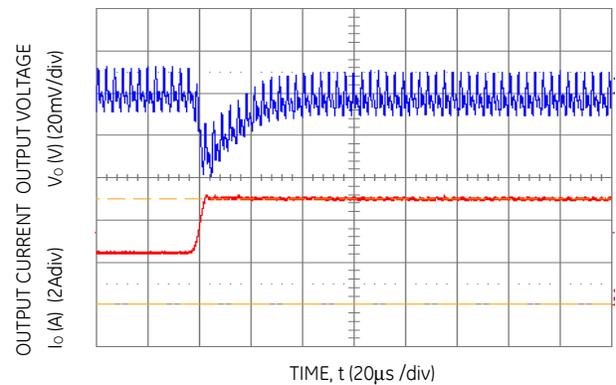

Figure 4. Transient Response to Dynamic Load Change from 50% to 100% at 28Vin, $C_{ext} = 10\mu F$ ceramic + 330µF polymer, $C_{Tune}=10nF$ & $R_{Tune}=150\Omega$

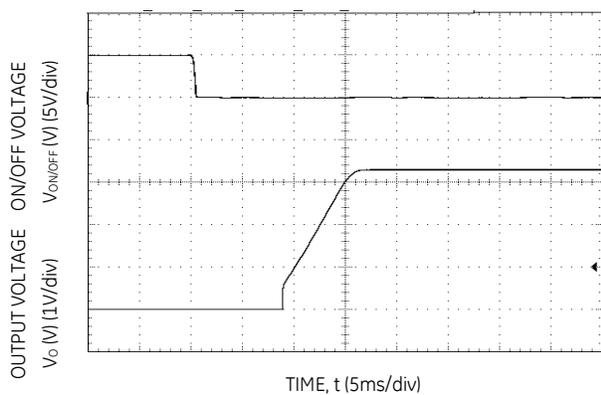

Figure 5. Typical Start-up Using On/Off Voltage ($I_o = I_{o,max}$).

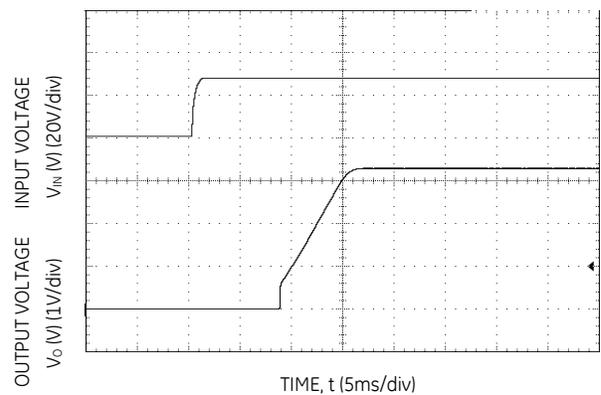

Figure 6. Typical Start-up Using Input Voltage ($V_{IN} = 28V$, $I_o = I_{o,max}$).

9-36V ProLynx™ 5A: Non-Isolated DC-DC Power Modules

9Vdc –36Vdc input; 3Vdc to 18Vdc output; 5A to 2.5A Scaled output current

9Vdc –24Vdc input; -3.3Vdc to -18Vdc output; 5A to 0.7A Scaled output current

Characteristic Curves

The following figures provide typical characteristics for the 9-36V ProLynx™ 5A at 5Vo and at 25°C. (4.5A rated output)

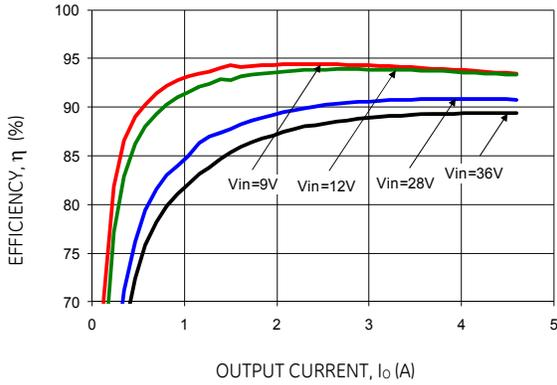

Figure 7. Converter Efficiency versus Output Current.

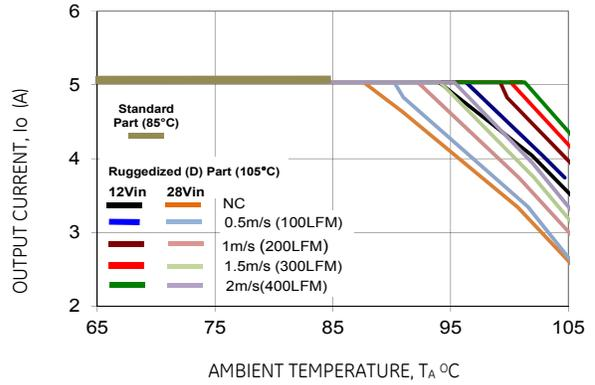

Figure 8. Derating Output Current versus Ambient Temperature and Airflow.

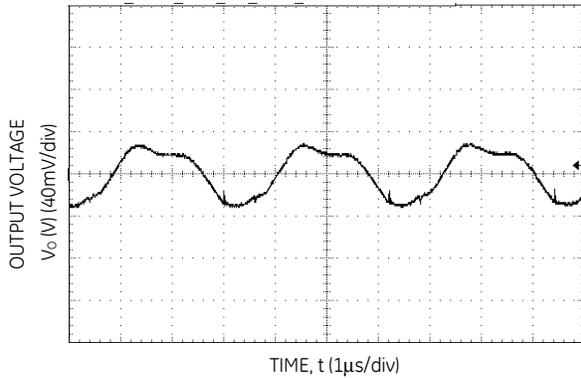

Figure 9. Typical output ripple and noise ($V_{IN} = 28V$, $I_o = I_{o,max}$).

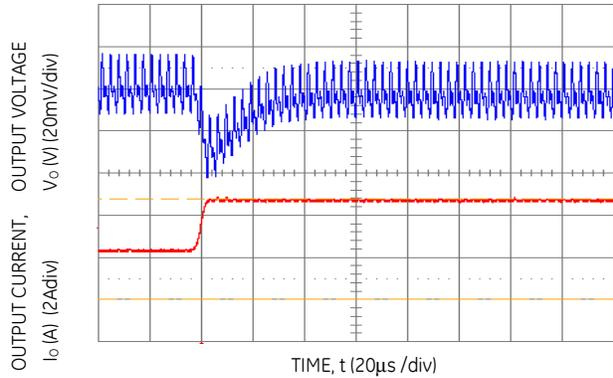

Figure 10. Transient Response to Dynamic Load Change from 50% to 100% at 28Vin, $C_{ext} = 10\mu F$ ceramic + 330 μF polymer, $C_{Tune}=10nF$ & $R_{Tune}=150\Omega$

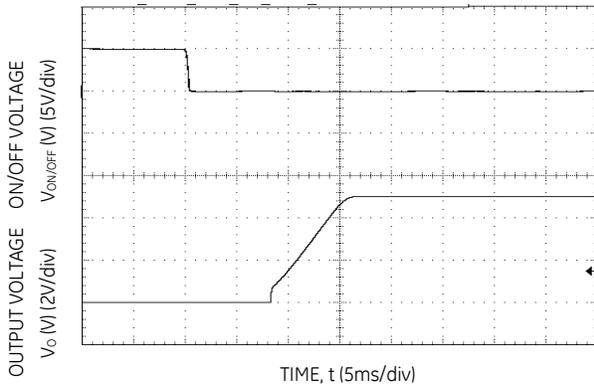

Figure 11. Typical Start-up Using On/Off Voltage ($I_o = I_{o,max}$).

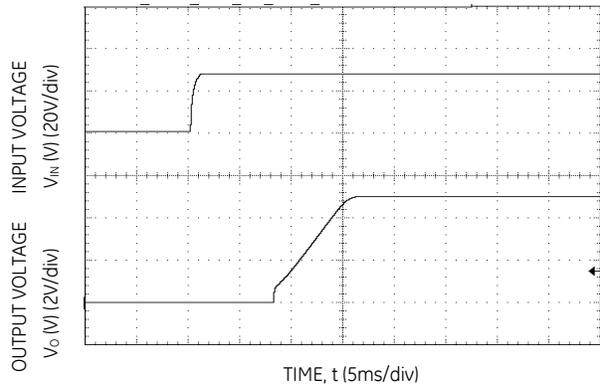

Figure 12. Typical Start-up Using Input Voltage ($V_{IN} = 28V$, $I_o = I_{o,max}$).

9-36V ProLynx™ 5A: Non-Isolated DC-DC Power Modules

9Vdc –36Vdc input; 3Vdc to 18Vdc output; 5A to 2.5A Scaled output current

9Vdc –24Vdc input; -3.3Vdc to -18Vdc output; 5A to 0.7A Scaled output current

Characteristic Curves

The following figures provide typical characteristics for the 9-36V ProLynx™ 5A at 12Vo and at 25°C. (3.5A rated output)

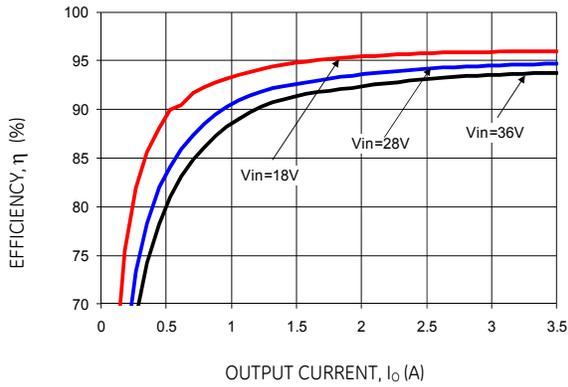

Figure 13. Converter Efficiency versus Output Current.

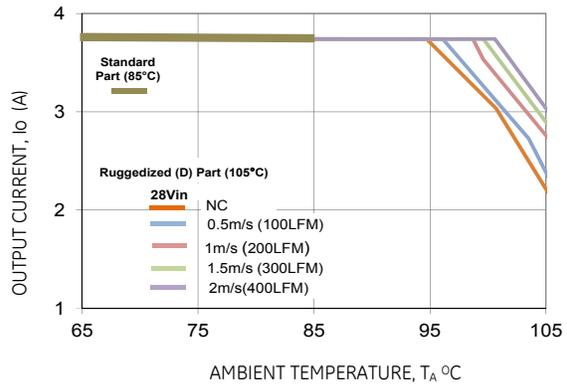

Figure 14. Derating Output Current versus Ambient Temperature and Airflow.

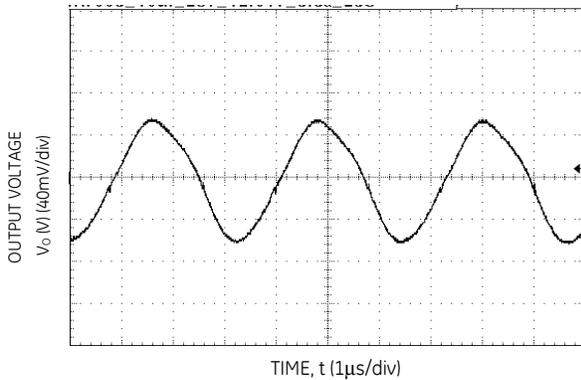

Figure 15. Typical output ripple and noise ($V_{IN} = 28V$, $I_o = I_{o,max}$).

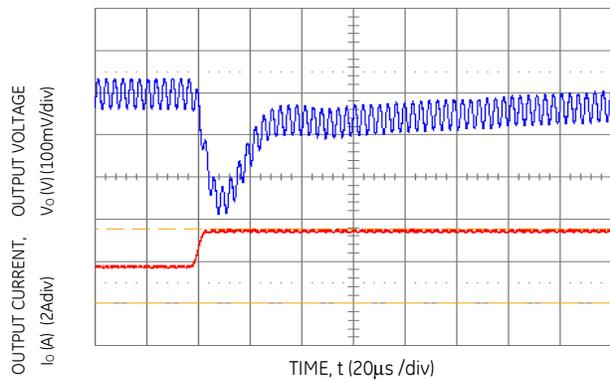

Figure 16. Transient Response to Dynamic Load Change from 50% to 100% at 28Vin, $C_{ext} = 3 \times 10\mu F$ ceramic, $C_{Tune} = 470pF$ & $R_{Tune} = 150\Omega$

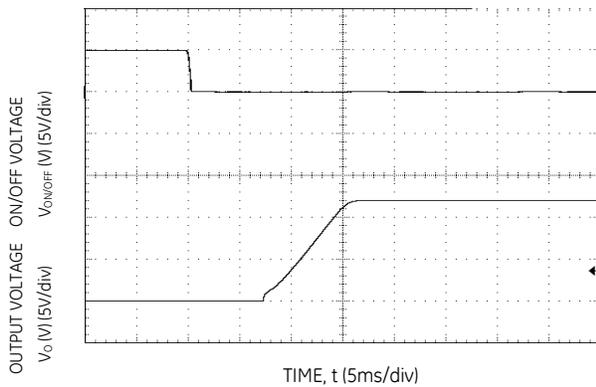

Figure 17. Typical Start-up Using On/Off Voltage ($I_o = I_{o,max}$).

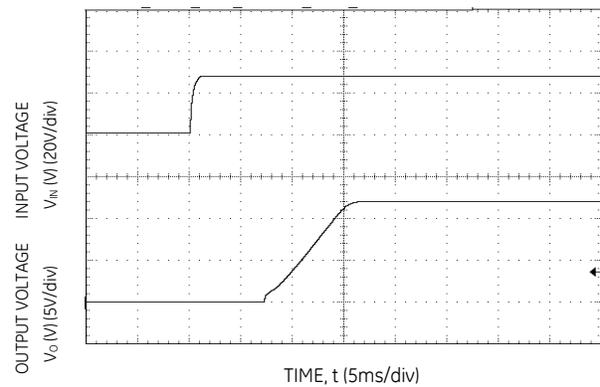

Figure 18. Typical Start-up Using Input Voltage ($V_{IN} = 28V$, $I_o = I_{o,max}$).

9-36V ProLynx™ 5A: Non-Isolated DC-DC Power Modules

9Vdc –36Vdc input; 3Vdc to 18Vdc output; 5A to 2.5A Scaled output current

9Vdc –24Vdc input; -3.3Vdc to -18Vdc output; 5A to 0.7A Scaled output current

Characteristic Curves

The following figures provide typical characteristics for the 9-36V ProLynx™ 5A at 18Vo and at 25°C. (2.5A rated output)

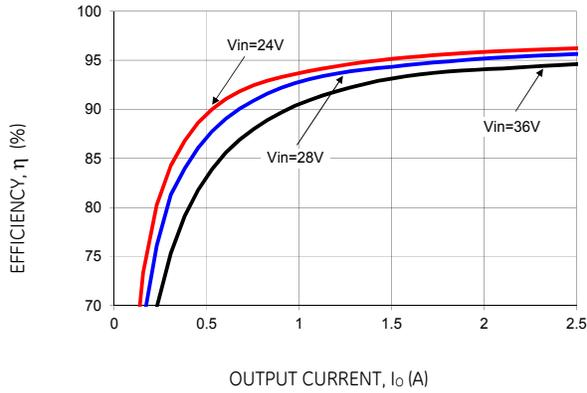

Figure 19. Converter Efficiency versus Output Current.

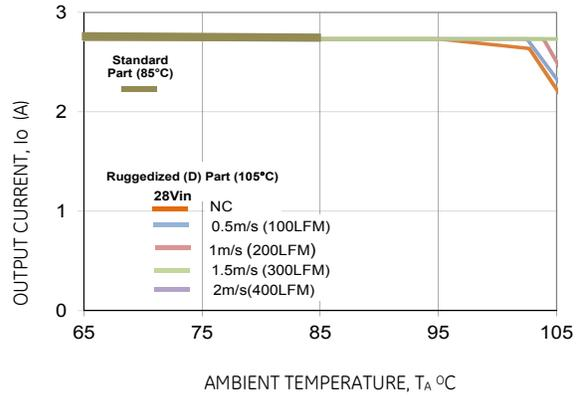

Figure 20. Derating Output Current versus Ambient Temperature and Airflow.

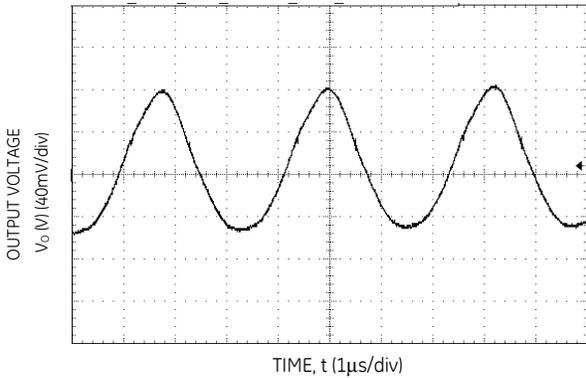

Figure 21. Typical output ripple and noise (VIN = 28V, Io = Io,max).

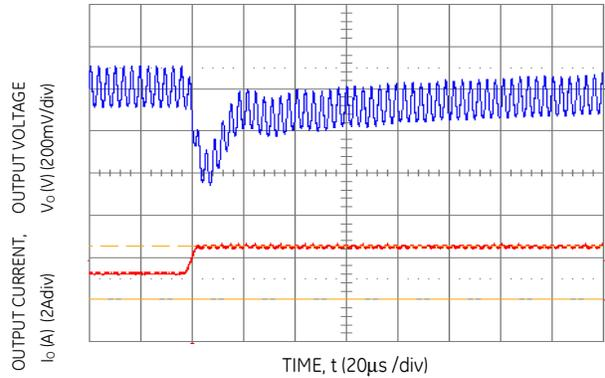

Figure 22. Transient Response to Dynamic Load Change from 50% to 100% at 28Vin, Cext = 1x10µF ceramic, CTune=150pF & RTune=220Ω

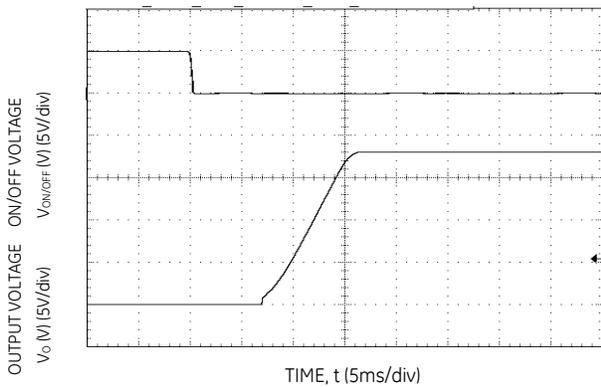

Figure 23. Typical Start-up Using On/Off Voltage (Io = Io,max).

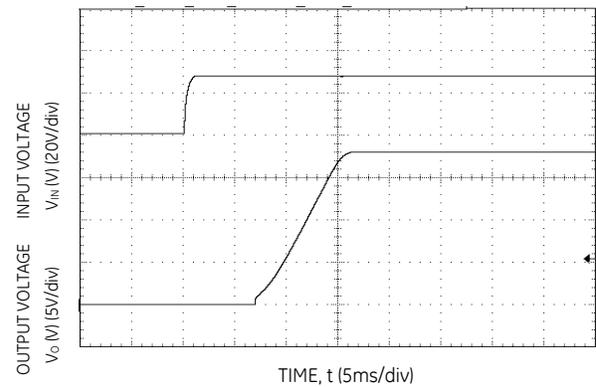

Figure 24. Typical Start-up Using Input Voltage (VIN = 28V, Io = Io,max).

9-36V ProLynx™ 5A: Non-Isolated DC-DC Power Modules

9Vdc –36Vdc input; 3Vdc to 18Vdc output; 5A to 2.5A Scaled output current

9Vdc –24Vdc input; -3.3Vdc to -18Vdc output; 5A to 0.7A Scaled output current

Test Configurations

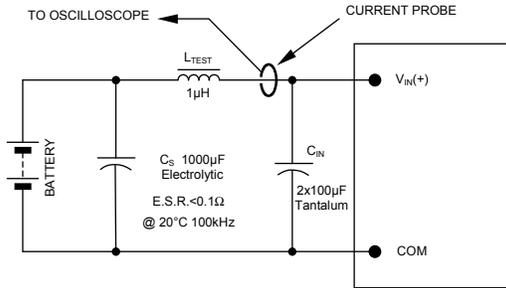

NOTE: Measure input reflected ripple current with a simulated source inductance (L_{TEST}) of 1µH. Capacitor C_S offsets possible battery impedance. Measure current as shown above.

Figure 25. Input Reflected Ripple Current Test Setup.

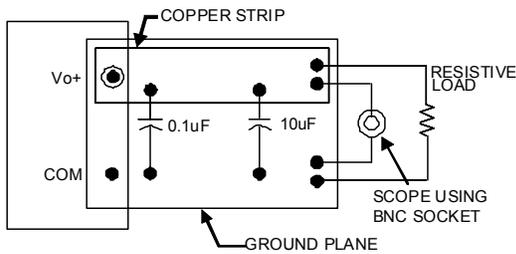

NOTE: All voltage measurements to be taken at the module terminals, as shown above. If sockets are used then Kelvin connections are required at the module terminals to avoid measurement errors due to socket contact resistance.

Figure 26. Output Ripple and Noise Test Setup.

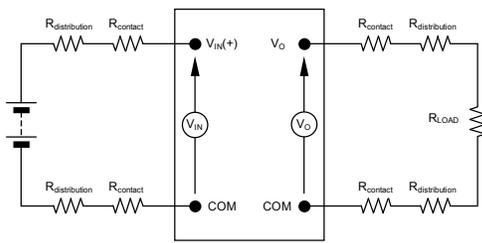

NOTE: All voltage measurements to be taken at the module terminals, as shown above. If sockets are used then Kelvin connections are required at the module terminals to avoid measurement errors due to socket contact resistance.

Figure 27. Output Voltage and Efficiency Test Setup.

$$\text{Efficiency } \eta = \frac{V_o \cdot I_o}{V_{IN} \cdot I_{IN}} \times 100 \%$$

Design Considerations

Input Filtering

The 9-36V ProLynx™ module should be connected to a low ac-impedance source. A highly inductive source can affect the stability of the module. An input capacitance must be placed directly adjacent to the input pin of the module, to minimize input ripple voltage and ensure module stability.

To minimize input voltage ripple, ceramic capacitors are recommended at the input of the module. Figure 28 shows the input ripple voltage for various output voltages at maximum load current with 2x10 µF or 3x10 µF ceramic capacitors and an input of 12V, while Fig. 29 shows the input ripple for an input voltage of 28V.

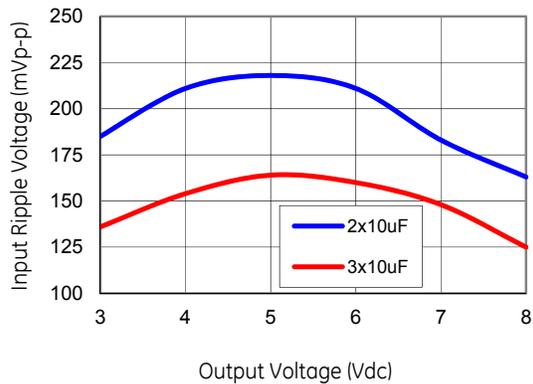

Figure 28. Input ripple voltage for various output voltages with 2x10 µF or 3x10 µF ceramic capacitors at the input (maximum load). Input voltage is 12V.

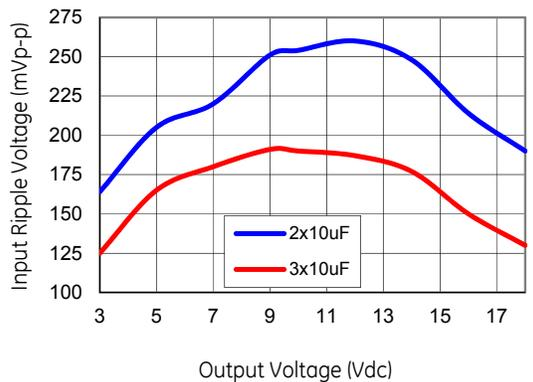

Figure 29. Input ripple voltage for various output voltages with 2x10 µF or 3x10 µF ceramic capacitors at the input (maximum load). Input voltage is 28V.

9-36V ProLynx™ 5A: Non-Isolated DC-DC Power Modules

9Vdc –36Vdc input; 3Vdc to 18Vdc output; 5A to 2.5A Scaled output current

9Vdc –24Vdc input; -3.3Vdc to -18Vdc output; 5A to 0.7A Scaled output current

Output Filtering

The 9-36V ProLynx™ modules are designed for low output ripple voltage and will meet the maximum output ripple specification with 0.1 μF ceramic and 10 μF ceramic capacitors at the output of the module. However, additional output filtering may be required by the system designer for a number of reasons. First, there may be a need to further reduce the output ripple and noise of the module. Second, the dynamic response characteristics may need to be customized to a particular load step change.

To reduce the output ripple and improve the dynamic response to a step load change, additional capacitance at the output can be used. Low ESR polymer and ceramic capacitors are recommended to improve the dynamic response of the module. Figures 30 and 31 provide output ripple information for different external capacitance values at various Vo and for full load currents. For stable operation of the module, limit the capacitance to less than the maximum output capacitance as specified in the electrical specification table. Optimal performance of the module can be achieved by using the Tunable Loop™ feature described later in this data sheet.

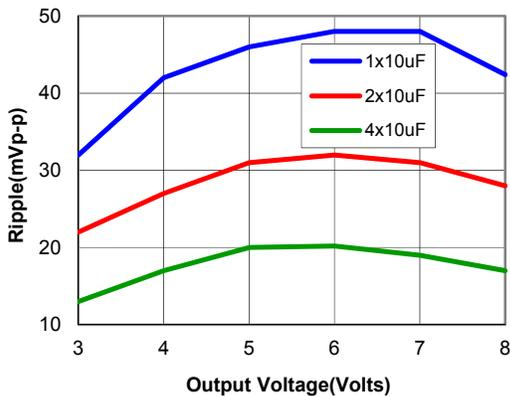

Figure 30. Output ripple voltage for various output voltages with external 1x10 μF, 2x10 μF or 4x10 μF ceramic capacitors at the output (max. load). Input voltage is 12V.

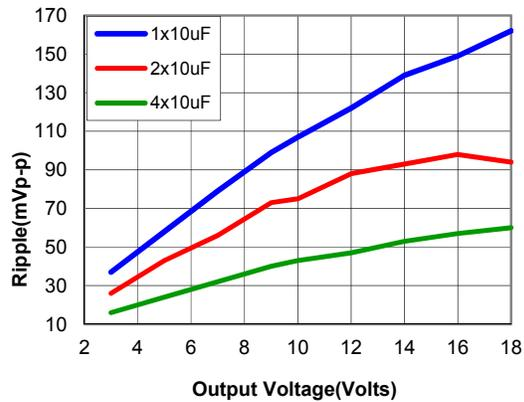

Figure 31. Output ripple voltage for various output voltages with external 1x10 μF, 2x10 μF or 4x10 μF ceramic capacitors at the output (max. load). Input voltage is 28V.

Safety Considerations

For safety agency approval the power module must be installed in compliance with the spacing and separation requirements of the end-use safety agency standards, i.e., UL 60950-1 2nd, CSA C22.2 No. 60950-1-07, DIN EN 60950-1:2006 + A11 (VDE0805 Teil 1 + A11):2009-11; EN 60950-1:2006 + A11:2009-03.

For the converter output to be considered meeting the requirements of safety extra-low voltage (SELV), the input must meet SELV requirements. The power module has extra-low voltage (ELV) outputs when all inputs are ELV.

The input to these units is to be provided with a fast-acting fuse with a maximum rating of 8A in the positive input lead.

9-36V ProLynx™ 5A: Non-Isolated DC-DC Power Modules

9Vdc –36Vdc input; 3Vdc to 18Vdc output; 5A to 2.5A Scaled output current

9Vdc –24Vdc input; -3.3Vdc to -18Vdc output; 5A to 0.7A Scaled output current

Once the unit goes into thermal shutdown it will then wait to cool before attempting to restart.

Input Undervoltage Lockout

At input voltages below the input undervoltage lockout limit, the module operation is disabled. The module will begin to operate at an input voltage above the undervoltage lockout turn-on threshold.

Output Voltage Programming

The output voltage of the 9-36V ProLynx™ module can be programmed to any voltage from 3Vdc to 18Vdc by connecting a resistor between the Trim and GND pins of the module. Certain restrictions apply on the output voltage set point depending on the input voltage. These are shown in the Output Voltage vs. Input Voltage Set Point Area plot in Fig. 35.

Without an external resistor between Trim and GND pins, the output of the module will be 0.7Vdc. To calculate the value of the trim resistor, R_{trim} for a desired output voltage, use the following equation:

$$R_{trim} = \left[\frac{70}{(V_o - 0.7)} \right] k\Omega$$

R_{trim} is the external resistor in $k\Omega$, and V_o is the desired output voltage.

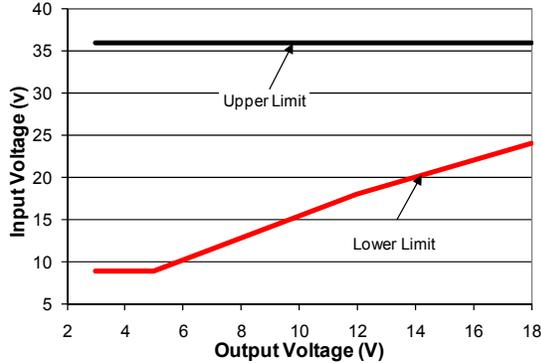

Figure 35. Output Voltage vs. Input Voltage Set Point Area plot showing limits where the output voltage can be set for different input voltages.

Table 1 provides R_{trim} values required for some common output voltages.

Table 1

$V_{o, set}$ (V)	R_{trim} (k Ω)
3.3	26.92
5	16.27
6	13.20
9	8.43
12	6.19
15	4.89
18	4.04

By using a $\pm 0.5\%$ tolerance trim resistor with a TC of ± 100 ppm, a set point tolerance of $\pm 1.5\%$ can be achieved as specified in the electrical specification.

Remote Sense

The 9-36V ProLynx™ power modules have a Remote Sense feature to minimize the effects of distribution losses by regulating the voltage between the VS+ and Vo pin. The voltage between the VS+ pin and Vo pin should not exceed 0.5V.

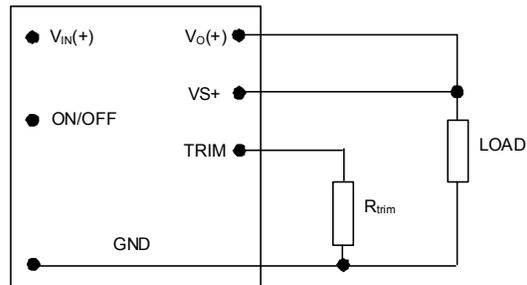

Figure 36. Circuit configuration for programming output voltage using an external resistor.

Voltage Margining

Output voltage margining can be implemented in the 9-36V ProLynx™ modules by connecting a resistor, $R_{margin-up}$, from the Trim pin to the ground pin for margining-up the output voltage and by connecting a resistor, $R_{margin-down}$, from the Trim pin to output pin for margining-down. Figure 37 shows the circuit configuration for output voltage margining. The POL Programming Tool, available at www.lineagepower.com under the Design Tools section, also calculates the values of $R_{margin-up}$ and $R_{margin-down}$ for a specific output voltage and % margin. Please consult your local GE technical representative for additional details.

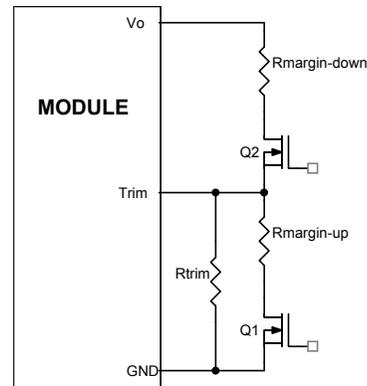

Figure 37. Circuit Configuration for margining Output voltage

9-36V ProLynx™ 5A: Non-Isolated DC-DC Power Modules

9Vdc –36Vdc input; 3Vdc to 18Vdc output; 5A to 2.5A Scaled output current

9Vdc –24Vdc input; -3.3Vdc to -18Vdc output; 5A to 0.7A Scaled output current

Tunable Loop™

The 9-36V ProLynx™ modules have a new feature that optimizes transient response of the module called Tunable Loop™.

External capacitors are usually added to the output of the module for two reasons: to reduce output ripple and noise (see Figs 30 and 31) and to reduce output voltage deviations from the steady-state value in the presence of dynamic load current changes. Adding external capacitance however affects the voltage control loop of the module, typically causing the loop to slow down with sluggish response. Larger values of external capacitance could also cause the module to become unstable.

The Tunable Loop™ allows the user to externally adjust the voltage control loop to match the filter network connected to the output of the module. The Tunable Loop™ is implemented by connecting a series R-C between the SENSE and TRIM pins of the module, as shown in Fig. 38. This R-C allows the user to externally adjust the voltage loop feedback compensation of the module.

Recommended values of R_{TUNE} and C_{TUNE} for different output capacitor combinations are given in Tables 2, 3 and 4. Tables 2 and 3 show recommended values of R_{TUNE} and C_{TUNE} for different values of ceramic output capacitors up to 100µF that might be needed for an application to meet output ripple and noise requirements. Selecting R_{TUNE} and C_{TUNE} according to Tables 2 and 3 will ensure stable operation of the module

In applications with tight output voltage limits in the presence of dynamic current loading, additional output capacitance will be required. Table 4 lists recommended values of R_{TUNE} and C_{TUNE} in order to meet 2% output voltage deviation limits for some common output voltages in the presence of a 50% of full load step change with an input voltage of 12 or 28V.

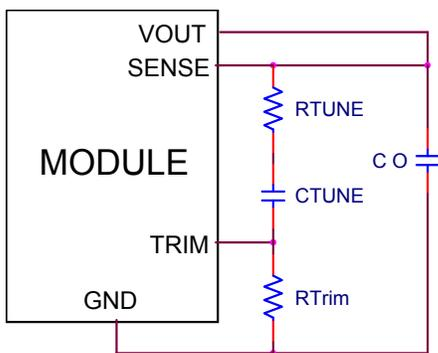

Figure 38. Circuit diagram showing connection of R_{TUNE} and C_{TUNE} to tune the control loop of the module.

Please contact your GE technical representative to obtain more details of this feature as well as for guidelines on how to select the right value of external R-C to tune the module for best transient performance and stable operation for other output capacitance values or input voltages other than 12 / 28V.

Table 2. General recommended values of R_{TUNE} and C_{TUNE} for $V_{in}=12V$ and various external ceramic capacitor combinations.

$V_o=5V$

C_o	1x10µF	1x22µF	2x22µF	4x22µF	6x22µF
R_{TUNE}	330	270	270	220	180
C_{TUNE}	680pF	1200pF	2700pF	4700pF	5600pF

Table 3. General recommended values of R_{TUNE} and C_{TUNE} for $V_{in}=28V$ and various external ceramic capacitor combinations.

$V_o=5V$

C_o	1x10µF	1x22µF	2x22µF	4x22µF	6x22µF
R_{TUNE}	330	220	220	150	150
C_{TUNE}	220pF	390pF	680pF	1000pF	1800pF

$V_o=12V$

C_o	1x10µF	1x22µF	2x22µF	4x22µF	6x22µF
R_{TUNE}	330	330	270	270	180
C_{TUNE}	120pF	470pF	1000pF	1800pF	2700pF

Table 4. Recommended values of R_{TUNE} and C_{TUNE} to obtain transient deviation of 2% of V_{out} for a 50% of full load step.

V_{in}	12V		28V			
V_o	3.3V	5V	3.3V	5V	12V	18V
ΔI	2.5A	2.35A	2.5A	2.35A	1.75A	1.5A
C_o	1x330µF OsCon	1x330µF OsCon	1x330µF OsCon	1x330µF OsCon	2x22µF	1x22µF
R_{TUNE}	180	180	180	220	270	330
C_{TUNE}	22nF	22nF	6800pF	6.8nF	470pF	47pF
ΔV	39mV	37mV	36mV	34mV	220mV	310mV

9-36V ProLynx™ 5A: Non-Isolated DC-DC Power Modules

9Vdc –36Vdc input; 3Vdc to 18Vdc output; 5A to 2.5A Scaled output current

9Vdc –24Vdc input; -3.3Vdc to -18Vdc output; 5A to 0.7A Scaled output current

Thermal Considerations

Power modules operate in a variety of thermal environments; however, sufficient cooling should always be provided to help ensure reliable operation.

Considerations include ambient temperature, airflow, module power dissipation, and the need for increased reliability. A reduction in the operating temperature of the module will result in an increase in reliability. The thermal data presented here is based on physical measurements taken in a wind tunnel. The test set-up is shown in Figure 39. The preferred airflow direction for the module is in Figure 40. The derating data applies to airflow in either direction of the module's short axis.

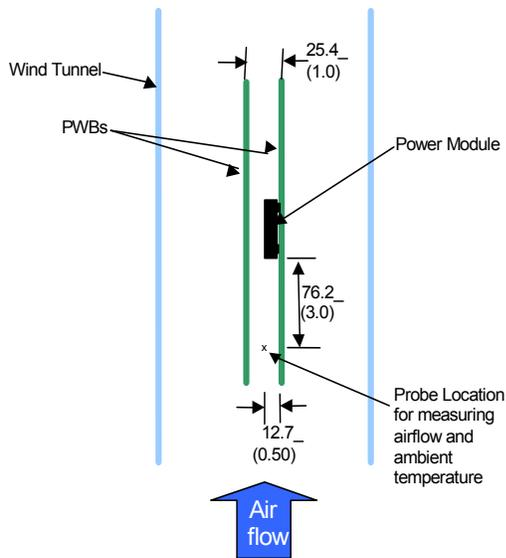

Figure 39. Thermal Test Setup.

The thermal reference points, T_{ref} used in the specifications are also shown in Figure 40. For reliable operation the temperatures at these points should not exceed 115°C. The output power of the module should not exceed the rated power of the module ($V_{o,set} \times I_{o,max}$).

Please refer to the Application Note “Thermal Characterization Process For Open-Frame Board-Mounted Power Modules” for a detailed discussion of thermal aspects including maximum device temperatures.

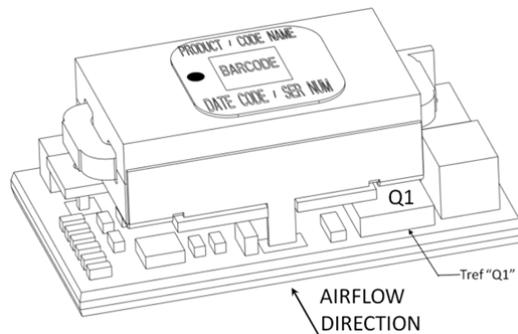

Figure 40. Preferred airflow direction and location of hot-spot of the module (T_{ref}).

9-36V ProLynx™ 5A: Non-Isolated DC-DC Power Modules

9Vdc –36Vdc input; 3Vdc to 18Vdc output; 5A to 2.5A Scaled output current

9Vdc –24Vdc input; -3.3Vdc to -18Vdc output; 5A to 0.7A Scaled output current

Shock and Vibration

The ruggedized (-D version) of the modules are designed to withstand elevated levels of shock and vibration to be able to operate in harsh environments. The ruggedized modules have been successfully tested to the following conditions:

Non operating random vibration:

Random vibration tests conducted at 25C, 10 to 2000Hz, for 30 minutes each level, starting from 30Grms (Z axis) and up to 50Grms (Z axis). The units were then subjected to two more tests of 50Grms at 30 minutes each for a total of 90 minutes.

Operating shock to 40G per Mil Std. 810F, Method 516.4 Procedure I:

The modules were tested in opposing directions along each of three orthogonal axes, with waveform and amplitude of the shock impulse characteristics as follows:

All shocks were half sine pulses, 11 milliseconds (ms) in duration in all 3 axes.

Units were tested to the Functional Shock Test of MIL-STD-810, Method 516.4, Procedure I - Figure 516.4-4. A shock magnitude of 40G was utilized. The operational units were subjected to three shocks in each direction along three axes for a total of eighteen shocks.

Operating vibration per Mil Std 810F, Method 514.5 Procedure I:

The ruggedized (-D version) modules are designed and tested to vibration levels as outlined in MIL-STD-810F, Method 514.5, and Procedure 1, using the Power Spectral Density (PSD) profiles as shown in Table 1 and Table 2 for all axes. Full compliance with performance specifications was required during the performance test. No damage was allowed to the module and full compliance to performance specifications was required when the endurance environment was removed. The module was tested per MIL-STD-810, Method 514.5, Procedure I, for functional (performance) and endurance random vibration using the performance and endurance levels shown in Table 5 and Table 6 for all axes. The performance test has been split, with one half accomplished before the endurance test and one half after the endurance test (in each axis). The duration of the performance test was at least 16 minutes total per axis and at least 120 minutes total per axis for the endurance test. The endurance test period was 2 hours minimum per axis.

Table 5: Performance Vibration Qualification - All Axes

Frequency (Hz)	PSD Level (G ² /Hz)	Frequency (Hz)	PSD Level (G ² /Hz)	Frequency (Hz)	PSD Level (G ² /Hz)
10	1.14E-03	170	2.54E-03	690	1.03E-03
30	5.96E-03	230	3.70E-03	800	7.29E-03
40	9.53E-04	290	7.99E-04	890	1.00E-03
50	2.08E-03	340	1.12E-02	1070	2.67E-03
90	2.08E-03	370	1.12E-02	1240	1.08E-03
110	7.05E-04	430	8.84E-04	1550	2.54E-03
130	5.00E-03	490	1.54E-03	1780	2.88E-03
140	8.20E-04	560	5.62E-04	2000	5.62E-04

Table 6: Endurance Vibration Qualification - All Axes

Frequency (Hz)	PSD Level (G ² /Hz)	Frequency (Hz)	PSD Level (G ² /Hz)	Frequency (Hz)	PSD Level (G ² /Hz)
10	0.00803	170	0.01795	690	0.00727
30	0.04216	230	0.02616	800	0.05155
40	0.00674	290	0.00565	890	0.00709
50	0.01468	340	0.07901	1070	0.01887
90	0.01468	370	0.07901	1240	0.00764
110	0.00498	430	0.00625	1550	0.01795
130	0.03536	490	0.01086	1780	0.02035
140	0.0058	560	0.00398	2000	0.00398

9-36V ProLynx™ 5A: Non-Isolated DC-DC Power Modules

9Vdc –36Vdc input; 3Vdc to 18Vdc output; 5A to 2.5A Scaled output current

9Vdc –24Vdc input; -3.3Vdc to -18Vdc output; 5A to 0.7A Scaled output current

Example Application Circuit

Requirements:

Vin:	28V
Vout:	12V
Iout:	2.6A max., worst case load transient is from 1.75A to 2.6A
ΔVout:	1.5% of Vout (180mV) for worst case load transient
Vin, ripple	1.5% of Vin (420mV, p-p)

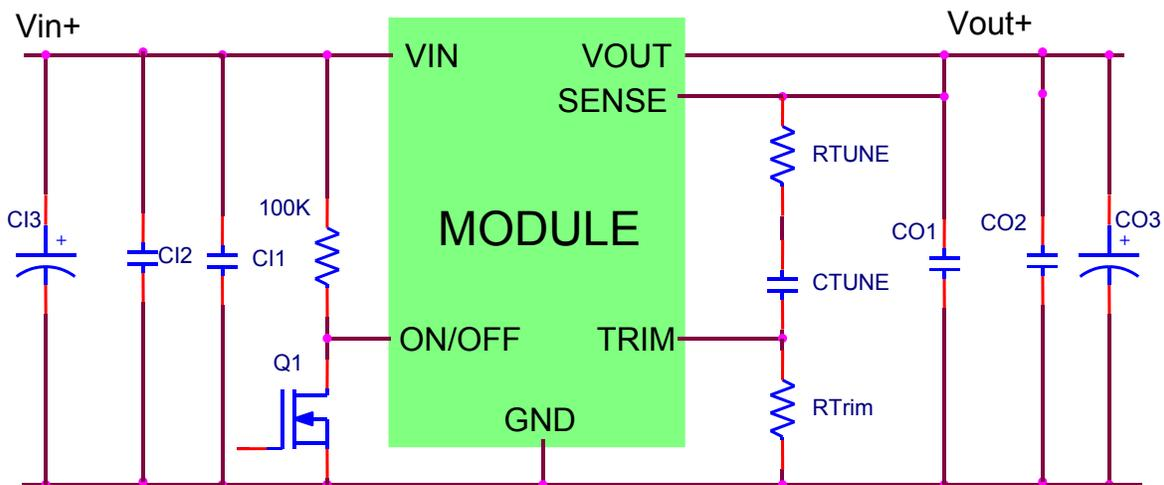

C11	1 × 0.01μF/50V, 0603 ceramic capacitor
C12	2 × 10μF/50V ceramic capacitor (e.g. Murata GRM32ER71H106K)
C13	47μF/63V bulk electrolytic
CO1	1 × 0.01μF/25V, 0306 ceramic capacitor (e.g. Murata LLL185R71E103MA01L)
CO2	2 × 10μF/25V ceramic capacitor (e.g. Murata GCM32ER71E106KA42)
CO3	NA
CTune	470pF ceramic capacitor (can be 1206, 0805 or 0603 size)
RTune	150 ohms SMT resistor (can be 1206, 0805 or 0603 size)
RTrim	6.19KΩ resistor

9-36V ProLynx™ 5A: Non-Isolated DC-DC Power Modules
 9Vdc -36Vdc input; 3Vdc to 18Vdc output; 5A to 2.5A Scaled output current
 9Vdc -24Vdc input; -3.3Vdc to -18Vdc output; 5A to 0.7A Scaled output current

Mechanical Outline

Dimensions are in millimeters and (inches).

Tolerances: x.x mm ± 0.5 mm (x.xx in. ± 0.02 in.) [unless otherwise indicated]

x.xx mm ± 0.25 mm (x.xxx in ± 0.010 in.)

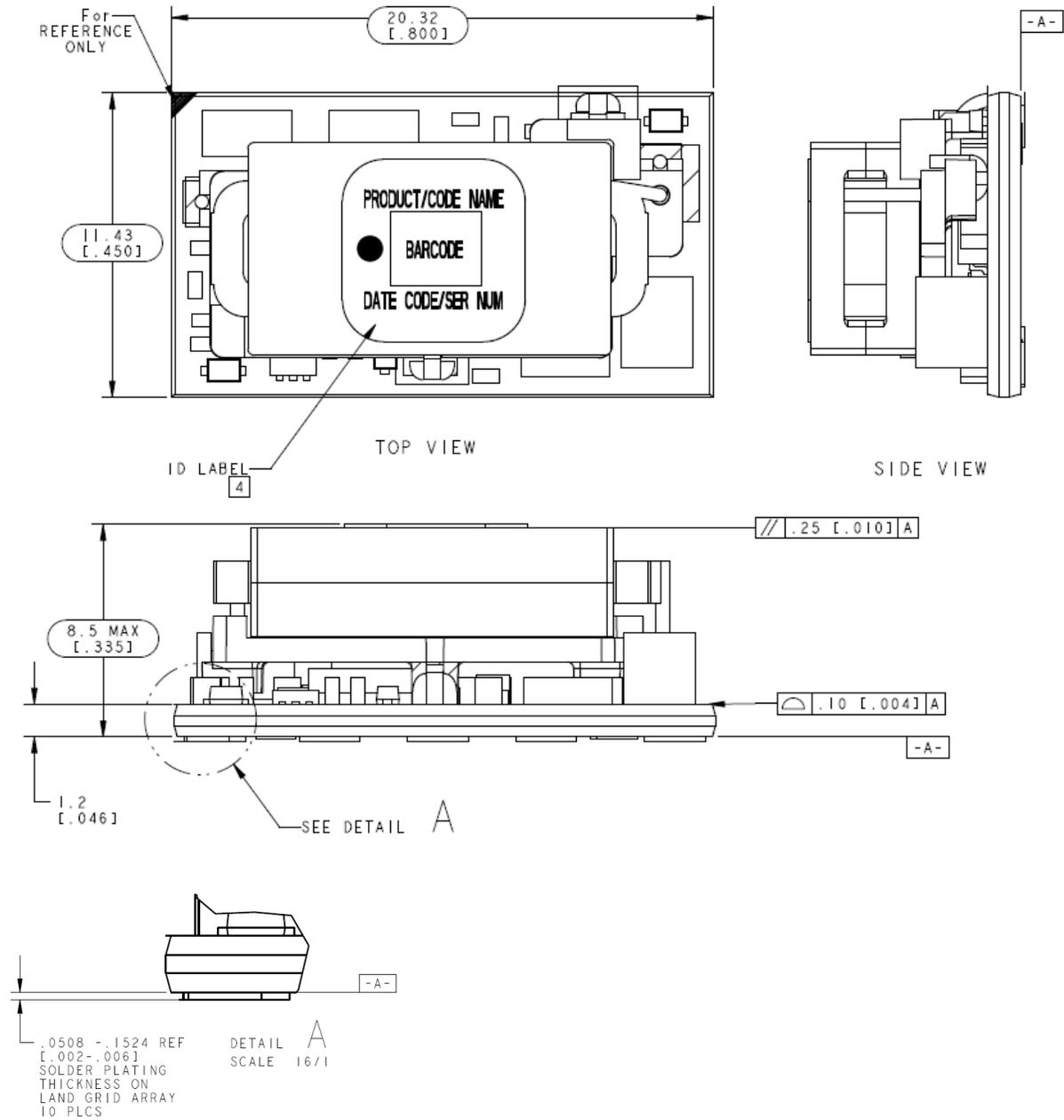

9-36V ProLynx™ 5A: Non-Isolated DC-DC Power Modules

9Vdc –36Vdc input; 3Vdc to 18Vdc output; 5A to 2.5A Scaled output current
 9Vdc –24Vdc input; -3.3Vdc to -18Vdc output; 5A to 0.7A Scaled output current

Recommended Pad Layout

Dimensions are in millimeters and (inches).

Tolerances: x.x mm ± 0.5 mm (x.xx in. ± 0.02 in.) [unless otherwise indicated]

x.xx mm ± 0.25 mm (x.xxx in ± 0.010 in.)

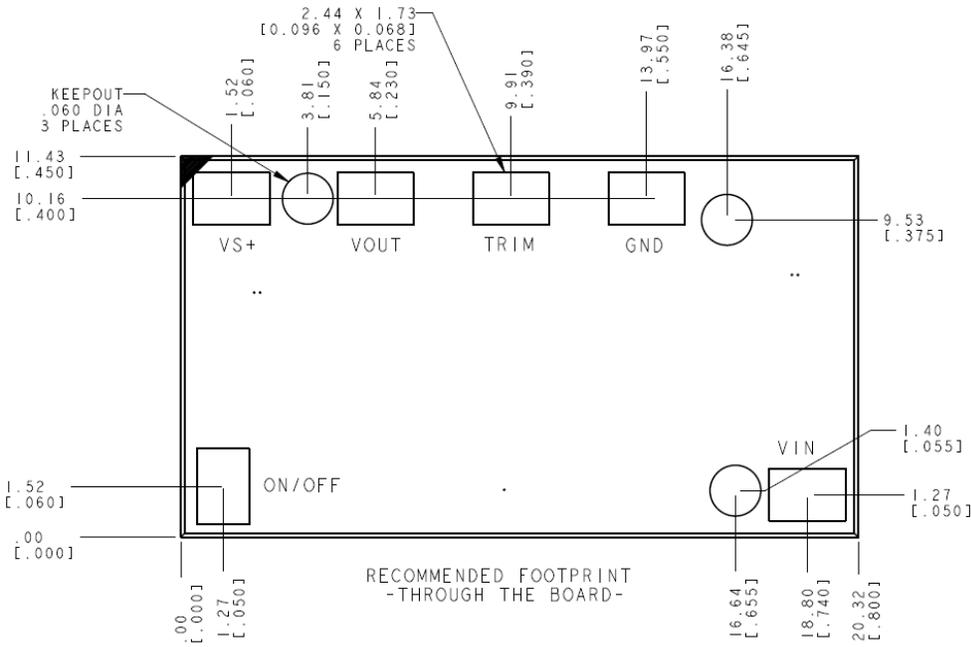

PIN	FUNCTION
1	ON/OFF
2	VIN
3	GND
4	TRIM
5	VOUT
6	VS+

9-36V ProLynx™ 5A: Non-Isolated DC-DC Power Modules
 9Vdc –36Vdc input; 3Vdc to 18Vdc output; 5A to 2.5A Scaled output current
 9Vdc –24Vdc input; -3.3Vdc to -18Vdc output; 5A to 0.7A Scaled output current

Packaging Details

The 9-36V ProLynx™ modules are supplied in tape & reel as standard. Modules are shipped in quantities of 250 modules per reel.

All Dimensions are in millimeters and (in inches).

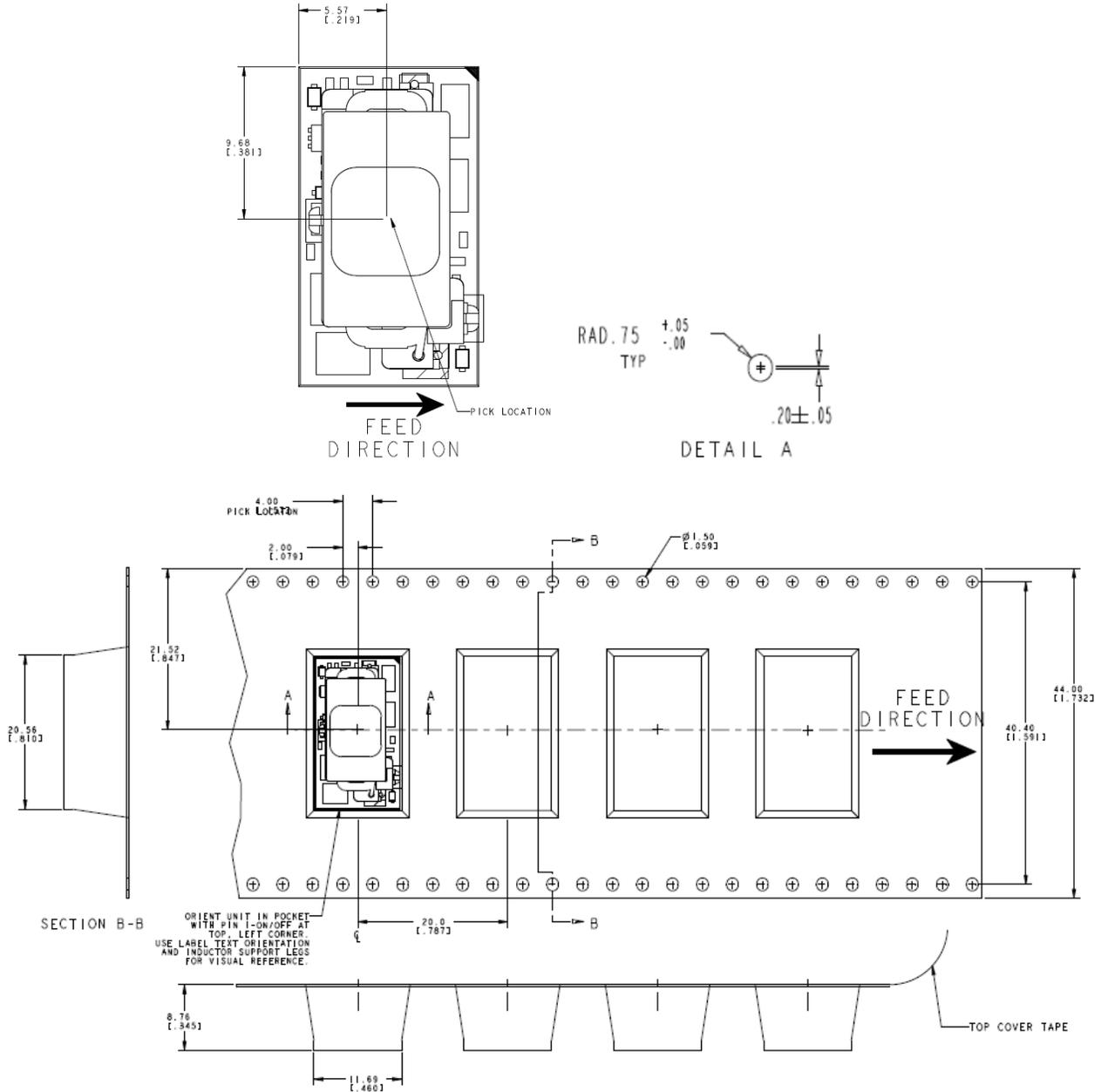

- Reel Dimensions:
- Outside Dimensions: 330.2 mm (13.00)
- Inside Dimensions: 177.8 mm (7.00")
- Tape Width: 44.00 mm (1.732")

9-36V ProLynx™ 5A: Non-Isolated DC-DC Power Modules

9Vdc –36Vdc input; 3Vdc to 18Vdc output; 5A to 2.5A Scaled output current

9Vdc –24Vdc input; -3.3Vdc to -18Vdc output; 5A to 0.7A Scaled output current

Surface Mount Information

Pick and Place

The 9-36V ProLynx™ modules use an open frame construction and are designed for a fully automated assembly process. The modules are fitted with a label designed to provide a large surface area for pick and place operations. The label meets all the requirements for surface mount processing, as well as safety standards, and is able to withstand reflow temperatures of up to 300°C. The label also carries product information such as product code, serial number and the location of manufacture.

Nozzle Recommendations

The module weight has been kept to a minimum by using open frame construction. Variables such as nozzle size, tip style, vacuum pressure and placement speed should be considered to optimize this process. The minimum recommended inside nozzle diameter for reliable operation is 3mm. The maximum nozzle outer diameter, which will safely fit within the allowable component spacing, is 7 mm.

Bottom Side / First Side Assembly

This module is not recommended for assembly on the bottom side of a customer board. If such an assembly is attempted, components may fall off the module during the second reflow process.

Lead Free Soldering

The 9-36V ProLynx™ modules are lead-free (Pb-free) and RoHS compliant and fully compatible in a Pb-free soldering process. Failure to observe the instructions below may result in the failure of or cause damage to the modules and can adversely affect long-term reliability.

Pb-free Reflow Profile

Power Systems will comply with J-STD-020 Rev. C (Moisture/Reflow Sensitivity Classification for Nonhermetic Solid State Surface Mount Devices) for both Pb-free solder profiles and MSL classification procedures. This standard provides a recommended forced-air-convection reflow profile based on the volume and thickness of the package (table 4-2). The suggested Pb-free solder paste is Sn/Ag/Cu (SAC). The recommended linear reflow profile using Sn/Ag/Cu solder is shown in Fig. 41. Soldering outside of the recommended profile requires testing to verify results and performance.

For questions regarding Land grid array(LGA) soldering, solder volume; please contact GE for special manufacturing process instructions.

MSL Rating

The 9-36V ProLynx™ modules have a MSL rating of 2a.

Storage and Handling

The recommended storage environment and handling procedures for moisture-sensitive surface mount packages is detailed in J-STD-033 Rev. A (Handling, Packing, Shipping and Use of Moisture/Reflow Sensitive Surface Mount Devices). Moisture barrier bags (MBB) with desiccant are required for MSL ratings of 2 or greater. These sealed packages should not be broken until time of use. Once the original package is broken, the floor life of the product at conditions of $\leq 30^{\circ}\text{C}$ and 60% relative humidity varies according to the MSL rating (see J-STD-033A). The shelf life for dry packed SMT packages will be a minimum of 12 months from the bag seal date, when stored at the following conditions: $< 40^{\circ}\text{C}$, $< 90\%$ relative humidity.

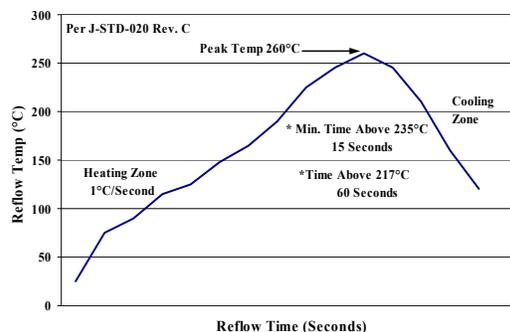

Figure 41. Recommended linear reflow profile using Sn/Ag/Cu solder.

Post Solder Cleaning and Drying Considerations

Post solder cleaning is usually the final circuit-board assembly process prior to electrical board testing. The result of inadequate cleaning and drying can affect both the reliability of a power module and the testability of the finished circuit-board assembly. For guidance on appropriate soldering, cleaning and drying procedures, refer to *Board Mounted Power Modules: Soldering and Cleaning Application Note (AN04-001)*.

9-36V ProLynx™ 5A: Non-Isolated DC-DC Power Modules

9Vdc –36Vdc input; 3Vdc to 18Vdc output; 5A to 2.5A Scaled output current
 9Vdc –24Vdc input; -3.3Vdc to -18Vdc output; 5A to 0.7A Scaled output current

EMC Considerations

The circuit and plots in Figure 42 shows a suggested configuration to meet the radiated emission limits of EN55022 Class A. Actual performance depends on layout and external components used.

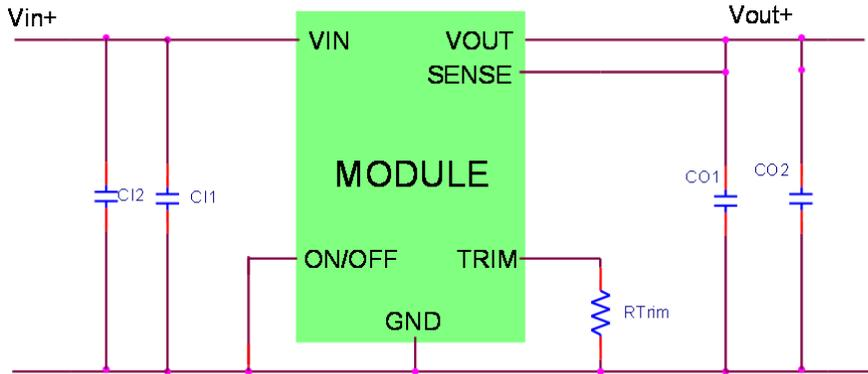

- C11 1 x 0.01µF/50V, 0603 ceramic capacitor
- C12 2 x 10µF/50V ceramic capacitor (e.g. Murata GRM32ER71H106K)
- CO1 1 x 0.01µF/25V, 0306 ceramic capacitor (e.g. Murata LLL185R71E103MA01L)
- CO2 2 x 10µF/25V ceramic capacitor (e.g. Murata GCM32ER71E106KA42)
- RTrim 6.19KΩ resistor

EUT: APXW005A0X3-SRZ / TEM Cell

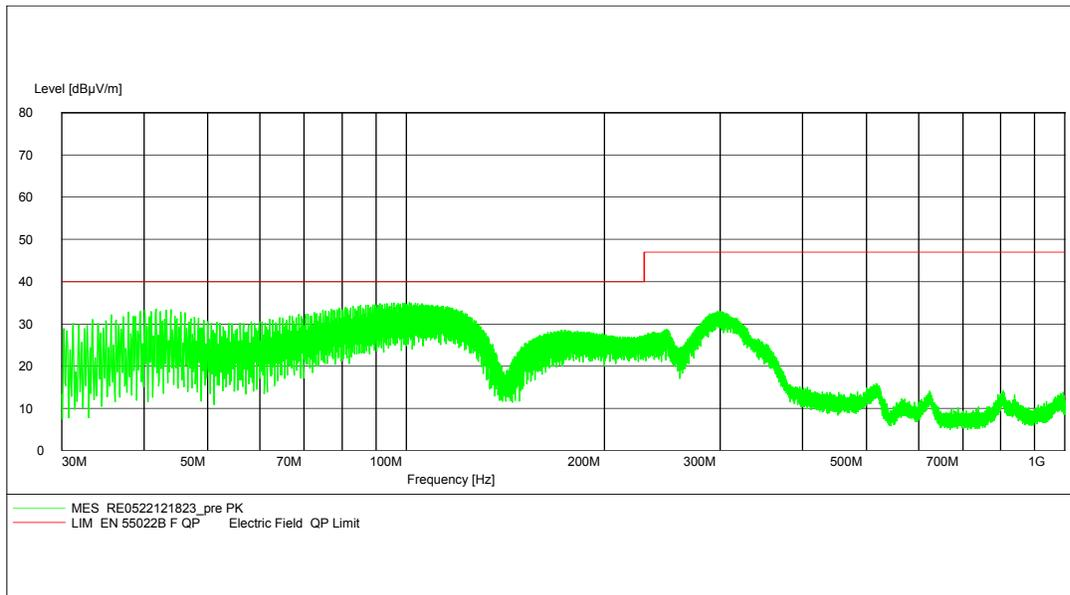

Fig 42 – EMI Plot of APXW005 on evaluation board with 12 V in @ 1.8 A in / 5 Vdc @ 4 A out

9-36V ProLynx™ 5A: Non-Isolated DC-DC Power Modules

9Vdc –36Vdc input; 3Vdc to 18Vdc output; 5A to 2.5A Scaled output current

9Vdc –24Vdc input; -3.3Vdc to -18Vdc output; 5A to 0.7A Scaled output current

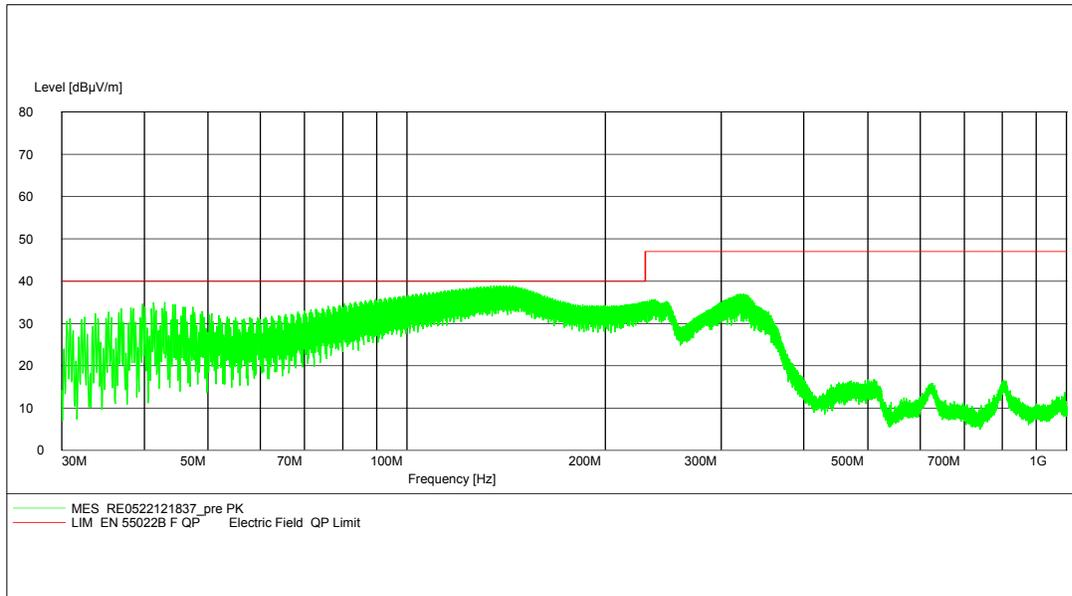

Fig 43 – EMI Plot of APXW005 on evaluation board with 24 V in @ 0.9 A in / 5 Vdc @ 4 A out

9-36V ProLynx™ 5A: Non-Isolated DC-DC Power Modules

9Vdc –36Vdc input; 3Vdc to 18Vdc output; 5A to 2.5A Scaled output current

9Vdc –24Vdc input; -3.3Vdc to -18Vdc output; 5A to 0.7A Scaled output current

Negative Output Operation

Basic Scheme

The 9-36V ProLynx™ modules can also be used to create negative output voltages from a positive input voltage. Changing the input connection to as shown in Figure 44 converts the module from a synchronous buck converter to a synchronous flyback converter

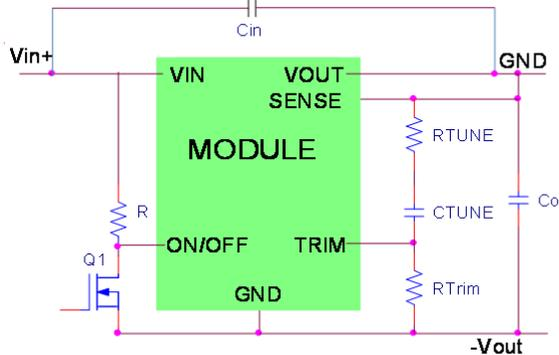

Figure 44. Schematic Connection of 5A ProLynx module for negative output applications.

Remote Enable

Figures 33 and 34 still apply for remote On/Off operation. However the On/Off threshold is now with respect to -Vout instead of Ground. Before the module turns on, output is zero so GND and -Vout are at the same potential. After the module turns on, -Vout moves down and so will the ON/OFF threshold. The following level shifting circuit can be used in applications to limit exposure of the negative output voltage to the On/Off circuitry.

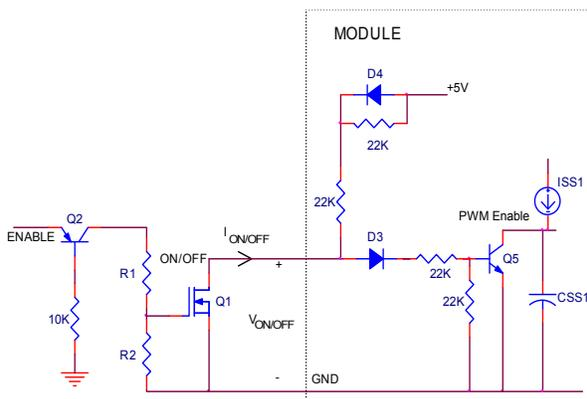

Figure 45. On/Off Level Shifting Circuit for the 5A ProLynx module for negative output applications.

Instead of directly turning Q1 On, the level shifting circuit is used to turn Q1 On by first turning Q2 ON. When Q1 is in the ON state, the ON/OFF pin is pulled low causing transistor Q5 to be OFF and the module to be turned ON. Both Q1 and Q2 are external transistors. To turn the module OFF, Q2 is turned

OFF, which turns Q1 OFF causing the ON/OFF pin to be pulled high turning Q5 ON and the module to be turned OFF. If the On/Off pin is left floating, the module will be in the OFF state.

Input Voltage Range

The 9-36V ProLynx™ modules when connected in a negative output application will support a maximum input voltage which is also a function of the output voltage. The sum of the applied input voltage and magnitude of the output voltage cannot exceed 36V. $V_{in}(\text{applied}) + |V_{out}| \leq 36$ and $V_{out} \leq -3V$. For e.g. with a -12V output system the max input voltage that can be applied is only 24V. However, Figure 35 showing variation of output voltage with Input Voltage should still be considered for determining the required minimum input voltage.

Input voltage turn-on threshold remains the same as the positive output connection. However the input turn-off threshold tracks the output voltage and is reduced by the same level. The listed input Turn-Off threshold of 7.35V when applied to a -3.3Vout application will be measured as a 4.05V (7.35V - 3.3V) threshold. Operating at input voltages below 9V may cause the module to shut down earlier due to OCP inception

Output Voltage Range

The 9-36V ProLynx™ modules will support the values of trim resistors indicated in Table 1 to generate the same output voltage, except with sign inversion. For an output voltage of 12V or higher the maximum input voltage will have to be proportionally reduced from 24Vin so that the sum of the magnitudes does not exceed 36V

Overcurrent Protection

The 9-36V ProLynx modules will automatically scale current limit with output voltage through an inverse relationship of the current limit threshold even in negative output voltage mode. This feature is shown graphically in Fig. 46, allows higher output currents to be drawn from the module at lower output voltages thereby optimizing the power delivery capability of the module.

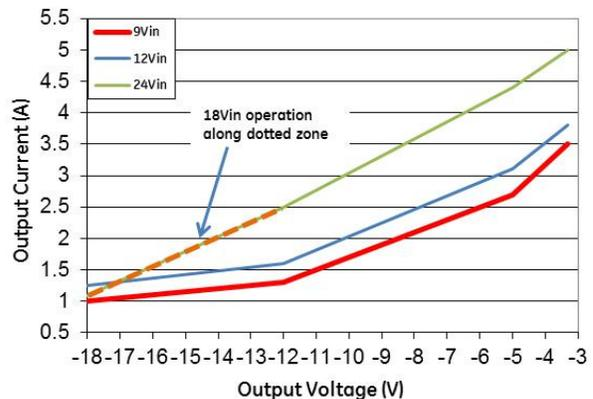

Figure 46. Graph showing maximum output current capability at different output voltages.

9-36V ProLynx™ 5A: Non-Isolated DC-DC Power Modules

9Vdc –36Vdc input; 3Vdc to 18Vdc output; 5A to 2.5A Scaled output current

9Vdc –24Vdc input; -3.3Vdc to -18Vdc output; 5A to 0.7A Scaled output current

Efficiency

9-36V ProLynx modules in a negative output application

-3.3Vout and at 25°C

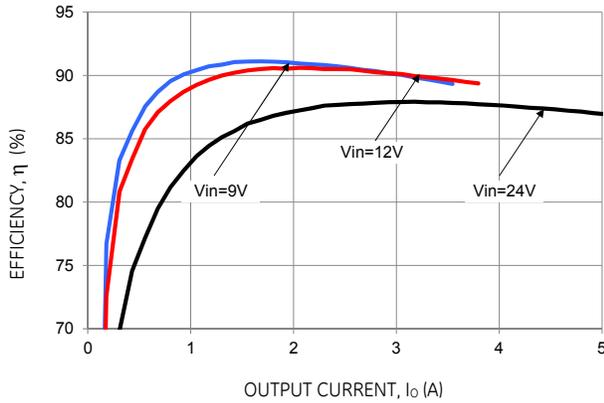

Figure 47. Converter Efficiency versus Output Current.

-12Vout and at 25°C

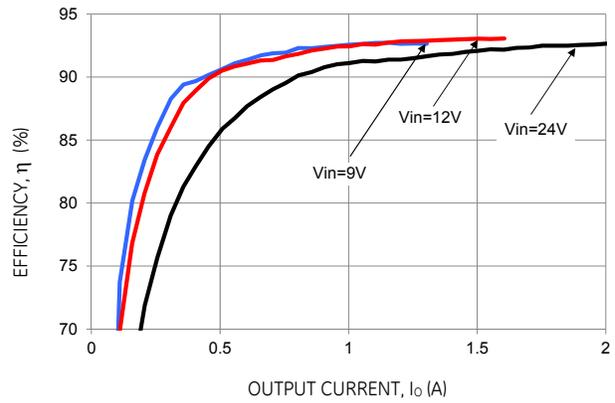

Figure 49. Converter Efficiency versus Output Current.

-5Vout and at 25°C

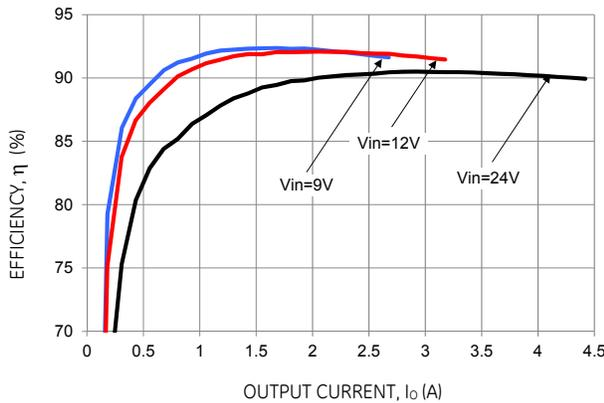

Figure 48. Converter Efficiency versus Output Current.

-18Vout and at 25°C

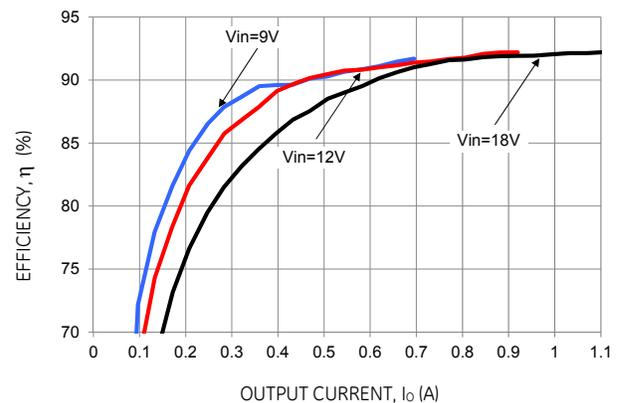

Figure 50. Converter Efficiency versus Output Current.

9-36V ProLynx™ 5A: Non-Isolated DC-DC Power Modules

9Vdc –36Vdc input; 3Vdc to 18Vdc output; 5A to 2.5A Scaled output current

9Vdc –24Vdc input; -3.3Vdc to -18Vdc output; 5A to 0.7A Scaled output current

Thermal

Thermal Derating curves for some of the output voltage settings when the 9-36V ProLynx modules are connected in a negative output application. De-rating curves for -3.3Vout, -5Vout, -12Vout and -18Vout have been provided for input voltages of 9Vin, 12Vin and 24Vin. Intermediate voltages can be estimated through extrapolation of provided data

9Vin, -3.3Vout

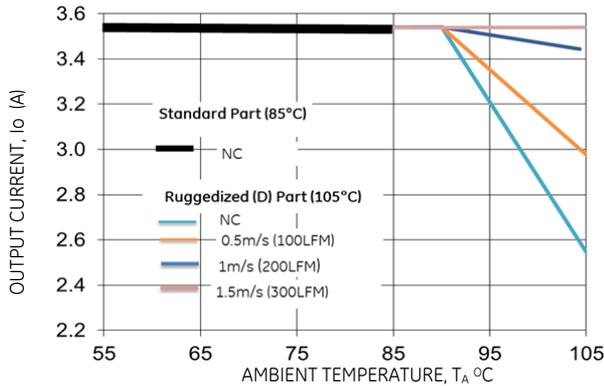

Figure 51. Derating Output Current versus Ambient Temperature and Airflow.

12Vin, -3.3Vout

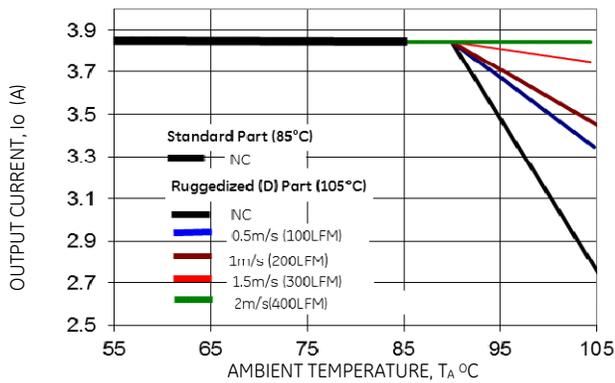

Figure 52. Derating Output Current versus Ambient Temperature and Airflow.

24Vin, -3.3Vout

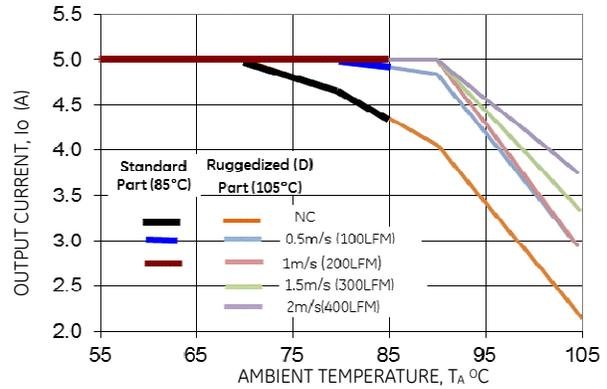

Figure 53. Derating Output Current versus Ambient Temperature and Airflow.

9Vin, -5Vout

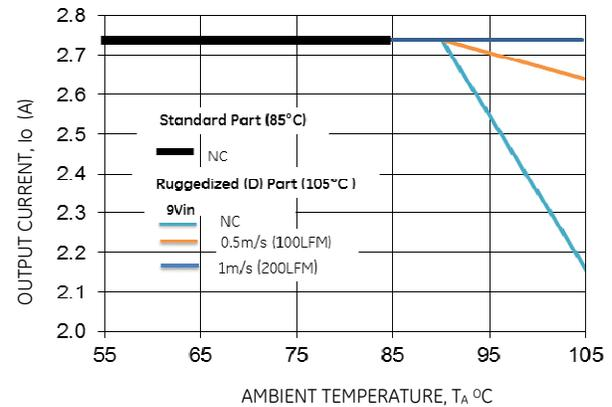

Figure 54. Derating Output Current versus Ambient Temperature and Airflow.

12Vin, -5Vout

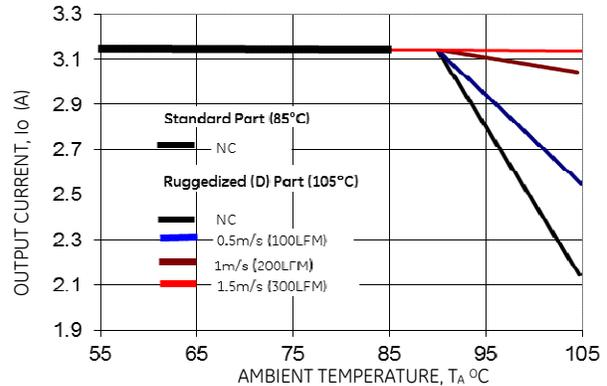

Figure 55. Derating Output Current versus Ambient Temperature and Airflow.

9-36V ProLynx™ 5A: Non-Isolated DC-DC Power Modules

9Vdc –36Vdc input; 3Vdc to 18Vdc output; 5A to 2.5A Scaled output current

9Vdc –24Vdc input; -3.3Vdc to -18Vdc output; 5A to 0.7A Scaled output current

24Vin, -5Vout

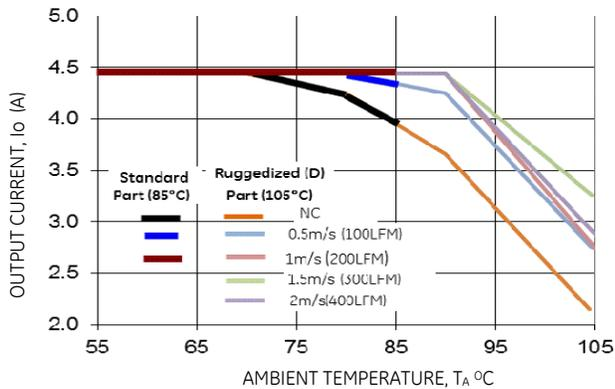

Figure 56. Derating Output Current versus Ambient Temperature and Airflow.

24Vin, -12Vout

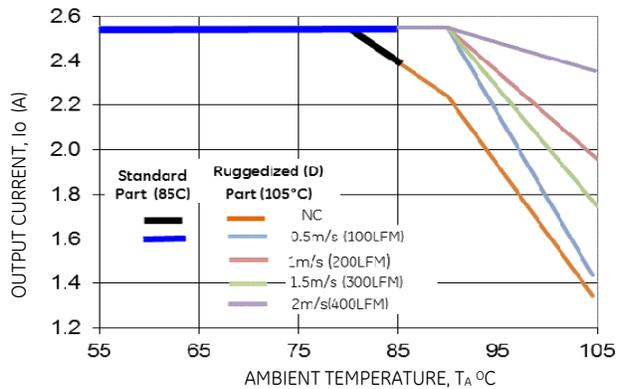

Figure 59. Derating Output Current versus Ambient Temperature and Airflow.

9Vin, -12Vout

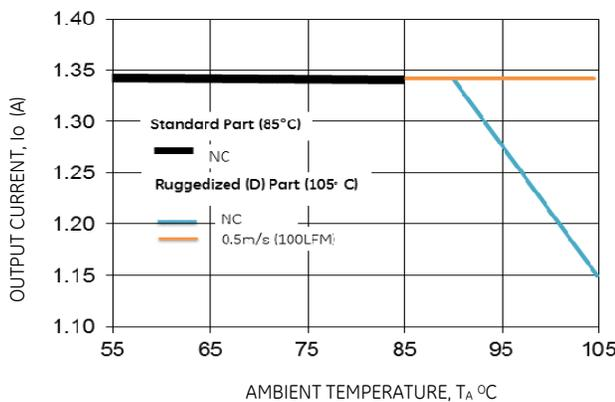

Figure 57. Derating Output Current versus Ambient Temperature and Airflow.

9Vin, -18Vout

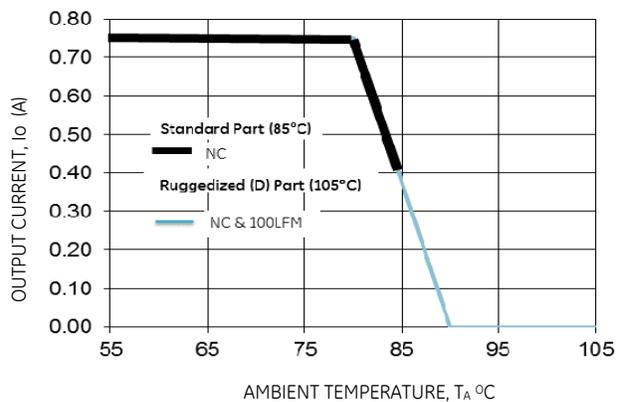

Figure 60. Derating Output Current versus Ambient Temperature and Airflow.

12Vin, -12Vout

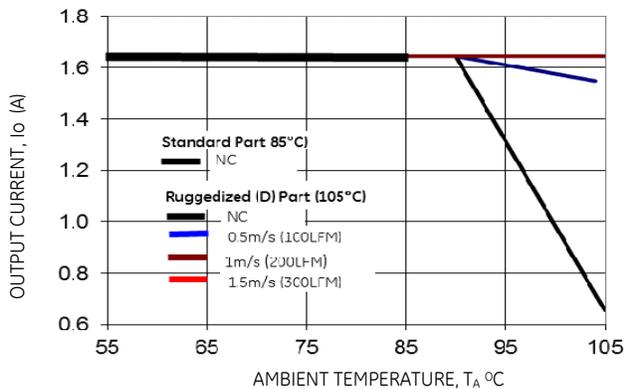

Figure 58. Derating Output Current versus Ambient Temperature and Airflow.

12Vin, -18Vout

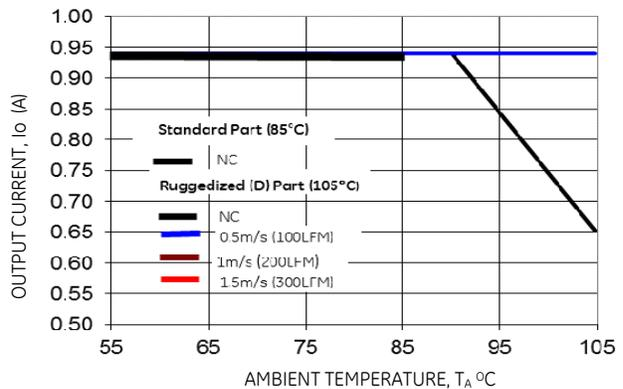

Figure 61. Derating Output Current versus Ambient Temperature and Airflow.

9-36V ProLynx™ 5A: Non-Isolated DC-DC Power Modules

9Vdc –36Vdc input; 3Vdc to 18Vdc output; 5A to 2.5A Scaled output current

9Vdc –24Vdc input; -3.3Vdc to -18Vdc output; 5A to 0.7A Scaled output current

18Vin, -18Vout

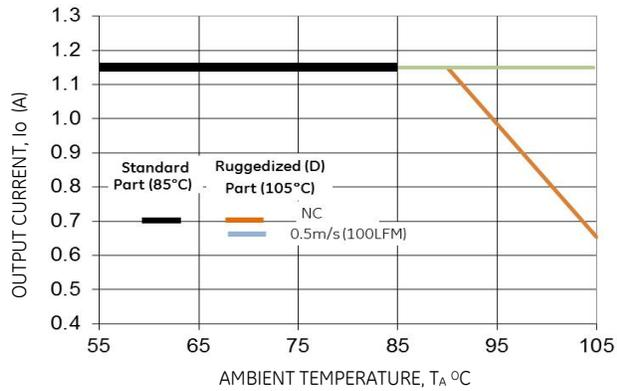

Figure 62. Derating Output Current versus Ambient Temperature and Airflow.

9-36V ProLynx™ 5A: Non-Isolated DC-DC Power Modules

9Vdc –36Vdc input; 3Vdc to 18Vdc output; 5A to 2.5A Scaled output current

9Vdc –24Vdc input; -3.3Vdc to -18Vdc output; 5A to 0.7A Scaled output current

Input Ripple

Input ripple curves have been provided for input voltages of 9Vin, 12Vin and 18Vin/24Vin.

Ripple at intermediate input voltages can be estimated through extrapolation of provided curves

9Vin

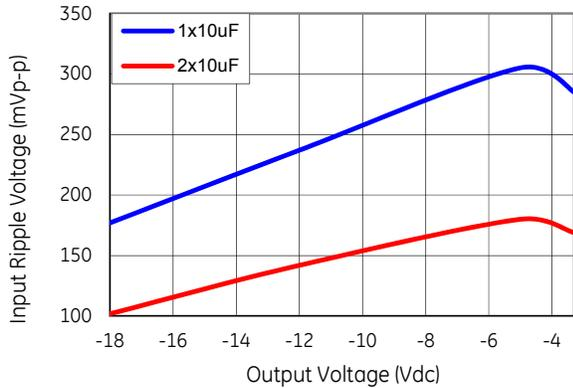

Figure 63. Input ripple voltage with 1x10 μF or 2x10 μF ceramic capacitors at the input (max load).

18Vin(-12Vo to -18Vo) / 24Vin(-3.3Vo to -12Vo)

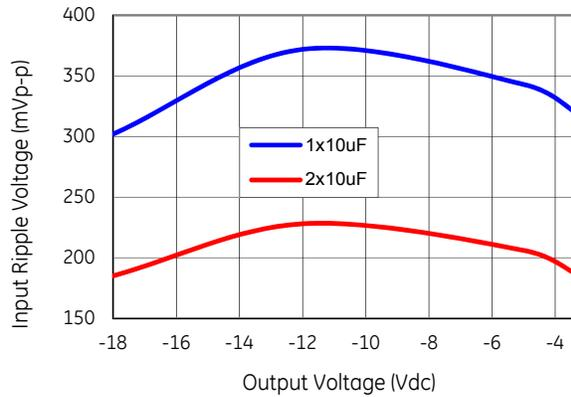

Figure 65. Input ripple voltage with 1x10 μF or 2x10 μF input ceramic capacitors (max load).

12Vin

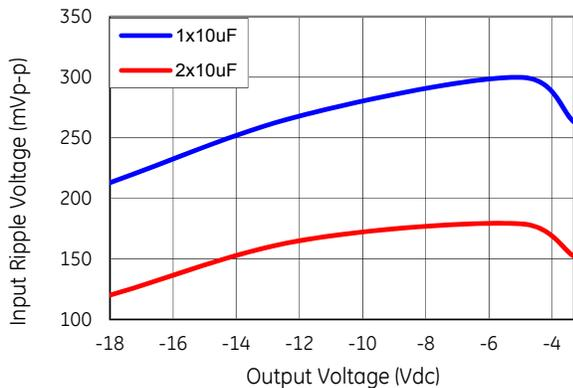

Figure 64. Input ripple voltage with 1x10 μF or 2x10 μF ceramic capacitors at the input (max load).

9-36V ProLynx™ 5A: Non-Isolated DC-DC Power Modules

9Vdc –36Vdc input; 3Vdc to 18Vdc output; 5A to 2.5A Scaled output current

9Vdc –24Vdc input; -3.3Vdc to -18Vdc output; 5A to 0.7A Scaled output current

Output Ripple

Output ripple curves for input voltages of 9Vin, 12Vin and 24Vin

Ripple at intermediate input voltages can be estimated through extrapolation. Output Voltage is also roughly proportional to load current level.

Table 7. Peak to Peak Ripple in mV with a 10uF external capacitor at different load levels

-3.3Vout			
	0.1A	50%Load	100%Load
9Vin	23	103 (1.75A)	174
12Vin	26	109 (1.9A)	177
24Vin	36	134 (2.5A)	214
-5Vout			
	0.1A	50%Load	100%Load
9Vin	27	114 (1.35A)	196
12Vin	31	115 (1.55A)	195
24Vin	40	127 (2.2A)	217
-12Vout			
	0.1A	50%Load	100%Load
9Vin	35	108 (0.65A)	195
12Vin	44	107 (0.8A)	206
24Vin	74	114 (1.25A)	217
-18Vout			
	0.1A	50%Load	100%Load
9Vin	43	77 (0.35A)	165
12Vin	53	80 (0.45A)	165
18Vin	76	122 (0.55A)	210

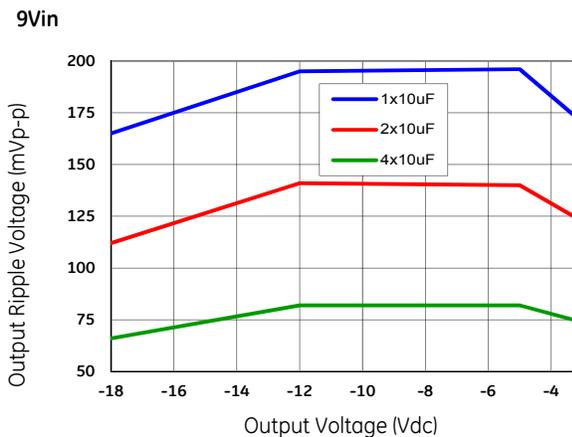

Figure 66. Output ripple with 1x10µF, 2x10µF or 4x10µF output ceramic capacitors (max load).

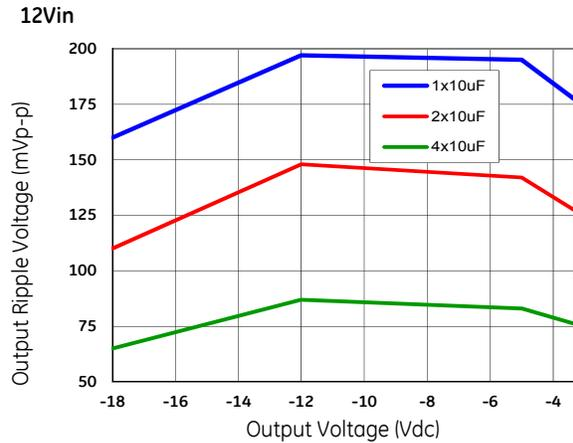

Figure 67. Output ripple with 1x10µF, 2x10µF or 4x10µF output ceramic capacitors (max load).

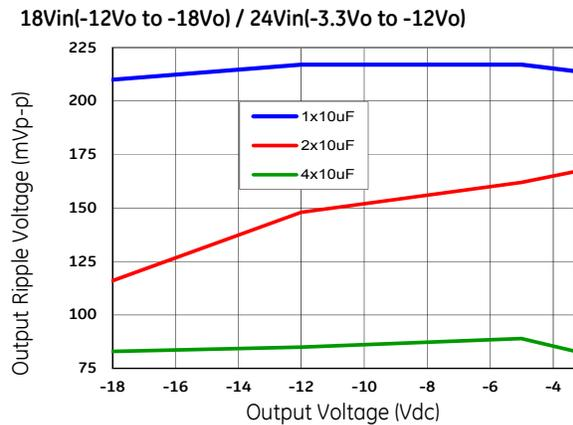

Figure 68. Output ripple with 1x10µF, 2x10µF or 4x10µF output ceramic capacitors (max load).

9-36V ProLynx™ 5A: Non-Isolated DC-DC Power Modules

9Vdc –36Vdc input; 3Vdc to 18Vdc output; 5A to 2.5A Scaled output current

9Vdc –24Vdc input; -3.3Vdc to -18Vdc output; 5A to 0.7A Scaled output current

Ordering Information

Please contact your GE Sales Representative for pricing, availability and optional features.

Table 8. Device Codes

Device Code	Input Voltage Range	Output Voltage	Output Current	On/Off Logic	Connector Type	Comcodes
APXW005A0X3-SRZ	9 – 36Vdc or 9 – 24Vdc in negative output application	3 – 18Vdc or -3.3 to -18Vdc in negative output application	5A – 2.5A or 5A – 0.7A in negative output application	Negative	SMT	CC109151916
APXW005A0X43-SRZ				Positive	SMT	CC109151908
APXW005A0X3-SRDZ				Negative	SMT	CC109168852

-Z refers to RoHS compliant parts

Table 9. Coding Scheme

Tlynx family	Sequencing feature.	Input voltage range	Output current	Output voltage	On/Off logic	Remote Sense	Options		ROHS Compliance
AP	X	W	005	X	4	3	-SR	-D	Z
	X = w/o Seq.	W = 9-36V	5A	X = programmable output	4 = positive No entry = negative	Available	S = Surface Mount R = Tape & Reel	D = 105°C operating ambient, 40G operating shock as per MIL Std 810F	Z = ROHS6

Contact Us

For more information, call us at

USA/Canada:

+1 888 546 3243, or +1 972 244 9288

Asia-Pacific:

+86.021.54279977*808

Europe, Middle-East and Africa:

+49.89.878067-280

India:

+91.80.28411633

www.ge.com/powerelectronics



Mouser Electronics

Authorized Distributor

Click to View Pricing, Inventory, Delivery & Lifecycle Information:

[GE \(General Electric\):](#)

[APXW005A0X3-SRDZ](#)