

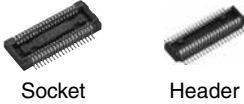

• Without soldering terminal

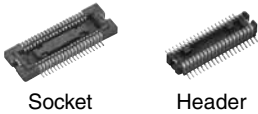

• With soldering terminal



Compliance with RoHS Directive

### FEATURES

- 0.4 mm pitch and support for mated heights of up to 1.5 mm, 2.0 mm, 2.5 mm, 3.0 mm, 3.5 mm, and 4.0 mm.
- Strong resistance to adverse environments! Utilizes **TOUGH CONTACT** construction for high contact reliability. (See Page 6 for details of the structure)
- It is constructed with impact dispersion keys inside the body to disperse shocks when dropped.

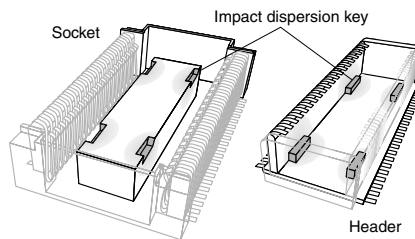

A high level of shock resistance is ensured by dispersing impact over the four locations where the socket indentations and header protrusions are mated together.

Note: The following numbers of contacts are not supported due to suction surface factors.

- Without soldering terminal: 18 contacts or less
- With soldering terminal: 22 contacts or less

#### 4. Construction makes designing devices easier.

1) The lower connector bottom surface construction prevents contact and shorts between the PCB and metal terminals. This enables freedom in pattern wiring, helping to make PCB's smaller.

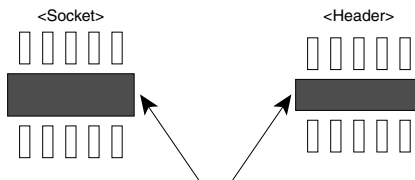

Connector bottom: Create any thru-hole and pattern wiring.

2) Guides are provided to take up any position shift and facilitate insertion.

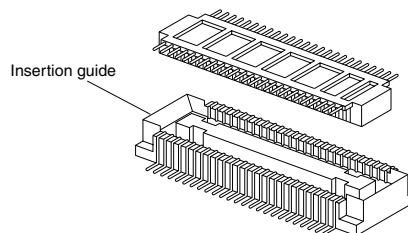

3) The connector has a simple lock mechanism. Superior mated operation with click feel to indicate that mated is complete.

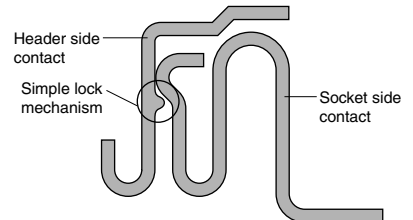

5. Design makes efficient mounting. Features a terminal flatness of 0.08 mm, construction resistant to creeping flux, and design that facilitates visual inspection of the soldered part.

6. Connectors for inspection available. Connectors for inspection are available that are ideal for modular unit inspection and inspection in device assembly processes.

### APPLICATIONS

Compact portable devices "Cellular phones, DVC, Digital cameras, etc"

#### Ideal for Board-to-FPC connections

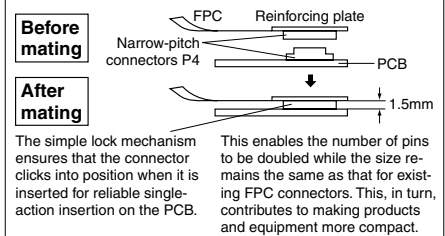

## ORDERING INFORMATION

AXK         **G**

7: Narrow Pitch Connector P4 (0.4 mm pitch) Socket

8: Narrow Pitch Connector P4 (0.4 mm pitch) Header

Number of contacts (2 digits)

Mated height

<Socket>

1: For mated height 1.5 mm

2: For mated height 2.0 mm

3: For mated height 2.5 mm and 3.0 mm

4: For mated height 3.5 mm

5: For mated height 4.0 mm

<Header>

1: For mated height 1.5 mm, 2.0 mm and 2.5 mm

2: For mated height 3.0 mm, 3.5 mm and 4.0 mm

Functions

2: With soldering terminal, without positioning bosses

4: Without soldering terminal, without positioning bosses

Surface treatment (Contact portion / Terminal portion)

<Socket>

7: Ni plating on base, Au plating on surface (for Ni barrier available)

<Header>

5: Ni plating on base, Au plating on surface

Other specifications

<Header>

W: V notch and post edge horseshoe bend type product

Packing

G: 3,000 pieces embossed tape and plastic reel × 2\*

Notes: 1. Only a socket of mated height 3.5 mm and 4.0 mm: 2,000 pieces embossed tape and plastic reel × 2.

2. Please note that the models with a soldering terminal (8th digit of part number is "2") and those without a soldering terminal (8th digit of part number is "4") are shaped differently and are not compatible.

# AXK7, 8

## PRODUCT TYPES

### 1. Without soldering terminal

| Mated height | Number of contacts | Part number          |                      | Packing                                      |  |             |              |              |
|--------------|--------------------|----------------------|----------------------|--|--|-------------|--------------|--------------|
|              |                    | Socket               | Header               | Inner carton                                 | Outer carton                                 |             |              |              |
|              |                    | <b>TOUGH CONTACT</b> | <b>TOUGH CONTACT</b> |  |  |             |              |              |
| 1.5 mm       | 14                 | AXK714147G           | AXK814145WG          | 3,000 pieces                                 | 6,000 pieces                                 |             |              |              |
|              | 16                 | AXK716147G           | AXK816145WG          |  |  |             |              |              |
|              | 20                 | AXK720147G           | AXK820145WG          |  |  |             |              |              |
|              | 22                 | AXK722147G           | AXK822145WG          |  |  |             |              |              |
|              | 24                 | AXK724147G           | AXK824145WG          |  |  |             |              |              |
|              | 26                 | AXK726147G           | AXK826145WG          |  |  |             |              |              |
|              | 28                 | AXK728147G           | AXK828145WG          |  |  |             |              |              |
|              | 30                 | AXK730147G           | AXK830145WG          |  |  |             |              |              |
|              | 34                 | AXK734147G           | AXK834145WG          |  |  |             |              |              |
|              | 36                 | AXK736147G           | AXK836145WG          |  |  |             |              |              |
|              | 40                 | AXK740147G           | AXK840145WG          |  |  |             |              |              |
|              | 42                 | AXK742147G           | AXK842145WG          |  |  |             |              |              |
|              | 44                 | AXK744147G           | AXK844145WG          |  |  |             |              |              |
|              | 50                 | AXK750147G           | AXK850145WG          |  |  |             |              |              |
|              | 54                 | AXK754147G           | AXK854145WG          |  |  |             |              |              |
|              | 60                 | AXK760147G           | AXK860145WG          |  |  |             |              |              |
|              | 2.0 mm             | 14                   | AXK714247G           |  |  | AXK814145WG | 3,000 pieces | 6,000 pieces |
|              |                    | 20                   | AXK720247G           |  |  | AXK820145WG |              |              |
| 24           |                    | AXK724247G           | AXK824145WG          |  |  |             |              |              |
| 26           |                    | AXK726247G           | AXK826145WG          |  |  |             |              |              |
| 30           |                    | AXK730247G           | AXK830145WG          |  |  |             |              |              |
| 34           |                    | AXK734247G           | AXK834145WG          |  |  |             |              |              |
| 38           |                    | AXK738247G           | AXK838145WG          |  |  |             |              |              |
| 40           |                    | AXK740247G           | AXK840145WG          |  |  |             |              |              |
| 50           |                    | AXK750247G           | AXK850145WG          |  |  |             |              |              |
| 60           |                    | AXK760247G           | AXK860145WG          |  |  |             |              |              |
| 70           |                    | AXK770247G           | AXK870145WG          |  |  |             |              |              |
| 80           |                    | AXK780247G           | AXK880145WG          |  |  |             |              |              |
| 2.5 mm       | 14                 | AXK714347G           | AXK814145WG          | 3,000 pieces                                 | 6,000 pieces                                 |             |              |              |
|              | 20                 | AXK720347G           | AXK820145WG          |  |  |             |              |              |
|              | 24                 | AXK724347G           | AXK824145WG          |  |  |             |              |              |
|              | 30                 | AXK730347G           | AXK830145WG          |  |  |             |              |              |
|              | 34                 | AXK734347G           | AXK834145WG          |  |  |             |              |              |
|              | 40                 | AXK740347G           | AXK840145WG          |  |  |             |              |              |
|              | 44                 | AXK744347G           | AXK844145WG          |  |  |             |              |              |
|              | 50                 | AXK750347G           | AXK850145WG          |  |  |             |              |              |
|              | 60                 | AXK760347G           | AXK860145WG          |  |  |             |              |              |
|              | 70                 | AXK770347G           | AXK870145WG          |  |  |             |              |              |
|              | 80                 | AXK780347G           | AXK880145WG          |  |  |             |              |              |
|              | 90                 | AXK790347G           | AXK890145WG          |  |  |             |              |              |
| 3.0 mm       | 100                | AXK700347G           | AXK800145WG          | 3,000 pieces                                 | 6,000 pieces                                 |             |              |              |
|              | 24                 | AXK724347G           | AXK824245WG          |  |  |             |              |              |
|              | 30                 | AXK730347G           | AXK830245WG          |  |  |             |              |              |
|              | 50                 | AXK750347G           | AXK850245WG          |  |  |             |              |              |
| 3.5 mm       | 80                 | AXK780347G           | AXK880245WG          | Socket: 2,000 pieces<br>Header: 3,000 pieces | Socket: 4,000 pieces<br>Header: 6,000 pieces |             |              |              |
|              | 30                 | AXK730447G           | AXK830245WG          |  |  |             |              |              |
| 4.0 mm       | 40                 | AXK740447G           | AXK840245WG          | Socket: 2,000 pieces<br>Header: 3,000 pieces | Socket: 4,000 pieces<br>Header: 6,000 pieces |             |              |              |
|              | 24                 | AXK724547G           | AXK824245WG          |  |  |             |              |              |

Notes: 1. Regarding ordering units; During production: Please make orders in 1-reel units.

Samples for mounting confirmation: Available in units of 50 pieces. Please consult us. (See "Regarding sample orders to confirm proper mounting" on page 19.)

Samples: Small lot orders are possible.

- The above part numbers are for connectors without positioning bosses, which are standard. When ordering connectors with positioning bosses, please contact our sales office.
- "W" indicates a product with V notch and post edge horseshoe bend. ("Post edge horseshoe bend" refers to a construction that makes it difficult for the header post edge to deform when the connector is inserted and removed at an angle.)
- Previous V notch types ("Y" in 10 th place of the header part number) and the current V notch + post edge horseshoe bend types ("W" in the 10 th place of the header part number) are compatible for mating.
- Connectors of different mated height (3.0 mm, 3.5 mm and 4.0 mm) and different number of contacts are available on-demand production only. Please contact us for more details.

2. With soldering terminal  **TOUGH CONTACT**

| Mated height | Number of contacts | Part number          |                      | Packing                                      |  |
|--------------|--------------------|----------------------|----------------------|--|--|
|              |                    | Socket               | Header               | Inner carton                                 | Outer carton                                 |
|              |                    | <i>TOUGH CONTACT</i> | <i>TOUGH CONTACT</i> |  |  |
| 1.5 mm       | 10                 | AXK710127G           | AXK810125WG          | 3,000 pieces                                 | 6,000 pieces                                 |
|              | 12                 | AXK712127G           | AXK812125WG          |  |  |
|              | 20                 | AXK720127G           | AXK820125WG          |  |  |
|              | 22                 | AXK722127G           | AXK822125WG          |  |  |
|              | 24                 | AXK724127G           | AXK824125WG          |  |  |
|              | 28                 | AXK728127G           | AXK828125WG          |  |  |
|              | 30                 | AXK730127G           | AXK830125WG          |  |  |
|              | 34                 | AXK734127G           | AXK834125WG          |  |  |
|              | 36                 | AXK736127G           | AXK836125WG          |  |  |
|              | 40                 | AXK740127G           | AXK840125WG          |  |  |
|              | 44                 | AXK744127G           | AXK844125WG          |  |  |
|              | 46                 | AXK746127G           | AXK846125WG          |  |  |
|              | 50                 | AXK750127G           | AXK850125WG          |  |  |
|              | 60                 | AXK760127G           | AXK860125WG          |  |  |
| 80           | AXK780127G         | AXK880125WG          |                      |  |  |
| 90           | AXK790127G         | AXK890125WG          |                      |  |  |
| 100          | AXK700127G         | AXK800125WG          |                      |  |  |
| 2.0 mm       | 20                 | AXK720227G           | AXK820125WG          |  |  |
|              | 24                 | AXK724227G           | AXK824125WG          |  |  |
|              | 40                 | AXK740227G           | AXK840125WG          |  |  |
|              | 50                 | AXK750227G           | AXK850125WG          |  |  |
|              | 60                 | AXK760227G           | AXK860125WG          |  |  |
|              | 80                 | AXK780227G           | AXK880125WG          |  |  |
| 2.5 mm       | 12                 | AXK712327G           | AXK812125WG          |  |  |
|              | 20                 | AXK720327G           | AXK820125WG          |  |  |
|              | 28                 | AXK728327G           | AXK828125WG          |  |  |
|              | 32                 | AXK732327G           | AXK832125WG          |  |  |
|              | 40                 | AXK740327G           | AXK840125WG          |  |  |
|              | 50                 | AXK750327G           | AXK850125WG          |  |  |
|              | 60                 | AXK760327G           | AXK860125WG          |  |  |
|              | 80                 | AXK780327G           | AXK880125WG          |  |  |
| 90           | AXK790327G         | AXK890125WG          |                      |  |  |
| 3.0 mm       | 20                 | AXK720327G           | AXK820225WG          |  |  |
|              | 36                 | AXK736327G           | AXK836225WG          |  |  |
|              | 40                 | AXK740327G           | AXK840225WG          |  |  |
|              | 50                 | AXK750327G           | AXK850225WG          |  |  |
|              | 60                 | AXK760327G           | AXK860225WG          |  |  |
|              | 80                 | AXK780327G           | AXK880225WG          |  |  |
| 90           | AXK790327G         | AXK890225WG          |                      |  |  |
| 3.5 mm       | 20                 | AXK720427G           | AXK820225WG          | Socket: 2,000 pieces<br>Header: 3,000 pieces | Socket: 4,000 pieces<br>Header: 6,000 pieces |
|              | 30                 | AXK730427G           | AXK830225WG          |  |  |
|              | 40                 | AXK740427G           | AXK840225WG          |  |  |
|              | 50                 | AXK750427G           | AXK850225WG          |  |  |
|              | 60                 | AXK760427G           | AXK860225WG          |  |  |
|              | 70                 | AXK770427G           | AXK870225WG          |  |  |
|              | 80                 | AXK780427G           | AXK880225WG          |  |  |
| 4.0 mm       | 34                 | AXK734527G           | AXK834225WG          | Socket: 2,000 pieces<br>Header: 3,000 pieces | Socket: 4,000 pieces<br>Header: 6,000 pieces |
|              | 42                 | AXK742527G           | AXK842225WG          |  |  |
|              | 50                 | AXK750527G           | AXK850225WG          |  |  |
|              | 80                 | AXK780527G           | AXK880225WG          |  |  |

- Notes: 1. Regarding ordering units; During production: Please make orders in 1-reel units.  
 Samples for mounting confirmation: Available in units of 50 pieces. Please consult us. (See "Regarding sample orders to confirm proper mounting" on page 19.)  
 Samples: Small lot orders are possible.
- The above part numbers are for connectors without positioning bosses, which are standard. When ordering connectors with positioning bosses, please contact our sales office.
  - "W" indicates a product with V notch and post edge horseshoe bend. ("Post edge horseshoe bend" refers to a construction that makes it difficult for the header post edge to deform when the connector is inserted and removed at an angle.)
  - Previous V notch types ("Y" in 10 th place of the header part number) and the current V notch + post edge horseshoe bend types ("W" in the 10 th place of the header part number) are compatible for mating.
  - Different number of contacts are available on-demand production only. Please contact us for more details.

# AXK7, 8

## SPECIFICATIONS

### 1. Characteristics

|   | Item   | Specifications  | Conditions  |
|---|--|---|---|
| Electrical characteristics                            | Rated current  | 0.3A/contact (Max. 5 A at total contacts)   |   |
|   | Rated voltage  | 60V AC/DC   |   |
|   | Breakdown voltage                                    | 150V AC for 1 min.  | Detection current: 1mA  |
|   | Insulation resistance                                | Min. 1,000M $\Omega$ (initial)  | Using 250V DC megger (applied for 1 min.)   |
|   | Contact resistance                                   | Max. 70m $\Omega$   | Based on the contact resistance measurement method specified by JIS C 5402.   |
| Mechanical characteristics                            | Composite insertion force                            | Max. 0.981N {100gf}/contacts $\times$ contacts (initial)  |   |
|   | Composite removal force                              | Min. 0.0588N {6gf}/contacts $\times$ contacts (Mated height 1.5 mm, without removal and soldering terminal)<br>Min. 0.118N {12gf}/contacts $\times$ contacts (Mated height 1.5 mm, except without removal and soldering terminal) |   |
|   | Post holding force                                   | Min. 0.981N {100gf}/contacts  | Measuring the maximum force. As the contact is axially pull out.  |
| Environmental characteristics                         | Ambient temperature                                  | -55°C to +85°C  | No freezing at low temperatures   |
|   | Soldering heat resistance                            | Max. peak temperature of 260°C (on the surface of the PC board around the connector terminals)  | Infrared reflow soldering   |
|   |  | 300°C within 5 sec. 350°C within 3 sec.   | Soldering iron  |
|   | Thermal shock resistance (header and socket mated)   | 5 cycles, insulation resistance min. 100M $\Omega$ , contact resistance max. 70m $\Omega$   | Sequence<br>1. -55 $\pm$ 3°C, 30 minutes<br>2. ~, Max. 5 minutes<br>3. 85 $\pm$ 3°C, 30 minutes<br>4. ~, Max. 5 minutes |
|   | Humidity resistance (header and socket mated)        | 120 hours, insulation resistance min. 100M $\Omega$ , contact resistance max. 70m $\Omega$  | Bath temperature 40 $\pm$ 2°C, humidity 90 to 95% R.H.  |
|   | Saltwater spray resistance (header and socket mated) | 24 hours, insulation resistance min. 100M $\Omega$ , contact resistance max. 70m $\Omega$   | Bath temperature 35 $\pm$ 2°C, saltwater concentration 5 $\pm$ 1%   |
| H <sub>2</sub> S resistance (header and socket mated) | 48 hours, contact resistance max. 70m $\Omega$       | Bath temperature 40 $\pm$ 2°C, gas concentration 3 $\pm$ 1 ppm, humidity 75 to 80% R.H.   |   |
| Lifetime characteristics                              | Insertion and removal life                           | 50 times  | Repeated insertion and removal speed of max. 200 times/hours  |
| Unit weight   |  | Mated height 1.5mm, 20 contacts;<br>Socket: 0.04g Header: 0.02g   |   |

### 2. Material and surface treatment

| Part name                  | Material            | Surface treatment   |
|----------------------------|---------------------|---|
| Molded portion             | LCP resin (UL94V-0) | —   |
| Contact and Post           | Copper alloy        | Contact portion: Ni plating on base, Au plating on surface<br>Terminal portion: Ni plating on base, Au plating on surface (Except for thick of terminal)<br>However, upper terminal of Ni barrier production: Exposed over Ni<br>The area adjacent to the terminal of the sockets on models with Ni barrier is exposed to Ni on base. |
| Soldering terminal portion | Copper alloy        | Ni plating on base, Sn plating on surface (Except for front terminal)   |

## DIMENSIONS (Unit: mm)

The CAD data of the products with a **CAD Data** mark can be downloaded from: <http://panasonic-electric-works.net/ac>

### 1. Without Soldering Terminal

Socket (Mated height: 1.5 mm, 2.0 mm, 2.5 mm, 3.0 mm, 3.5 mm and 4.0 mm)

**CAD Data**

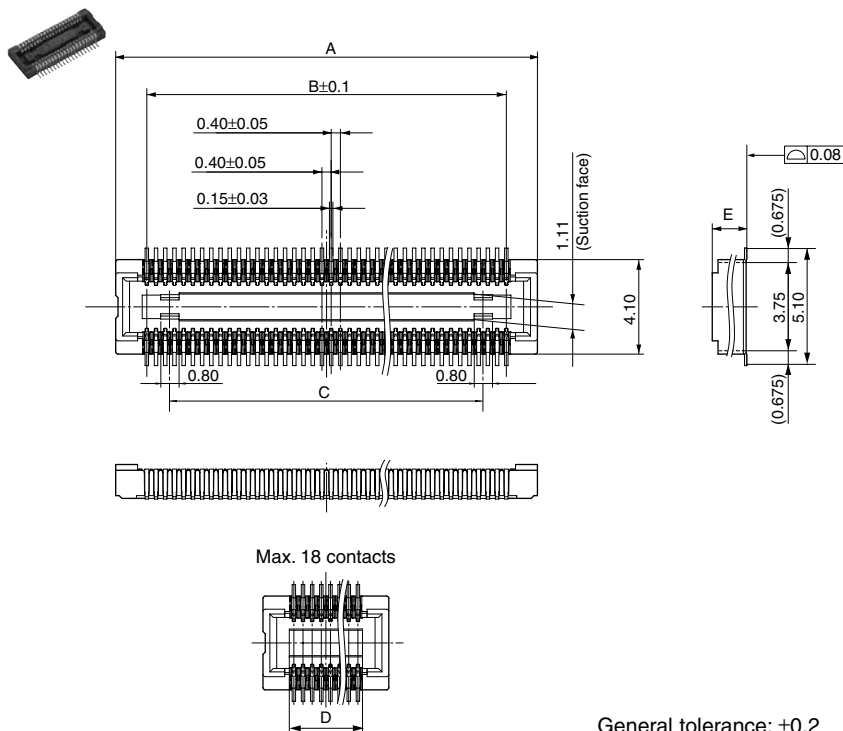

Dimension table (mm)

| Number of contacts/<br>dimension | A    | B    | C    | D   |
|----------------------------------|------|------|------|-----|
| 14                               | 5.1  | 2.4  | —    | 2.8 |
| 16                               | 5.5  | 2.8  | —    | 3.2 |
| 20                               | 6.3  | 3.6  | 1.6  | —   |
| 22                               | 6.7  | 4.0  | 2.0  | —   |
| 24                               | 7.1  | 4.4  | 2.4  | —   |
| 26                               | 7.5  | 4.8  | 2.8  | —   |
| 28                               | 7.9  | 5.2  | 3.2  | —   |
| 30                               | 8.3  | 5.6  | 3.6  | —   |
| 34                               | 9.1  | 6.4  | 4.4  | —   |
| 36                               | 9.5  | 6.8  | 4.8  | —   |
| 38                               | 9.9  | 7.2  | 5.2  | —   |
| 40                               | 10.3 | 7.6  | 5.6  | —   |
| 42                               | 10.7 | 8.0  | 6.0  | —   |
| 44                               | 11.1 | 8.4  | 6.4  | —   |
| 50                               | 12.3 | 9.6  | 7.6  | —   |
| 54                               | 13.1 | 10.4 | 8.4  | —   |
| 60                               | 14.3 | 11.6 | 9.6  | —   |
| 64                               | 15.1 | 12.4 | 10.4 | —   |
| 70                               | 16.3 | 13.6 | 11.6 | —   |
| 80                               | 18.3 | 15.6 | 13.6 | —   |
| 90                               | 20.3 | 17.6 | 15.6 | —   |
| 100                              | 22.3 | 19.6 | 17.6 | —   |

| Mated height/dimension | E    |
|------------------------|------|
| 1.5mm                  | 1.50 |
| 2.0mm                  | 1.92 |
| 2.5mm, 3.0mm           | 2.42 |
| 3.5mm                  | 2.92 |
| 4.0mm                  | 3.42 |

Header (Mated height: 1.5 mm, 2.0 mm, 2.5 mm, 3.0 mm, 3.5 mm and 4.0 mm)

**CAD Data**

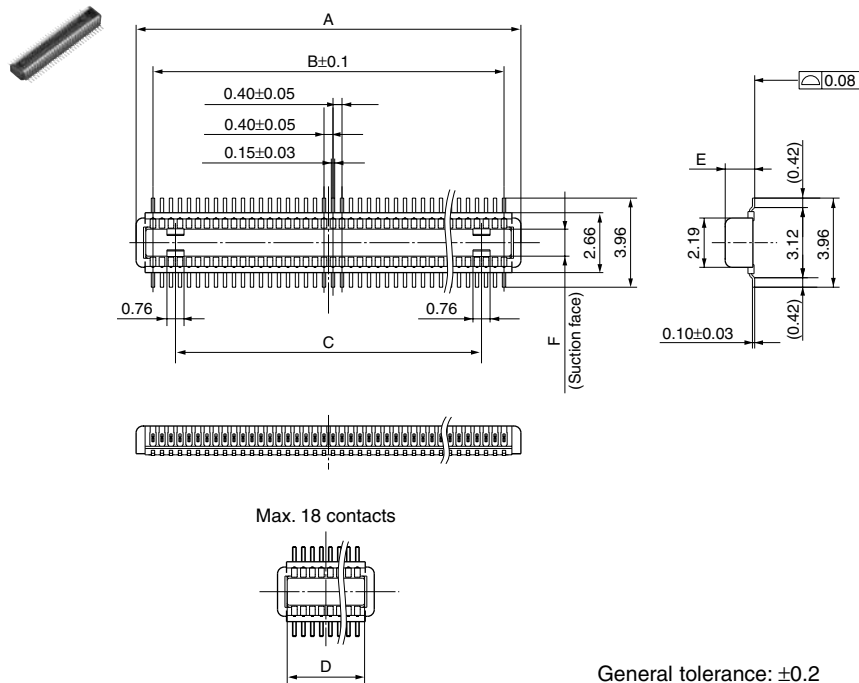

Dimension table (mm)

| Number of contacts/<br>dimension | A    | B    | C    | D    |
|----------------------------------|------|------|------|------|
| 14                               | 3.9  | 2.4  | —    | 3.04 |
| 16                               | 4.3  | 2.8  | —    | 3.44 |
| 20                               | 5.1  | 3.6  | 1.6  | —    |
| 22                               | 5.5  | 4.0  | 2.0  | —    |
| 24                               | 5.9  | 4.4  | 2.4  | —    |
| 26                               | 6.3  | 4.8  | 2.8  | —    |
| 28                               | 6.7  | 5.2  | 3.2  | —    |
| 30                               | 7.1  | 5.6  | 3.6  | —    |
| 34                               | 7.9  | 6.4  | 4.4  | —    |
| 36                               | 8.3  | 6.8  | 4.8  | —    |
| 38                               | 8.7  | 7.2  | 5.2  | —    |
| 40                               | 9.1  | 7.6  | 5.6  | —    |
| 42                               | 9.5  | 8.0  | 6.0  | —    |
| 44                               | 9.9  | 8.4  | 6.4  | —    |
| 50                               | 11.1 | 9.6  | 7.6  | —    |
| 54                               | 11.9 | 10.4 | 8.4  | —    |
| 60                               | 13.1 | 11.6 | 9.6  | —    |
| 64                               | 13.9 | 12.4 | 10.4 | —    |
| 70                               | 15.1 | 13.6 | 11.6 | —    |
| 80                               | 17.1 | 15.6 | 13.6 | —    |
| 90                               | 19.1 | 17.6 | 15.6 | —    |
| 100                              | 21.1 | 19.6 | 17.6 | —    |

| Mated height/dimension | E    | F    |
|------------------------|------|------|
| 1.5mm, 2.0mm, 2.5mm    | 1.31 | 1.20 |
| 3.0mm, 3.5mm, 4.0mm    | 2.26 | 1.26 |

Socket and Header are mated

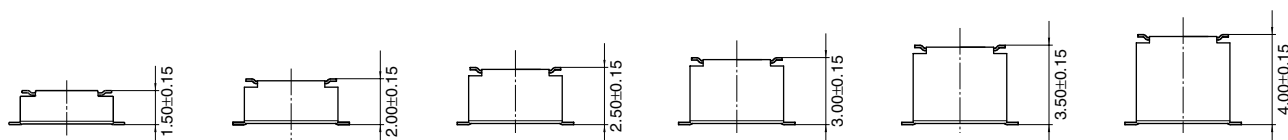

# AXK7, 8

## 2. With Soldering Terminal

Socket (Mated height: 1.5mm, 2.0mm, 2.5mm, 3.0mm, 3.5mm and 4.0mm)

### CAD Data

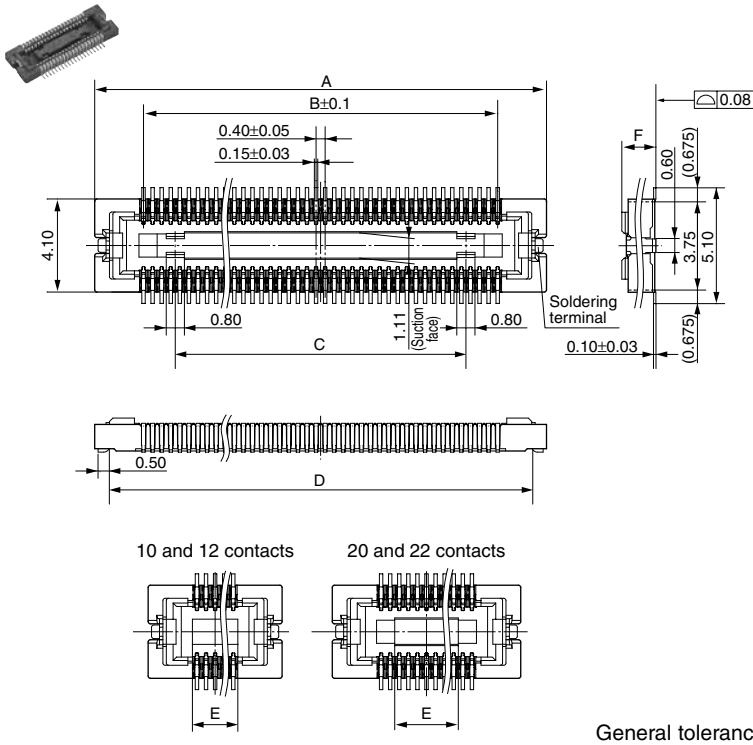

Dimension table (mm)

| Number of contacts/<br>dimension | A     | B     | C     | D     | E    |
|----------------------------------|-------|-------|-------|-------|------|
| 10                               | 5.90  | 1.60  | —     | 4.60  | 2.00 |
| 12                               | 6.30  | 2.00  | —     | 5.00  | 2.40 |
| 20                               | 7.90  | 3.60  | —     | 6.60  | 2.40 |
| 22                               | 8.30  | 4.00  | —     | 7.00  | 2.80 |
| 24                               | 8.70  | 4.40  | 1.60  | 7.40  | —    |
| 28                               | 9.50  | 5.20  | 2.40  | 8.20  | —    |
| 30                               | 9.90  | 5.60  | 2.80  | 8.60  | —    |
| 32                               | 10.30 | 6.00  | 3.20  | 9.00  | —    |
| 34                               | 10.70 | 6.40  | 3.60  | 9.40  | —    |
| 36                               | 11.10 | 6.80  | 4.00  | 9.40  | —    |
| 40                               | 11.90 | 7.60  | 4.80  | 10.60 | —    |
| 42                               | 12.30 | 8.00  | 5.20  | 11.00 | —    |
| 44                               | 12.70 | 8.40  | 5.60  | 11.40 | —    |
| 46                               | 13.10 | 8.80  | 6.00  | 11.80 | —    |
| 50                               | 13.90 | 9.60  | 6.80  | 12.60 | —    |
| 60                               | 15.90 | 11.60 | 8.80  | 14.60 | —    |
| 70                               | 17.90 | 13.60 | 10.80 | 16.60 | —    |
| 80                               | 19.90 | 15.60 | 12.80 | 18.60 | —    |
| 90                               | 21.90 | 17.60 | 14.80 | 20.60 | —    |
| 100                              | 23.90 | 19.60 | 16.80 | 22.60 | —    |

| Mated height/dimension | F    |
|------------------------|------|
| 1.5mm                  | 1.50 |
| 2.0mm                  | 1.92 |
| 2.5mm, 3.0mm           | 2.42 |
| 3.5mm                  | 2.92 |
| 4.0mm                  | 3.42 |

Header (Mated height: 1.5mm, 2.0mm, 2.5mm, 3.0mm, 3.5mm and 4.0mm)

### CAD Data

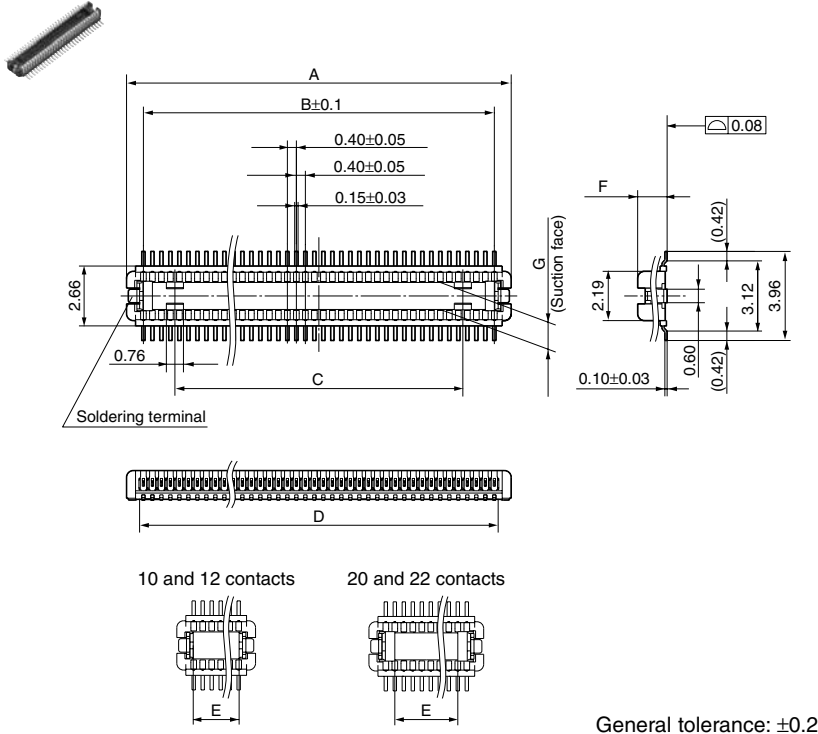

Dimension table (mm)

| Number of contacts/<br>dimension | A     | B     | C     | D     | E    |
|----------------------------------|-------|-------|-------|-------|------|
| 10                               | 3.10  | 1.60  | —     | 1.94  | 1.64 |
| 12                               | 3.50  | 2.00  | —     | 2.34  | 2.04 |
| 20                               | 5.10  | 3.60  | —     | 3.94  | 2.80 |
| 22                               | 5.50  | 4.00  | —     | 4.34  | 3.20 |
| 24                               | 5.90  | 4.40  | 1.60  | 4.74  | —    |
| 28                               | 6.70  | 5.20  | 2.40  | 5.54  | —    |
| 30                               | 7.10  | 5.60  | 2.80  | 5.94  | —    |
| 32                               | 7.50  | 6.00  | 3.20  | 6.34  | —    |
| 34                               | 7.90  | 6.40  | 3.60  | 6.74  | —    |
| 36                               | 8.30  | 6.80  | 4.00  | 7.14  | —    |
| 40                               | 9.10  | 7.60  | 4.80  | 7.94  | —    |
| 42                               | 9.50  | 8.00  | 5.20  | 8.34  | —    |
| 44                               | 9.90  | 8.40  | 5.60  | 8.74  | —    |
| 46                               | 10.30 | 8.80  | 6.00  | 9.14  | —    |
| 50                               | 11.10 | 9.60  | 6.80  | 9.94  | —    |
| 60                               | 13.10 | 11.60 | 8.80  | 11.94 | —    |
| 70                               | 15.10 | 13.60 | 10.80 | 13.94 | —    |
| 80                               | 17.10 | 15.60 | 12.80 | 15.94 | —    |
| 90                               | 19.10 | 17.60 | 14.80 | 17.94 | —    |
| 100                              | 21.10 | 19.60 | 16.80 | 19.94 | —    |

| Mated height/dimension | F    | G    |
|------------------------|------|------|
| 1.5mm, 2.0mm, 2.5mm    | 1.31 | 1.20 |
| 3.0mm, 3.5mm, 4.0mm    | 2.26 | 1.26 |

Socket and Header are mated.

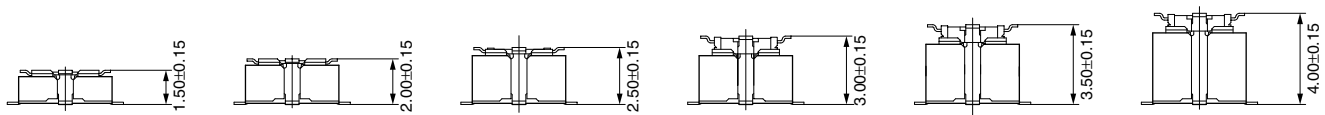

# EMBOSSED TAPE DIMENSIONS (unit: mm, Common for respective contact type, socket and header)

• Tape dimensions (Conforming to JIS C 0806-1990.

• Plastic reel dimensions (Conforming to EIAJ ET-7200B)

However, some tapes have mounting hole pitches that do not comply with the standard.)

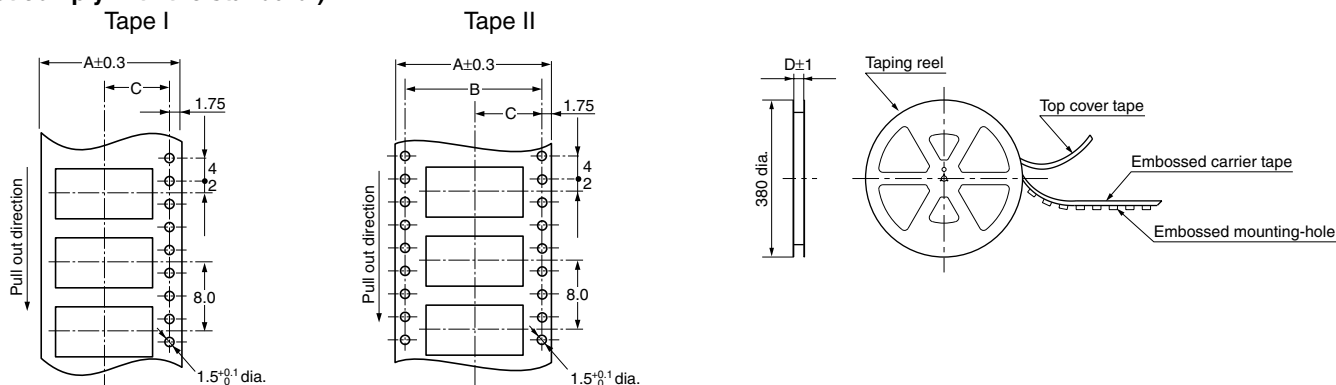

## Dimension table (mm)

### 1. Without Soldering Terminal

| Mated height   | Number of contacts | Type of taping | A    | B    | C    | D    | Quantity per reel |
|--|--------------------|----------------|------|------|------|------|-------------------|
| Common for socket and header:<br>1.5 mm, 2.0 mm and 2.5 mm | Max. 18            | Tape I         | 16.0 | —    | 7.5  | 17.4 | 3,000             |
|  | 20 to 70           | Tape I         | 24.0 | —    | 11.5 | 25.4 | 3,000             |
|  | 80 to 100          | Tape II        | 32.0 | 28.4 | 14.2 | 33.4 | 3,000             |

### 2. With Soldering Terminal

| Mated height  | Number of contacts |           | Type of taping | A    | B    | C    | D    | Quantity per reel |
|---|--------------------|-----------|----------------|------|------|------|------|-------------------|
|   | Socket             | Header    |                |      |      |      |      |                   |
| Common for socket and header:<br>1.5 mm, 2.0 mm, 2.5 mm, and 3.0 mm<br>Header: 3.5mm and 4.0 mm | Max. 18            | Max. 18   | Tape I         | 16.0 | —    | 7.5  | 17.4 | 3,000             |
|   | 20 to 60           | 20 to 70  | Tape I         | 24.0 | —    | 11.5 | 25.4 | 3,000             |
|   | 70 to 90           | 80 to 100 | Tape II        | 32.0 | 28.4 | 14.2 | 33.4 | 3,000             |
|   | 100                | —         | Tape II        | 44.0 | 40.4 | 20.2 | 45.4 | 3,000             |
| Socket: 3.5mm and 4.0 mm  | Max. 18            |           | Tape I         | 16.0 | —    | 7.5  | 17.4 | 2,000             |
|   | 20 to 60           |           | Tape I         | 24.0 | —    | 11.5 | 25.4 | 2,000             |
|   | 70 to 90           |           | Tape II        | 32.0 | 28.4 | 14.2 | 33.4 | 2,000             |
|   | 100                |           | Tape II        | 44.0 | 40.4 | 20.2 | 45.4 | 2,000             |

### 3. Connector orientation with respect to direction of progress of embossed tape

#### 1) Without soldering terminal

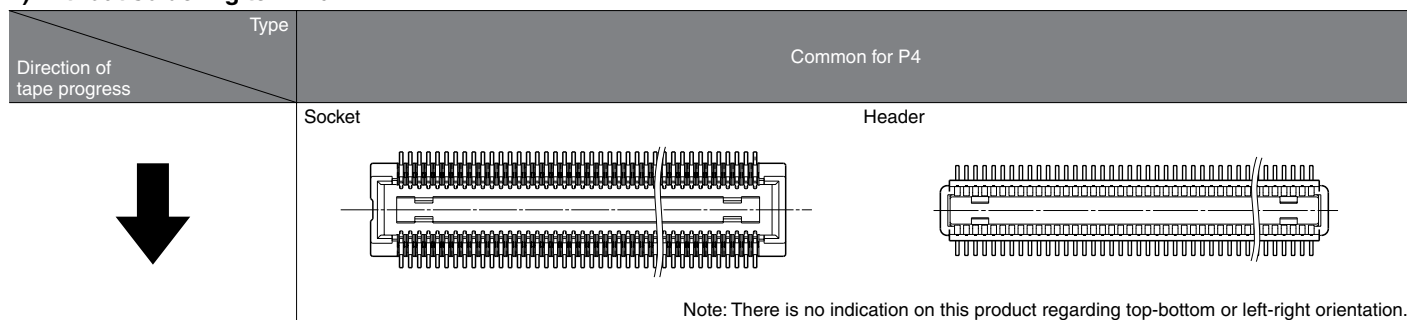

#### 2) With soldering terminal

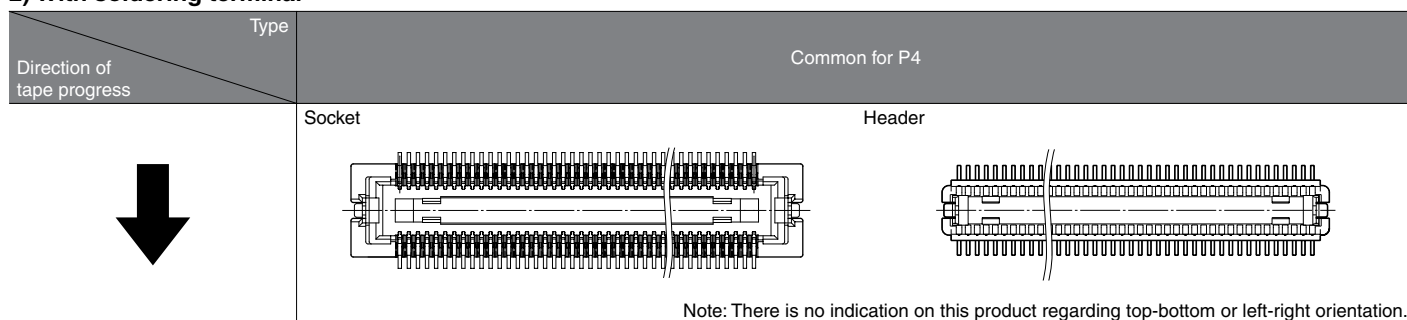





Socket



Header

**Compliance with RoHS Directive**

## TABLE OF PRODUCT TYPES

☆: Available for sale

| Product name | P4 for inspection without soldering terminal | P4 for inspection with soldering terminal |
|--------------|--|---|
| 10           |  | ☆   |
| 12           |  | ☆   |
| 14           | ☆  |   |
| 16           | ☆  |   |
| 20           | ☆  | ☆   |
| 22           | ☆  | ☆   |
| 24           | ☆  | ☆   |
| 26           | ☆  |   |
| 28           | ☆  | ☆   |
| 30           | ☆  | ☆   |
| 34           | ☆  | ☆   |
| 36           | ☆  |   |
| 40           | ☆  | ☆   |
| 42           | ☆  |   |
| 44           | ☆  | ☆   |
| 46           |  | ☆   |
| 50           | ☆  | ☆   |
| 54           | ☆  |   |
| 60           | ☆  | ☆   |
| 70           | ☆  |   |
| 80           | ☆  | ☆   |
| 90           | ☆  | ☆   |
| 100          | ☆  | ☆   |

Number of contacts

Notes:

1. You can use with each mated height in common.
2. Please inquire about numbers of contacts other than those given above.
3. Please inquire with us regarding delivery times.
4. Please keep the minimum unit for ordering no less than 50 pieces per lot.
5. Please inquire for further information.

## FEATURES

### 1. 3,000 insertion and removals (when as recommended)

From the 50 insertion and removals of standard type, up to 3,000 insertion and removals (with recommended insertion and removal) are possible for use in inspection.

Ideal for inspection of module units and inspection during the device assembly process

### 2. Same external dimensions and foot pattern as standard type.

Since shape is the same as standard type, inspection is possible without interfering with devices in the vicinity of standard connectors.

### 3. Improved mating

Insertion and removal have become easier due to a reduction in the mating retention force required by the simple locking structure and also in the amount of force needed for insertion and removal. (We cannot warrant anything regarding mating retention.)

## PRODUCT TYPES

| Specifications |                            |                            | Part No.   | Specifications |                            |                            | Part No.    |
|----------------|----------------------------|----------------------------|------------|----------------|----------------------------|----------------------------|-------------|
| Socket         | With soldering terminal    | Without positioning bosses | AXK7E**26G | Header         | With soldering terminal    | Without positioning bosses | AXK8E**26WG |
|                | Without soldering terminal | Without positioning bosses | AXK7E**46G |                | Without soldering terminal | Without positioning bosses | AXK8E**46WG |

Notes: 1. When placing an order, substitute the "\*" (asterisk) in the above part number with the number of contacts for the required connector.

2. The above part numbers are for connectors without positioning bosses, which are standard. When ordering connectors with positioning bosses, please contact our sales office.

## NOTES

1. As shown below, excess force during insertion may result in damage to the connector or removal of the solder. Please be careful. Also, to prevent connector damage please confirm the correct position before mating connectors.

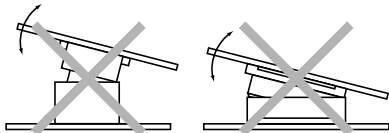

2. Keep the PC board warp no more than 0.03 mm in relation to the overall length of the connector.

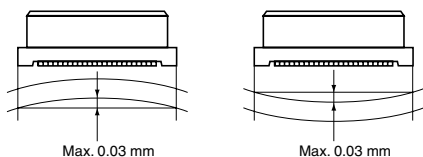

### 3. PC Boards and Recommended Metal Mask Patterns

Connectors are mounted with high density, with a pitch interval of 0.4 to 0.5 mm.

In order to reduce solder bridge and other issues make sure the proper levels of solder are used.

The figures to the right are recommended metal mask patterns.

Please use them as a reference.

1) Without soldering terminal

Socket

Recommended PC board pattern (TOP VIEW)

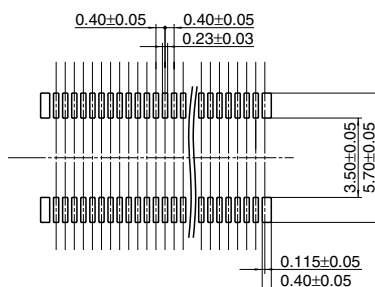

Recommended metal mask pattern

Metal mask thickness: Here, 150 μm  
(Opening area ratio: 40 %)

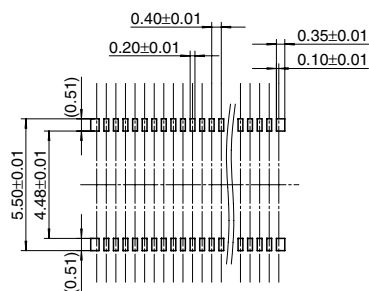

Recommended metal mask pattern

Metal mask thickness: Here, 120 μm  
(Opening area ratio: 50 %)

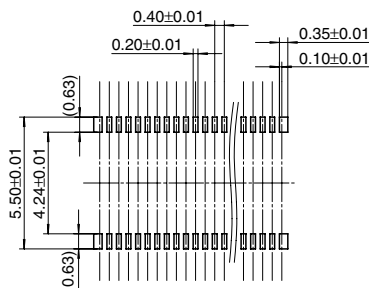

Header

Recommended PC board pattern (TOP VIEW)

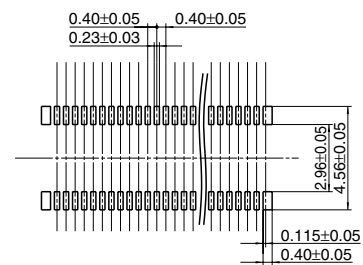

Recommended metal mask pattern

Metal mask thickness: Here, 150 μm  
(Opening area ratio: 32 %)

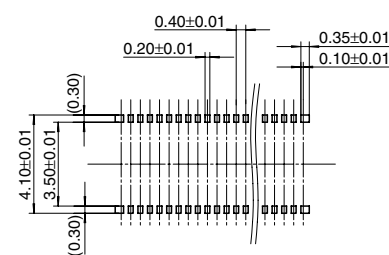

Recommended metal mask pattern

Metal mask thickness: Here, 120 μm  
(Opening area ratio: 40 %)

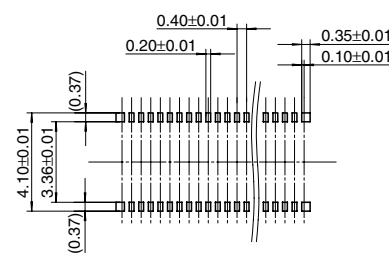

# AXK7, 8

## 2) With soldering terminal

### Socket

Recommended PC board pattern (TOP VIEW)

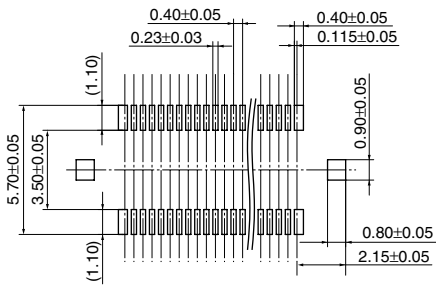

### Recommended metal mask pattern

Metal mask thickness: Here, 150 μm  
(Terminal portion opening area ratio: 40 %)  
(Metal portion opening area ratio: 65 %)

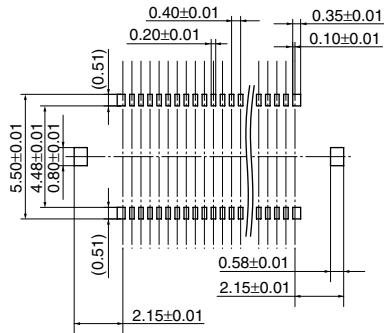

### Recommended metal mask pattern

Metal mask thickness: Here, 120 μm  
(Terminal portion opening area ratio: 50 %)  
(Metal portion opening area ratio: 80 %)

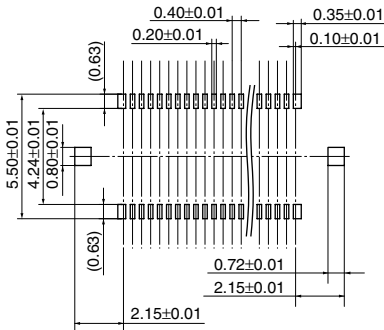

### Header

Recommended PC board pattern (TOP VIEW)

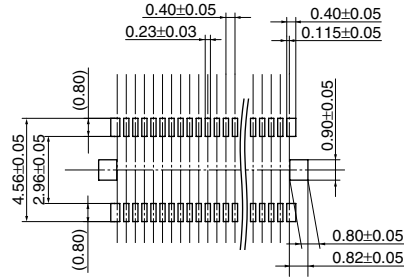

### Recommended metal mask pattern

Metal mask thickness: Here, 150 μm  
(Terminal portion opening area ratio: 32 %)  
(Metal portion opening area ratio: 65 %)

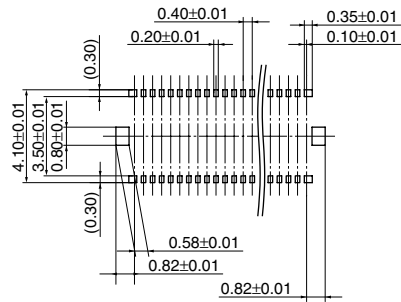

### Recommended metal mask pattern

Metal mask thickness: Here, 120 μm  
(Terminal portion opening area ratio: 40 %)  
(Metal portion opening area ratio: 80 %)

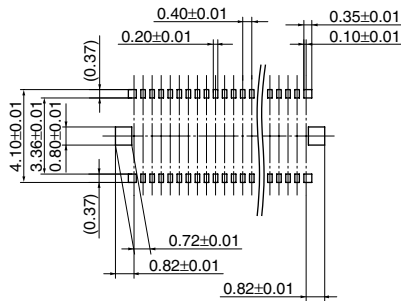

**For other details, please verify with the product specification sheets.**

# Mouser Electronics

Authorized Distributor

Click to View Pricing, Inventory, Delivery & Lifecycle Information:

## Panasonic:

[AXK724547G](#) [AXK726247G](#) [AXK730427G](#) [AXK730447G](#) [AXK760247G](#) [AXK830125WG](#) [AXK830225WG](#)  
[AXK700127G](#) [AXK710127G](#) [AXK722127G](#) [AXK726137G](#) [AXK726147G](#) [AXK740127G](#) [AXK750327G](#) [AXK760327G](#)  
[AXK7E8016G](#) [AXK800125WG](#) [AXK810125WG](#) [AXK820125WG](#) [AXK822125WG](#) [AXK826135WG](#) [AXK826145WG](#)  
[AXK840125WG](#) [AXK850225WG](#) [AXK860225WG](#) [AXK8E8016WG](#) [AXK700117G](#) [AXK700137G](#) [AXK700147G](#)  
[AXK700237G](#) [AXK700247G](#) [AXK700337G](#) [AXK700347G](#) [AXK710117G](#) [AXK714137G](#) [AXK714147G](#) [AXK714237G](#)  
[AXK714247G](#) [AXK714337G](#) [AXK714347G](#) [AXK716137G](#) [AXK716147G](#) [AXK720117G](#) [AXK720137G](#)  
[AXK720147G](#) [AXK720237G](#) [AXK720247G](#) [AXK720317G](#) [AXK720337G](#) [AXK720347G](#) [AXK720417G](#) [AXK722117G](#)  
[AXK722137G](#) [AXK722147G](#) [AXK724137G](#) [AXK724147G](#) [AXK724217G](#) [AXK724237G](#) [AXK724247G](#)  
[AXK724337G](#) [AXK724347G](#) [AXK728117G](#) [AXK728137G](#) [AXK728147G](#) [AXK730117G](#) [AXK730137G](#) [AXK730147G](#)  
[AXK730237G](#) [AXK730247G](#) [AXK730337G](#) [AXK730347G](#) [AXK732317G](#) [AXK734117G](#) [AXK734137G](#)  
[AXK734147G](#) [AXK734237G](#) [AXK734247G](#) [AXK734517G](#) [AXK734527G](#) [AXK736137G](#) [AXK736147G](#) [AXK740117G](#)  
[AXK740137G](#) [AXK740147G](#) [AXK740237G](#) [AXK740247G](#) [AXK740317G](#) [AXK740337G](#) [AXK740347G](#)  
[AXK744117G](#) [AXK744137G](#) [AXK744147G](#) [AXK744337G](#) [AXK744347G](#) [AXK746117G](#) [AXK750117G](#) [AXK750137G](#)  
[AXK750147G](#) [AXK750237G](#) [AXK750247G](#)