

ASD0400

Ultra Low Power Dual 20/40/65/80 MSPS, 10-bit Analog-to-Digital Converter

Features

- 10-bit resolution
- 20/40/65/80 MSPS maximum sampling rate
- Ultra-Low Power Dissipation: 24/43/65/78 mW
- 61.6 dB SNR at 8 MHz F_{IN}
- Internal reference circuitry
- 1.8 V core supply voltage
- 1.7 – 3.6 V I/O supply voltage
- Parallel CMOS output
- 64 pin QFN package
- Dual channel
- Pin compatible with ASD0500

Applications

- Medical Imaging
- Portable Test Equipment
- Digital Oscilloscopes
- IF Communication

Functional Block Diagram

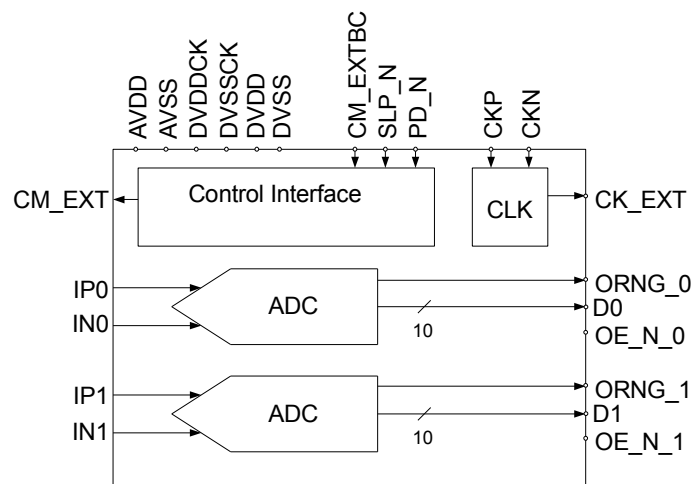

Figure 1: Functional Block Diagram



Table of Contents

Features.....	1	Absolute Maximum Ratings.....	9
Applications.....	1	Pin Configuration and Description.....	10
Description.....	1	Recommended Usage.....	11
Functional Block Diagram.....	1	Package Mechanical Data.....	15
Specifications.....	3	Product Information.....	16
Digital and timing Specifications.....	8	Ordering information.....	16
Timing Diagram.....	9	Datasheet status.....	16



Specifications

AVDD=1.8V, DVDD=1.8V, DVDDCK=1.8V, OVDD=2.5V, 20/40/65/80MSPS clock, 50% clock duty cycle, -1dBFS 8MHz input signal, unless otherwise noted

Parameter	Condition	Min	Typ	Max	Unit
DC accuracy					
No missing codes			Guaranteed		
Offset error	Midscale offset		1		LSB
Gain error	Full scale range deviation from typical			+/- 6	%FS
Gain matching	Gain matching between channels. +/- 3 sigma value at worst case conditions		+/- 0.5		%FS
DNL	Differential nonlinearity		+/- 0.15		LSB
INL	Integral nonlinearity		+/- 0.2		LSB
V _{CM}	Common mode voltage output		V _{AVDD} /2		V
Analog Input					
Input common mode	Analog input common mode voltage	V _{CM} -0.1		V _{CM} +0.2	V
Full scale range	Differential input voltage range		2.0		V _{pp}
Input capacitance	Differential input capacitance		2		pF
Bandwidth	Input Bandwidth	500			MHz
Power Supply					
Core Supply Voltage	Supply voltage to all 1.8V domain pins. See Pin Configuration and Description	1.7	1.8	2.0	V
I/O Supply Voltage	Output driver supply voltage (OVDD). Should be higher than or equal to Core Supply Voltage (V _{OVDD} ≥ V _{DVDD})	1.7	2.5	3.6	V



ASD0400L20

AVDD=1.8V, DVDD=1.8V, DVDDCK=1.8V, OVDD=2.5V, FS=20MSPS clock, 50% clock duty cycle, -1dBFS 8MHz input signal, unless otherwise noted.

Parameter	Condition	Min	Typ	Max	Unit
Performance					
SNR	Signal to Noise Ratio				
	$F_{IN} = 2 \text{ MHz}$		61.7		dBFS
	$F_{IN} = 8 \text{ MHz}$	60	61.6		dBFS
	$F_{IN} \cong FS/2$		61.6		dBFS
SNDR	Signal to Noise and Distortion Ratio				
	$F_{IN} = 2 \text{ MHz}$		61.7		dBFS
	$F_{IN} = 8 \text{ MHz}$	60	61.6		dBFS
	$F_{IN} \cong FS/2$		60.5		dBFS
SFDR	Spurious Free Dynamic Range				
	$F_{IN} = 2 \text{ MHz}$		80		dBc
	$F_{IN} = 8 \text{ MHz}$	70	81		dBc
	$F_{IN} \cong FS/2$		70		dBc
HD2	Second order Harmonic Distortion				
	$F_{IN} = 2 \text{ MHz}$		-90		dBc
	$F_{IN} = 8 \text{ MHz}$	-80	-90		dBc
	$F_{IN} \cong FS/2$		-90		dBc
HD3	Third order Harmonic Distortion				
	$F_{IN} = 2 \text{ MHz}$		-80		dBc
	$F_{IN} = 8 \text{ MHz}$	-70	-81		dBc
	$F_{IN} \cong FS/2$		-70		dBc
ENOB	Effective number of Bits				
	$F_{IN} = 2 \text{ MHz}$		10.0		bits
	$F_{IN} = 8 \text{ MHz}$	9.7	9.9		bits
	$F_{IN} \cong FS/2$		9.8		bits
Crosstalk	Signal crosstalk between channels, $F_{IN1}=8\text{MHz}$, $F_{IN0}=9.9\text{MHz}$				
			-105		dB
Power Supply					
Analog supply current			8.2		mA
Digital supply current	Digital core supply		1.7		mA
Output driver supply	2.5V output driver supply, sine wave input, $F_{IN} = 1 \text{ MHz}$, CK_EXT enabled		2.8		mA
Output driver supply	2.5V output driver supply, sine wave input, $F_{IN} = 1 \text{ MHz}$, CK_EXT disabled		2.3		mA
Analog power			14.8		mW
Digital power	OVDD = 2.5V, 5pF load on output bits, $F_{IN} = 1 \text{ MHz}$, CK_EXT disabled		8.8		mW
Total power Dissipation	OVDD = 2.5V, 5pF load on output bits, $F_{IN} = 1 \text{ MHz}$, CK_EXT disabled		23.6		mW
Power Down			9.9		μW
Sleep Mode 1	Power Dissipation, Sleep mode one channel		15.2		mW
Sleep Mode 2	Power Dissipation, Sleep mode both channels		7.7		mW
Clock Inputs					
Max. Conversion Rate		20			MSPS
Min. Conversion Rate				3	MSPS



ASD0400L40

AVDD=1.8V, DVDD=1.8V, DVDDCK=1.8V, OVDD=2.5V, FS=40MSPS clock, 50% clock duty cycle, -1dBFS 8MHz input signal, unless otherwise noted.

Parameter	Condition	Min	Typ	Max	Unit
Performance					
SNR	Signal to Noise Ratio				
	$F_{IN} = 2 \text{ MHz}$		61.6		dBFS
	$F_{IN} = 8 \text{ MHz}$	60.0	61.6		dBFS
	$F_{IN} \cong FS/2$		61.6		dBFS
SNDR	Signal to Noise and Distortion Ratio				
	$F_{IN} = 2 \text{ MHz}$		61.6		dBFS
	$F_{IN} = 8 \text{ MHz}$	60.0	61.6		dBFS
	$F_{IN} \cong FS/2$		61.2		dBFS
SFDR	Spurious Free Dynamic Range				
	$F_{IN} = 2 \text{ MHz}$		80		dBc
	$F_{IN} = 8 \text{ MHz}$	70	81		dBc
	$F_{IN} \cong FS/2$		72		dBc
HD2	Second order Harmonic Distortion				
	$F_{IN} = 2 \text{ MHz}$		-90		dBc
	$F_{IN} = 8 \text{ MHz}$	-80	-90		dBc
	$F_{IN} \cong FS/2$		-85		dBc
HD3	Third order Harmonic Distortion				
	$F_{IN} = 2 \text{ MHz}$		-80		dBc
	$F_{IN} = 8 \text{ MHz}$	-70	-81		dBc
	$F_{IN} \cong FS/2$		-72		dBc
ENOB	Effective number of Bits				
	$F_{IN} = 2 \text{ MHz}$		9.9		bits
	$F_{IN} = 8 \text{ MHz}$	9.7	9.9		bits
	$F_{IN} \cong FS/2$		9.9		bits
Crosstalk	Signal crosstalk between channels, $F_{IN1}=8\text{MHz}$, $F_{IN0}=9.9\text{MHz}$				
				-100	dB
Power Supply					
Analog supply current			14.4		mA
Digital supply current	Digital core supply		3.4		mA
Output driver supply	2.5V output driver supply, sine wave input, $F_{IN} = 1 \text{ MHz}$, CK_EXT enabled		5.1		mA
Output driver supply	2.5V output driver supply, sine wave input, $F_{IN} = 1 \text{ MHz}$, CK_EXT disabled		4.2		mA
Analog power			25.9		mW
Digital power	OVDD = 2.5V, 5pF load on output bits, $F_{IN} = 1 \text{ MHz}$, CK_EXT disabled		16.6		mW
Total power Dissipation	OVDD = 2.5V, 5pF load on output bits, $F_{IN} = 1 \text{ MHz}$, CK_EXT disabled		42.5		mW
Power Down			9.7		μW
Sleep Mode 1	Power Dissipation, Sleep mode one channel		25.7		mW
Sleep Mode 2	Power Dissipation, Sleep mode both channels		11.3		mW
Clock Inputs					
Max. Conversion Rate		40			MSPS
Min. Conversion Rate				20	MSPS



ASD0400L65

AVDD=1.8V, DVDD=1.8V, DVDDCK=1.8V, OVDD=2.5V, FS=65MSPS clock, 50% clock duty cycle, -1dBFS 8MHz input signal, unless otherwise noted.

Parameter	Condition	Min	Typ	Max	Unit
Performance					
SNR	Signal to Noise Ratio				
	$F_{IN} = 8 \text{ MHz}$	60.0	61.6		dBFS
	$F_{IN} = 20 \text{ MHz}$		61.6		dBFS
	$F_{IN} \cong FS/2$		61.5		dBFS
SNDR	$F_{IN} = 40 \text{ MHz}$		61.3		dBFS
	Signal to Noise and Distortion Ratio				
	$F_{IN} = 8 \text{ MHz}$	60.0	61.6		dBFS
	$F_{IN} = 20 \text{ MHz}$		61.6		dBFS
SFDR	$F_{IN} \cong FS/2$		60.4		dBFS
	$F_{IN} = 40 \text{ MHz}$		61.1		dBFS
	Spurious Free Dynamic Range				
	$F_{IN} = 8 \text{ MHz}$	70	77		dBc
HD2	$F_{IN} = 20 \text{ MHz}$		77		dBc
	$F_{IN} \cong FS/2$		70		dBc
	$F_{IN} = 40 \text{ MHz}$		75		dBc
	Second order Harmonic Distortion				
HD3	$F_{IN} = 8 \text{ MHz}$	-80	-90		dBc
	$F_{IN} = 20 \text{ MHz}$		-95		dBc
	$F_{IN} \cong FS/2$		-85		dBc
	$F_{IN} = 40 \text{ MHz}$		-90		dBc
ENOB	Third order Harmonic Distortion				
	$F_{IN} = 8 \text{ MHz}$	-70	-77		dBc
	$F_{IN} = 20 \text{ MHz}$		-77		dBc
	$F_{IN} \cong FS/2$		-70		dBc
Crosstalk	$F_{IN} = 40 \text{ MHz}$		-75		dBc
	Effective number of Bits				
	$F_{IN} = 8 \text{ MHz}$	9.7	9.9		bits
	$F_{IN} = 20 \text{ MHz}$		9.9		bits
Power Supply	$F_{IN} \cong FS/2$		9.7		bits
	$F_{IN} = 40 \text{ MHz}$		9.9		bits
	Signal crosstalk between channels, $F_{IN1}=8\text{MHz}$, $F_{IN0}=9.9\text{MHz}$		-97		dB
	Signal crosstalk between channels, $F_{IN1}=8\text{MHz}$, $F_{IN0}=9.9\text{MHz}$		-97		dB
Power Supply					
Analog supply current			22.0		mA
Digital supply current	Digital core supply		5.2		mA
Output driver supply	2.5V output driver supply, sine wave input, $F_{IN} = 1 \text{ MHz}$, CK_EXT enabled		7.9		mA
Output driver supply	2.5V output driver supply, sine wave input, $F_{IN} = 1 \text{ MHz}$, CK_EXT disabled		6.4		mA
Analog power			39.6		mW
Digital power	OVDD = 2.5V, 5pF load on output bits, $F_{IN} = 1 \text{ MHz}$, CK_EXT disabled		25.4		mW
Total power Dissipation	OVDD = 2.5V, 5pF load on output bits, $F_{IN} = 1 \text{ MHz}$, CK_EXT disabled		65.0		mW
Power Down			9.3		μW
Sleep Mode 1	Power Dissipation, Sleep mode one channel		38.2		mW
Sleep Mode 2	Power Dissipation, Sleep mode both channels		15.7		mW
Clock Inputs					
Max. Conversion Rate		65			MSPS
Min. Conversion Rate				40	MSPS



ASD0400L80

AVDD=1.8V, DVDD=1.8V, DVDDCK=1.8V, OVDD=2.5V, FS=80MSPS clock, 50% clock duty cycle, -1dBFS 8MHz input signal, unless otherwise noted.

Parameter	Condition	Min	Typ	Max	Unit
Performance					
SNR	Signal to Noise Ratio				
	F _{IN} = 8 MHz	60.0	61.6		dBFS
	F _{IN} = 20 MHz		61.2		dBFS
	F _{IN} = 30 MHz		61.3		dBFS
SNDR	F _{IN} ≅ FS/2		61.3		dBFS
	Signal to Noise and Distortion Ratio				
	F _{IN} = 8 MHz	60.0	61.3		dBFS
	F _{IN} = 20 MHz		60.7		dBFS
SFDR	F _{IN} = 30 MHz		61.0		dBFS
	F _{IN} ≅ FS/2		59.0		dBFS
	Spurious Free Dynamic Range				
	F _{IN} = 8 MHz	70	75		dBc
HD2	F _{IN} = 20 MHz		75		dBc
	F _{IN} = 30 MHz		75		dBc
	F _{IN} ≅ FS/2		65		dBc
	Second order Harmonic Distortion				
HD3	F _{IN} = 8 MHz	-80	-90		dBc
	F _{IN} = 20 MHz		-95		dBc
	F _{IN} = 30 MHz		-90		dBc
	F _{IN} ≅ FS/2		-80		dBc
ENOB	Third order Harmonic Distortion				
	F _{IN} = 8 MHz	-70	-75		dBc
	F _{IN} = 20 MHz		-75		dBc
	F _{IN} = 30 MHz		-75		dBc
Crosstalk	F _{IN} ≅ FS/2		-65		dBc
	Effective number of Bits				
	F _{IN} = 8 MHz	9.7	9.9		bits
	F _{IN} = 20 MHz		9.8		bits
Power Supply	F _{IN} = 30 MHz		9.8		bits
	F _{IN} ≅ FS/2		9.5		bits
	Signal crosstalk between channels, F _{IN1} =8MHz, F _{IN0} =9.9MHz		-95.0		dB
	Signal crosstalk between channels, F _{IN1} =8MHz, F _{IN0} =9.9MHz		-95.0		dB
Power Supply					
Analog supply current			26.5		mA
Digital supply current	Digital core supply		6.1		mA
Output driver supply	2.5V output driver supply, sine wave input, F _{IN} = 1 MHz, CK_EXT enabled		9.5		mA
Output driver supply	2.5V output driver supply, sine wave input, F _{IN} = 1 MHz, CK_EXT disabled		7.6		mA
Analog power			47.7		mW
Digital power	OVDD = 2.5V, 5pF load on output bits, F _{IN} = 1 MHz, CK_EXT disabled		30.0		mW
Total power Dissipation	OVDD = 2.5V, 5pF load on output bits, F _{IN} = 1 MHz, CK_EXT disabled		77.7		mW
Power Down			9.1		μW
Sleep Mode 1	Power Dissipation, Sleep mode one channel		46.1		mW
Sleep Mode 2	Power Dissipation, Sleep mode both channels		18.3		mW
Clock Inputs					
Max. Conversion Rate		80			MSPS
Min. Conversion Rate				65	MSPS



Digital and timing Specifications

AVDD=1.8V, DVDD=1.8V, DVDDCK=1.8V, OVDD=2.5V, Conversion Rate: Max specified, 50% clock duty cycle, -1dBFS input signal, 5 pF capacitive load on data outputs, unless otherwise noted

Parameter	Condition	Min	Typ	Max	Unit
Clock Inputs					
Duty Cycle		20		80	% high
Compliance		CMOS, LVDS, LVPECL, Sine Wave			
Input range	Differential input swing	0.4			V _{pp}
Input range	Differential input swing, sine wave clock input	1.6			V _{pp}
Input common mode voltage	Keep voltages within ground and voltage of OVDD	0.3		V _{OVDD} -0.3	V
Input capacitance	Differential		2		pF
Timing					
T _{PD}	Start up time from Power Down Mode to Active Mode			900	clock cycles
T _{SLP}	Start up time from Sleep Mode to Active Mode			20	clock cycles
T _{OVr}	Out of range recovery time		1		clock cycles
T _{AP}	Aperture Delay		0.8		ns
ε _{rms}	Aperture jitter		< 0.5		ps
T _{LAT}	Pipeline Delay		12		clock cycles
T _D	Output delay (see timing diagram). 5pF load on output bits	3.0		10.0	ns
T _{DC}	Output delay relative to CK_EXT (see timing diagram)	1.0		6.0	ns
Logic Inputs					
V _{HI}	High Level Input Voltage. V _{OVDD} ≥ 3.0V	2			V
V _{HI}	High Level Input Voltage. V _{OVDD} = 1.7V – 3.0V	0.8 · V _{OVDD}			V
V _{LI}	Low Level Input Voltage. V _{OVDD} ≥ 3.0V	0		0.8	V
V _{LI}	Low Level Input Voltage. V _{OVDD} = 1.7V – 3.0V	0		0.2 · V _{OVDD}	V
I _{HI}	High Level Input leakage Current			+/-10	μA
I _{LI}	Low Level Input leakage Current			+/-10	μA
C _I	Input Capacitance		3		pF
Logic Outputs					
V _{HO}	High Level Output Voltage	V _{OVDD} -0.1			V
V _{LO}	Low Level Output Voltage			0.1	V
C _L	Max capacitive load. Post-driver supply voltage equal to pre-driver supply voltage V _{OVDD} = V _{OCVDD}			5	pF
C _L	Max capacitive load. Post-driver supply voltage above 2.25V ⁽¹⁾		10		pF

(1) The outputs will be functional with higher loads. However, it is recommended to keep the load on output data bits as low as possible to keep dynamic currents and resulting switching noise at a minimum



Timing Diagram

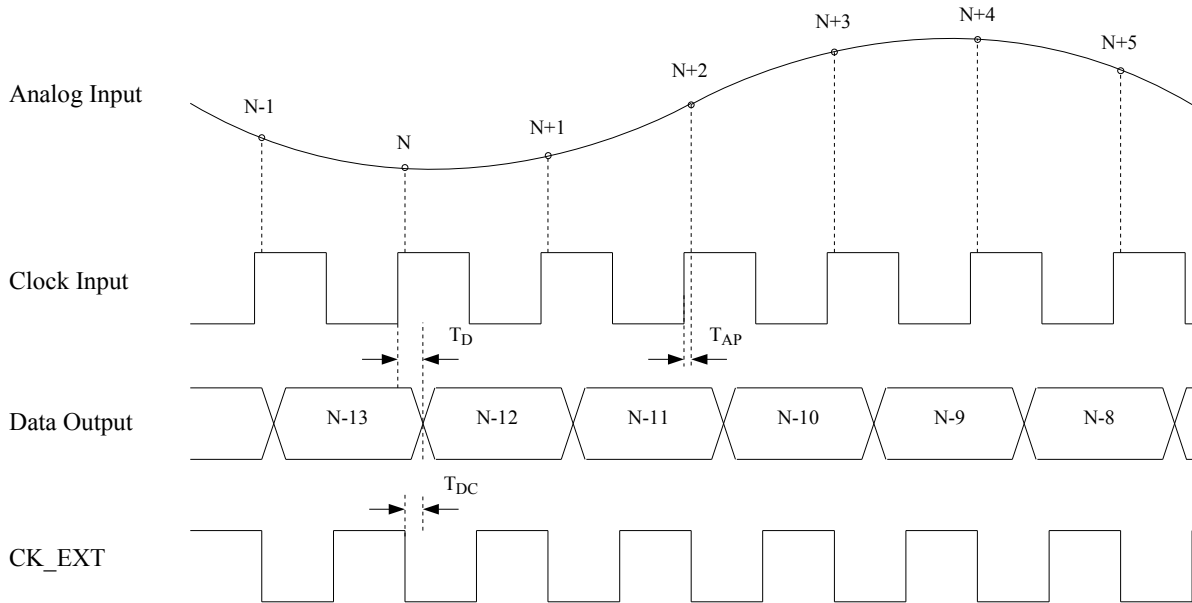

Figure 2: Timing Diagram

Absolute Maximum Ratings

Absolute maximum ratings are limiting values to be applied for short periods of time. Exposure to absolute maximum rating conditions for an extended period of time may reduce device lifetime.

Table 1:

Pin	Pin	Rating
AVDD	AVSS	-0.3V to +2.3V
DVDD	DVSS	-0.3V to +2.3V
AVSS, DVSSCK, DVSS, OVSS	DVSS	-0.3V to +0.3V
OVDD	OVSS	-0.3V to +3.9V
IPx, INx, analog inputs and outputs	AVSS	-0.3V to +2.3V
Digital outputs	OVSS	-0.3V to +3.9V
CKP, CKN	DVSSCK	-0.3V to +3.9V
Digital Inputs	OVSS	-0.3V to +3.9V
Operating temperature		-40 to +85 °C
Storage temperature		-60 to +150 °C
Soldering Profile Qualification		J-STD-020



This device can be damaged by ESD. Even though this product is protected with state-of-the-art ESD protection circuitry, damage may occur if the device is not handled with appropriate precautions. ESD damage may range from device failure to performance degradation. Analog circuitry may be more susceptible to damage as very small parametric changes can result in specification non-compliance.



Pin Configuration and Description

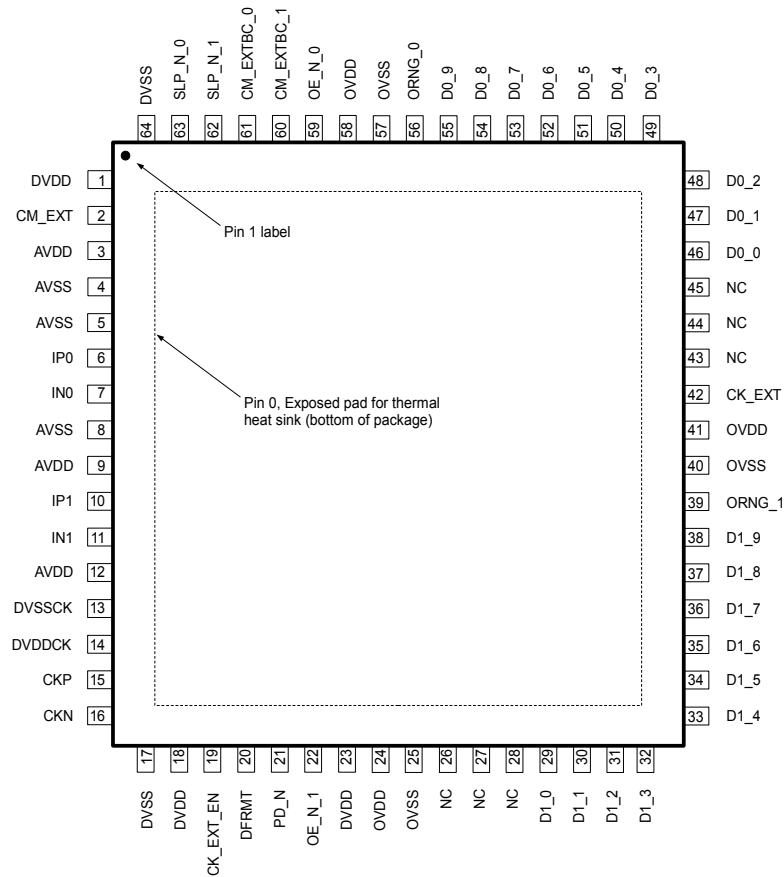

Figure 3: Package Drawing, QFN 64-pin

Table 2: Pin function

Pin #	Name	Description
1, 18, 23	DVDD	Digital and I/O-ring pre driver supply voltage, 1.8V
2	CM_EXT	Common Mode voltage output
3, 9, 12	AVDD	Analog supply voltage, 1.8V
4, 5, 8	AVSS	Analog ground
6, 7	IP0, IN0	Analog input Channel 0 (non-inverting, inverting)
10, 11	IP1, IN1	Analog input Channel 1 (non-inverting, inverting)
13	DVSSCK	Clock circuitry ground
14	DVDDCK	Clock circuitry supply voltage, 1.8V
15	CKP	Clock input, non-inverting (Format: LVDS, LVPECL, CMOS/TTL, Sine Wave)
16	CKN	Clock input, inverting. For CMOS input on CKP, connect CKN to ground.
17, 64	DVSS	Digital circuitry ground
19	CK_EXT_EN	CK_EXT signal enabled when low (zero). Tristate when high.
20	DFRMT	Data format selection. 0: Offset Binary, 1: Two's Complement
21	PD_N	Full chip Power Down mode when Low. All digital outputs reset to zero. After chip power up always apply Power Down mode before using Active Mode to reset chip.
22	OE_N_1	Output Enable Channel 0. Tristate when high



24, 41, 58	OVDD	I/O ring post-driver supply voltage. Voltage range 1.7 to 3.6V
25, 40, 57	OVSS	Ground for I/O ring
26	NC	
27	NC	
28	NC	
29	D1_0	Output Data Channel 1 (LSB)
30	D1_1	Output Data Channel 1
31	D1_2	Output Data Channel 1
32	D1_3	Output Data Channel 1
33	D1_4	Output Data Channel 1
34	D1_5	Output Data Channel 1
35	D1_6	Output Data Channel 1
36	D1_7	Output Data Channel 1
37	D1_8	Output Data Channel 1
38	D1_9	Output Data Channel 1 (MSB)
39	ORNG_1	Out of Range flag Channel 1. High when input signal is out of range
42	CK_EXT	Output clock signal for data synchronization. CMOS levels
43	NC	
44	NC	
45	NC	
46	D0_0	Output Data Channel 0 (LSB)
47	D0_1	Output Data Channel 0
48	D0_2	Output Data Channel 0
49	D0_3	Output Data Channel 0
50	D0_4	Output Data Channel 0
51	D0_5	Output Data Channel 0
52	D0_6	Output Data Channel 0
53	D0_7	Output Data Channel 0
54	D0_8	Output Data Channel 0
55	D0_9	Output Data Channel 0 (MSB)
56	ORNG_0	Out of Range flag Channel 0. High when input signal is out of range
59	OE_N_0	Output Enable Channel 0. Tristate when high
60, 61	CM_EXTBC_1, CM_EXTBC_0	Bias control bits for the buffer driving pin CM_EXT 00: OFF 01: 50uA 10: 500uA 11: 1mA
62, 63	SLP_N_1, SLP_N_0	Sleep Mode 00: Sleep Mode 01: Channel 0 active 10: Channel 1 active 11: Both channels active

Recommended Usage

Analog Input

The analog inputs to the ASD0400 is a switched capacitor track-and-hold amplifier optimized for differential operation. Operation at common mode voltages at mid supply is recommended even if performance will be good for the ranges specified. The CM_EXT pin provides a voltage suitable as common mode voltage reference. The internal buffer for the CM_EXT voltage can be switched off, and driving capabilities can be changed by using the CM_EXTBC

control input.

Figure 4 shows a simplified drawing of the input network. The signal source must have sufficiently low output impedance to charge the sampling capacitors within one clock cycle. A small external resistor (e.g. 22 ohm) in series with each input is recommended as it helps reducing transient currents and dampens ringing behavior. A small differential shunt capacitor at the chip side of the resistors may be used to provide dynamic



charging currents and may improve performance. The resistors form a low pass filter with the capacitor, and values must therefore be determined by requirements for the application.

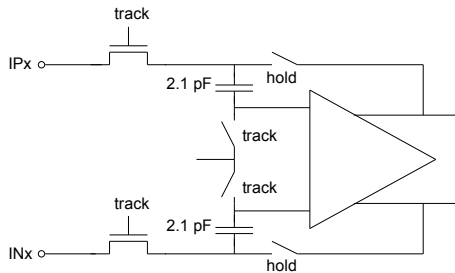

Figure 4: Input configuration

DC-coupling

Figure 5 shows a recommended configuration for DC-coupling. Note that the common mode input voltage must be controlled according to specified values. Preferably, the CM_EXT output should be used as reference to set the common mode voltage.

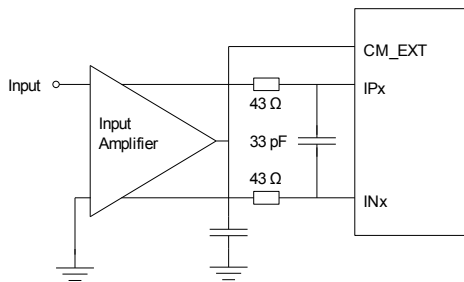

Figure 5: DC coupled input with buffer

The input amplifier could be inside a companion chip or it could be a dedicated amplifier. Several suitable single ended to differential driver amplifiers exist in the market. The system designer should make sure the specifications of the selected amplifier is adequate for the total system, and that driving capabilities comply with the ASD0400 input specifications.

Detailed configuration and usage instructions must be found in the documentation of the selected driver, and the values given in figure 5 must be varied according to the recommendations for the driver.

AC-coupling

A signal transformer or series capacitors can be used to make an AC-coupled input network. Figure 6 shows a recommended configuration using a transformer. Make

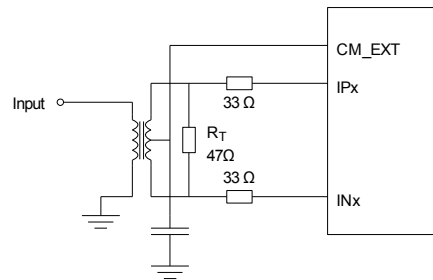

Figure 6: Transformer coupled input

sure that a transformer with sufficient linearity is selected, and that the bandwidth of the transformer is appropriate. The bandwidth should exceed the sampling rate of the ADC with at least a factor of 10. It is also important to minimize phase mismatch between the differential ADC inputs for good HD2 performance. This type of transformer coupled input is the preferred configuration for high frequency signals as most differential amplifiers do not have adequate performance at high frequencies. Magnetic coupling between the transformers and PCB traces may impact channel crosstalk, and must hence be taken into account during PCB layout. If the input signal is traveling a long physical distance from the signal source to the transformer (for example a long cable), kick-backs from the ADC will also travel along this distance. If these kick-backs are not terminated properly at the source side, they are reflected and will add to the input signal at the ADC input. This could reduce the ADC performance. To avoid this effect, the source must effectively terminate the ADC kick-backs, or the traveling distance should be very short. If this problem could not be avoided, the circuit in figure 8 can be used.

Figure 7 shows AC-coupling using capacitors. Resistors from the CM_EXT output, R_{CM} , should be used to bias the differential input signals to the correct voltage. The series capacitor, C_1 , form the high-pass pole with these resistors, and the values must therefore be determined based on the requirement to the high-pass cut-off frequency.

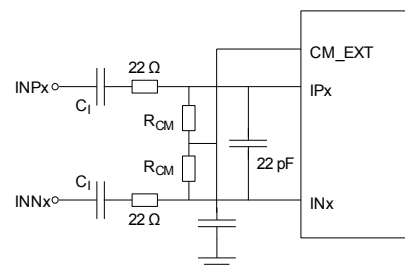

Figure 7: AC coupled input

Note that startup time from Sleep Mode and Power Down Mode will be affected by this filter as the time



required to charge the series capacitors is dependent on the filter cut-off frequency.

If the input signal has a long traveling distance, and the kick-backs from the ADC are not effectively terminated at the signal source, the input network of figure 8 can be used. The configuration in figure 8 is designed to

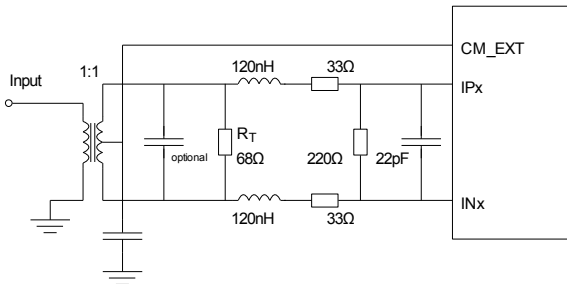

Figure 8: Alternative input network

attenuate the kickback from the ADC and to provide an input impedance that looks as resistive as possible for frequencies below Nyquist. Values of the series inductor will however depend on board design and conversion rate. In some instances a shunt capacitor in parallel with the termination resistor (e.g. 33pF) may improve ADC performance further. This capacitor attenuates the ADC kick-back even more, and minimize the kicks traveling towards the source. However, the impedance match seen into the transformer becomes worse.

Clock Input and Jitter considerations

Typically high-speed ADCs use both clock edges to generate internal timing signals. In the ASD0400 only the rising edge of the clock is used. Hence, input clock duty cycles between 20% and 80% are acceptable.

The input clock can be supplied in a variety of formats. The clock pins are AC-coupled internally. Hence a wide common mode voltage range is accepted. Differential clock sources as LVDS, LVPECL or differential sine wave can be connected directly to the input pins. For CMOS inputs, the CKN pin should be connected to ground, and the CMOS clock signal should be connected to CKP. For differential sine wave clock, the input amplitude must be at least +/- 800 mVpp.

The quality of the input clock is extremely important for high-speed, high-resolution ADCs. The contribution to SNR from clock jitter with a full scale signal at a given frequency is shown in equation 1,

$$SNR_{jitter} = 20 \cdot \log(2 \cdot \pi \cdot f_{IN} \cdot \epsilon_t) \quad (1)$$

where f_{IN} is the signal frequency, and ϵ_t is the total rms jitter measured in seconds. The rms jitter is the total of all jitter sources including the clock generation circuitry, clock distribution and internal ADC circuitry.

For applications where jitter may limit the obtainable performance, it is of utmost importance to limit the clock jitter. This can be obtained by using precise and stable clock references (e.g. crystal oscillators with good jitter specifications) and make sure the clock distribution is well controlled. It might be advantageous to use analog power and ground planes to ensure low noise on the supplies to all circuitry in the clock distribution. It is of utmost importance to avoid crosstalk between the ADC output bits and the clock and between the analog input signal and the clock since such crosstalk often results in harmonic distortion.

The jitter performance is improved with reduced rise and fall times of the input clock. Hence, optimum jitter performance is obtained with LVDS or LVPECL clock with fast edges. CMOS and sine wave clock inputs will result in slightly degraded jitter performance.

If the clock is generated by other circuitry, it should be re-timed with a low jitter master clock as the last operation before it is applied to the ADC clock input.

Digital Outputs

Digital output data are presented on parallel CMOS form. The voltage on the OVDD pin sets the levels of the CMOS outputs. The output drivers are dimensioned to drive a wide range of loads for OVDD above 2.25V, but it is recommended to minimize the load to ensure as low transient switching currents and resulting noise as possible. In applications with a large fanout or large capacitive loads, it is recommended to add external buffers located close to the ADC chip.

The timing is described in the Timing Diagram section. Note that the load or equivalent delay on CK_EXT always should be lower than the load on data outputs to ensure sufficient timing margins.

The digital outputs can be set in tristate mode by setting the OE_N signal high.

The ASD0400 employs digital offset correction. This means that the output code will be 4096 with shorted inputs. However, small mismatches in parasitics at the input can cause this to alter slightly. The offset correction also results in possible loss of codes at the edges of the full scale range. With no offset correction, the ADC would clip in one end before the other, in practice resulting in code loss at the opposite end. With the output being centered digitally, the output will clip, and the out of range flags will be set, before max code is reached. When out of range flags are set, the code is forced to all ones for overrange and all zeros for underrange.

Data Format Selection

The output data are presented on offset binary form when DFRMT is low (connect to OVSS). Setting DFRMT high (connect to OVDD) results in 2's complement output format. Details are shown in table 3.



Table 3: Data Format Description for 2Vpp full scale range

Differential Input Voltage (IPx - INx)	Output data: Dx_9 : Dx_0 (DFRMT = 0, offset binary)	Output Data: Dx_9 : Dx_0 (DFRMT = 1, 2's complement)
1.0 V	11 1111 1111	01 1111 1111
+0.24mV	10 0000 0000	00 0000 0000
-0.24mV	01 1111 1111	11 1111 1111
-1.0V	00 0000 0000	10 0000 0000

Reference Voltages

The reference voltages are internally generated and buffered based on a bandgap voltage reference. No external decoupling is necessary, and the reference voltages are not available externally. This simplifies usage of the ADC since two extremely sensitive pins, otherwise needed, are removed from the interface.

Operational Modes

The operational modes are controlled with the PD_N and SLP_N pins. If PD_N is set low, all other control pins are overridden and the chip is set in Power Down mode. In this mode all circuitry is completely turned off and the internal clock is disabled. Hence, only leakage current contributes to the Power Down Dissipation. The startup time from this mode is longer than for other idle modes as all references need to settle to their final values before normal operation can resume.

The SLP_N bus can be used to power down each channel independently, or to set the full chip in Sleep Mode. In this mode internal clocking is disabled, but some low

bandwidth circuitry is kept on to allow for a short startup time. However, Sleep Mode represents a significant reduction in supply current, and it can be used to save power even for short idle periods.

The input clock should be kept running in all idle modes. However, even lower power dissipation is possible in Power Down mode if the input clock is stopped. In this case it is important to start the input clock prior to enabling active mode.

Startup Initialization

The ASD0400 must be reset prior to normal operation. This is required every time the power supply voltage has been switched off. A reset is performed by applying Power Down mode. Wait until a stable supply voltage has been reached, and pull the PD_N pin for the duration of at least one clock cycle. The input clock must be running continuously during this Power Down period and until active operation is reached. Alternatively the PD pin can be kept low during power-up, and then be set high when the power supply voltage is stable.



Package Mechanical Data

QFN64

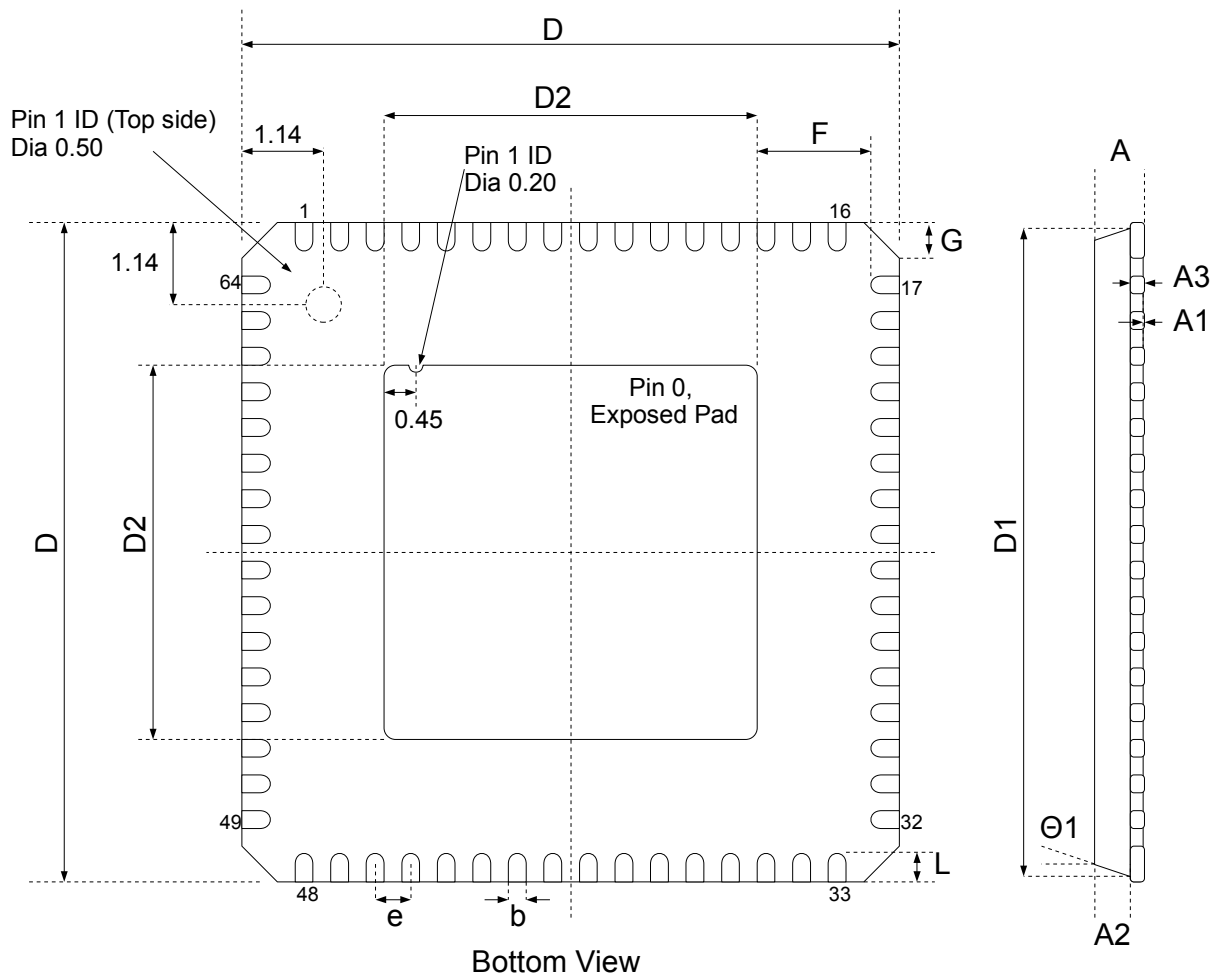

Figure 9: QFN 64 Package dimensions (millimeter unless otherwise noted)

Table 4: Dimensions

Symbol	Millimeter			Inch		
	Min	Typ	Max	Min	Typ	Max
A			0.9			0.035
A1	0.00	0.01	0.05	0.00	0.0004	0.002
A2		0.65	0.7		0.026	0.028
A3		0.2 REF			0.008 REF	
b	0.2	0.25	0.3	0.008	0.010	0.012
D		9.00 bsc			0.354 bsc	
D1		8.75 bsc			0.344 bsc	
D2	3.79	3.99	4.19	0.149	0.157	0.165
L	0.3	0.4	0.5	0.012	0.016	0.020
e		0.50 bsc			0.020 bsc	
Θ1	0°		12°	0°		12°
F	1.9			0.075		
G	0.24	0.42	0.6	0.0096	0.0168	0.024



Product Information

Product	Status	Datasheet revision	Date
ASD0400	Product Specification	v3.2	2010.04.23

Ordering information

Ordering Code	Temp. range	Package type	Package drawing	MSL, Peak temp (1)	Transport Media
ASD0400L20-INR	-40 to +85 °C	64 pin QFN	QFN64	Level 2A	Tape and Reel
ASD0400L40-INR	-40 to +85 °C	64 pin QFN	QFN64	Level 2A	Tape and Reel
ASD0400L65-INR	-40 to +85 °C	64 pin QFN	QFN64	Level 2A	Tape and Reel
ASD0400L80-INR	-40 to +85 °C	64 pin QFN	QFN64	Level 2A	Tape and Reel
ASD0400L20-INT	-40 to +85 °C	64 pin QFN	QFN64	Level 2A	Tray
ASD0400L40-INT	-40 to +85 °C	64 pin QFN	QFN64	Level 2A	Tray
ASD0400L65-INT	-40 to +85 °C	64 pin QFN	QFN64	Level 2A	Tray
ASD0400L80-INT	-40 to +85 °C	64 pin QFN	QFN64	Level 2A	Tray

(1) MSL, Peak Temp: The moisture sensitivity level rating classified according to the JEDEC industry standard and to peak solder temperature.

Datasheet status

Objective Product Specification:

The values and functionality describe design targets only. Specifications and functionality can be changed without notice

Preliminary Product Specification:

The specifications are based on initial design results. Specifications and functionality can be changed without notice.

Product Specification:

Information is current as of publication data. Products conform to specifications according to the terms of Arctic Silicon Devices AS standard warranty. Production does not necessarily require all parameters to be tested.



asd
arctic silicon devices

Arctic Silicon Devices AS
Vestre Rosten 81
N-7075 Tiller
Norway
Tel: +47 73 10 29 00
Fax: +47 73 10 29 19

Information provided in this document is believed to be accurate and reliable. However, no responsibility is assumed by Arctic Silicon Devices AS for its use. Neither is any responsibility assumed for any infringement of patents or other third party rights that may result from the use of the product or information described herein. No license is implicitly or otherwise granted under any patent or patent right of Arctic Silicon Devices AS.

Arctic Silicon Devices AS specifically disclaims any and all liability, including without limitation incidental or consequential damages. It is the responsibility of the user to ensure that in all respects the application in which Arctic Silicon Devices AS products are used is suited to the purpose of the end user.

Life Support Applications :

Products of Arctic Silicon Devices AS (ASD) are not designed for use in life support appliances, devices or systems, where malfunction can result in personal injury. Customers using or selling ASD products for use in such applications do so at their own risk and agree to fully indemnify ASD for any damages resulting from such improper use or sale.

All rights reserved ®. Reproduction in whole or in part is prohibited without the prior written permission of the copyright holder.

template rev. date: 2007.10.03