

## P-Channel Enhancement Mode MOSFET

### Features

- -20V/-1.8A ,  $R_{DS(ON)}=108m\Omega(\text{typ.}) @ V_{GS}=-4.5V$   
 $R_{DS(ON)}=135m\Omega(\text{typ.}) @ V_{GS}=-2.5V$
- Super High Dense Cell Design for Extremely Low  $R_{DS(ON)}$
- Reliable and Rugged
- SOT-23 Package

### Pin Description

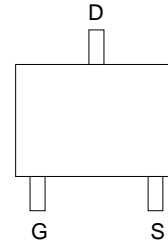

Top View of SOT-23

### Applications

- Power Management in Notebook Computer , Portable Equipment and Battery Powered Systems.

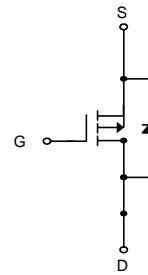

P-Channel MOSFET

### Ordering and Marking Information

<p>APM2313 <span style="font-family: monospace;">□□-□□</span></p> <div style="margin-left: 20px;"> <p>└─ Handling Code</p> <p>└─ Temp. Range</p> <p>└─ Package Code</p> </div>	<p>Package Code A : SOT-23</p> <p>Operating Junction Temp. Range C : -55 to 150°C</p> <p>Handling Code TR : Tape &amp; Reel</p>
<p>APM2313 A : <span style="border: 1px solid black; padding: 2px 5px;">M13X</span></p>	<p>X - Date Code</p>

### Absolute Maximum Ratings ( $T_A = 25^\circ\text{C}$ unless otherwise noted)

Symbol	Parameter	Rating	Unit
$V_{DSS}$	Drain-Source Voltage	-20	V
$V_{GSS}$	Gate-Source Voltage	$\pm 10$	
$I_D^*$	Maximum Drain Current – Continuous	-1.8	A
$I_{DM}$	Maximum Drain Current – Pulsed	-7	

\* Surface Mounted on FR4 Board,  $t \leq 10$  sec.

ANPEC reserves the right to make changes to improve reliability or manufacturability without notice, and advise customers to obtain the latest version of relevant information to verify before placing orders.

**Absolute Maximum Ratings (Cont.)** ( $T_A = 25^\circ\text{C}$  unless otherwise noted)

Symbol	Parameter	Rating	Unit
$P_D$	Maximum Power Dissipation	$T_A=25^\circ\text{C}$	1.25
		$T_A=100^\circ\text{C}$	0.5
$T_J$	Maximum Junction Temperature	150	$^\circ\text{C}$
$T_{\text{STG}}$	Storage Temperature Range	-55 to 150	$^\circ\text{C}$
$R_{\theta JA}$	Thermal Resistance – Junction to Ambient	100	$^\circ\text{C/W}$

**Electrical Characteristics** ( $T_A = 25^\circ\text{C}$  unless otherwise noted)

Symbol	Parameter	Test Condition	APM2313			Unit
			Min.	Typ.	Max.	
<b>Static</b>						
$BV_{\text{DSS}}$	Drain-Source Breakdown Voltage	$V_{\text{GS}}=0\text{V}$ , $I_{\text{DS}}=-250\mu\text{A}$	-20			V
$I_{\text{DSS}}$	Zero Gate Voltage Drain Current	$V_{\text{DS}}=-16\text{V}$ , $V_{\text{GS}}=0\text{V}$			-1	$\mu\text{A}$
$V_{\text{GS(th)}}$	Gate Threshold Voltage	$V_{\text{DS}}=V_{\text{GS}}$ , $I_{\text{DS}}=-250\mu\text{A}$	-0.5	-0.7	-1	V
$I_{\text{GSS}}$	Gate Leakage Current	$V_{\text{GS}}=\pm 10\text{V}$ , $V_{\text{DS}}=0\text{V}$			$\pm 100$	nA
$R_{\text{DS(ON)}}^a$	Drain-Source On-state Resistance	$V_{\text{GS}}=-4.5\text{V}$ , $I_{\text{DS}}=-1.8\text{A}$		108	140	m $\Omega$
		$V_{\text{GS}}=-2.5\text{V}$ , $I_{\text{DS}}=-0.8\text{A}$		135	175	
$V_{\text{SD}}^a$	Diode Forward Voltage	$I_{\text{SD}}=-0.5\text{A}$ , $V_{\text{GS}}=0\text{V}$		-0.8	-1.3	V
<b>Dynamic<sup>b</sup></b>						
$Q_g$	Total Gate Charge	$V_{\text{DS}}=-10\text{V}$ , $I_{\text{DS}}=-1.8\text{A}$ , $V_{\text{GS}}=-4.5\text{V}$		5.3	7	nC
$Q_{\text{gs}}$	Gate-Source Charge			1.04		
$Q_{\text{gd}}$	Gate-Drain Charge			0.62		
$t_{\text{d(ON)}}$	Turn-on Delay Time	$V_{\text{DD}}=-10\text{V}$ , $I_{\text{DS}}=-1\text{A}$ , $V_{\text{GEN}}=-4.5\text{V}$ , $R_G=6\Omega$		8	16	ns
$T_r$	Turn-on Rise Time			7	15	
$t_{\text{d(OFF)}}$	Turn-off Delay Time			18	35	
$T_f$	Turn-off Fall Time			8	15	
$C_{\text{iss}}$	Input Capacitance	$V_{\text{GS}}=0\text{V}$		435		pF
$C_{\text{oss}}$	Output Capacitance	$V_{\text{DS}}=-15\text{V}$		120		
$C_{\text{riss}}$	Reverse Transfer Capacitance	Frequency=1.0MHz		65		

**Notes**
<sup>a</sup> : Pulse test ; pulse width  $\leq 300\mu\text{s}$ , duty cycle  $\leq 2\%$ 
<sup>b</sup> : Guaranteed by design, not subject to production testing

## Typical Characteristics

Output Characteristics

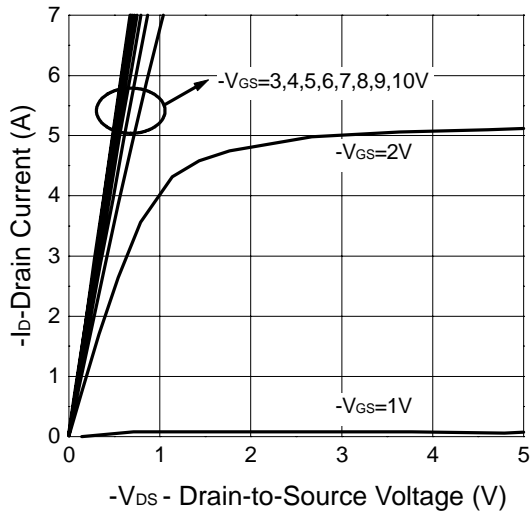

Transfer Characteristics

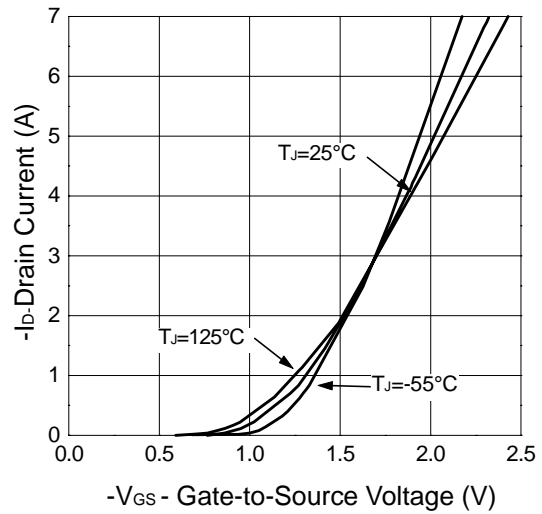

Threshold Voltage vs. Junction Temperature

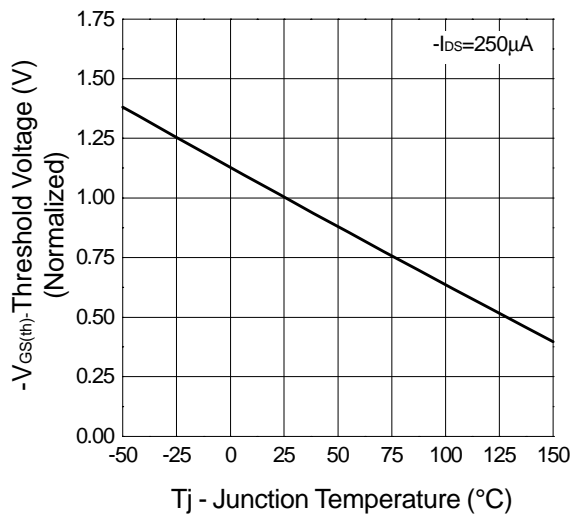

On-Resistance vs. Drain Current

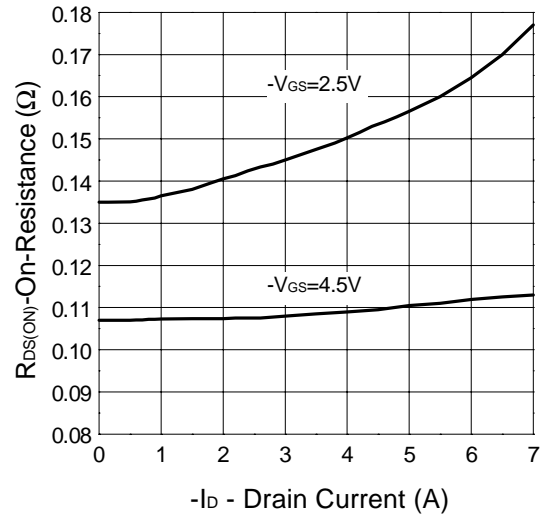

Typical Characteristics (Cont.)

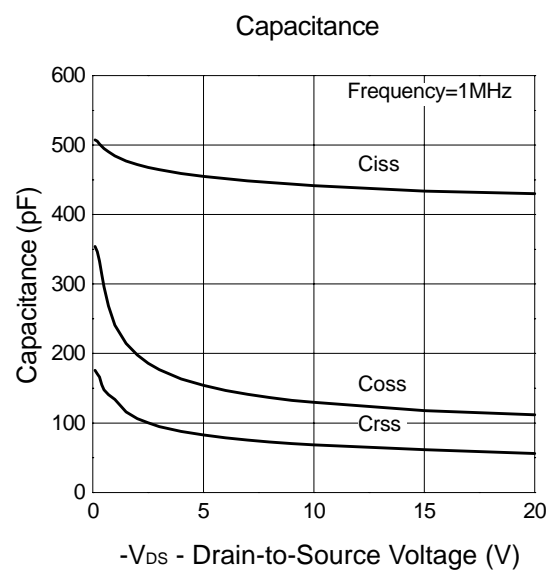
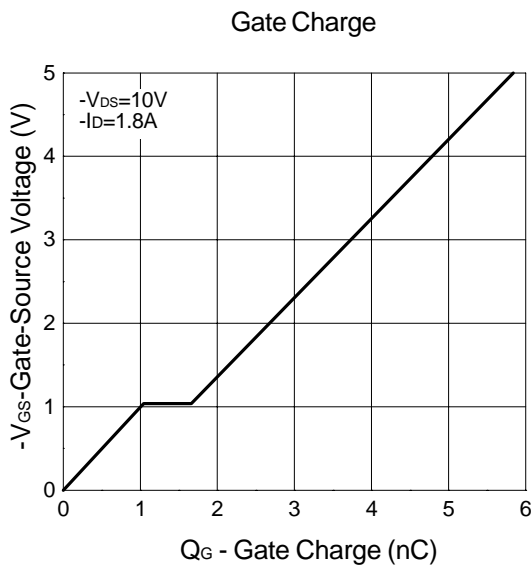
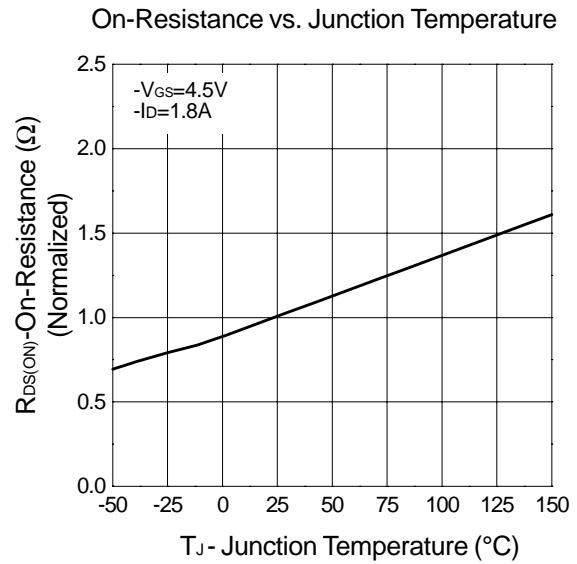
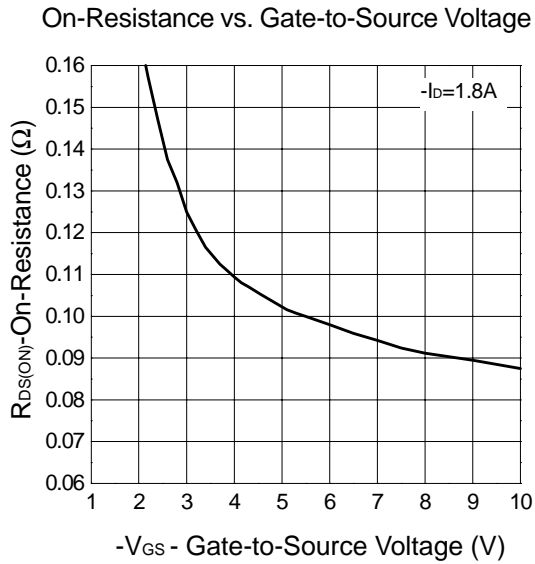

Typical Characteristics (Cont.)

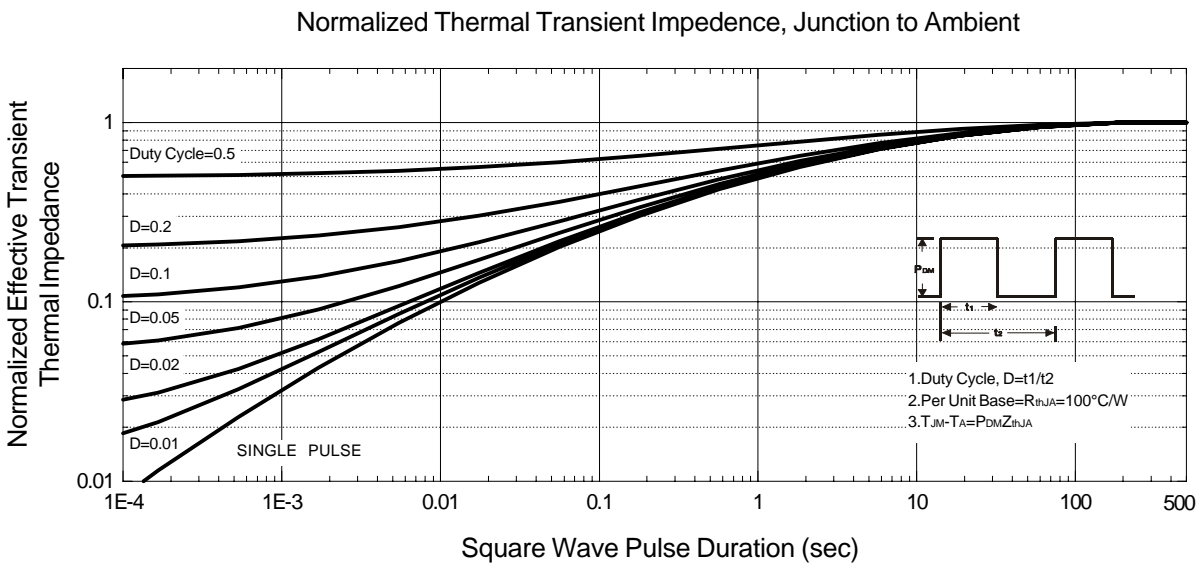
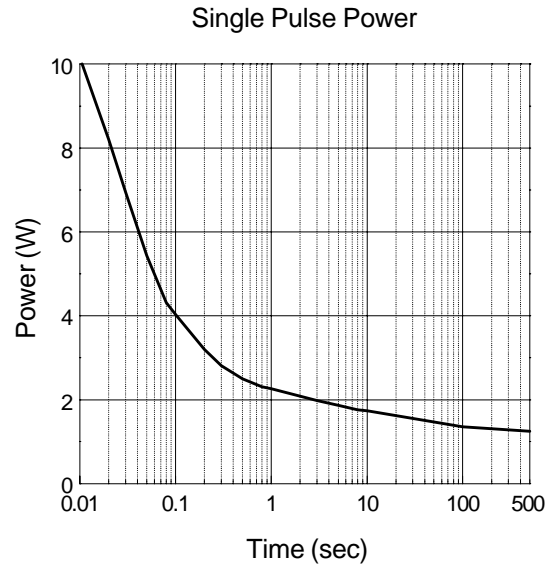
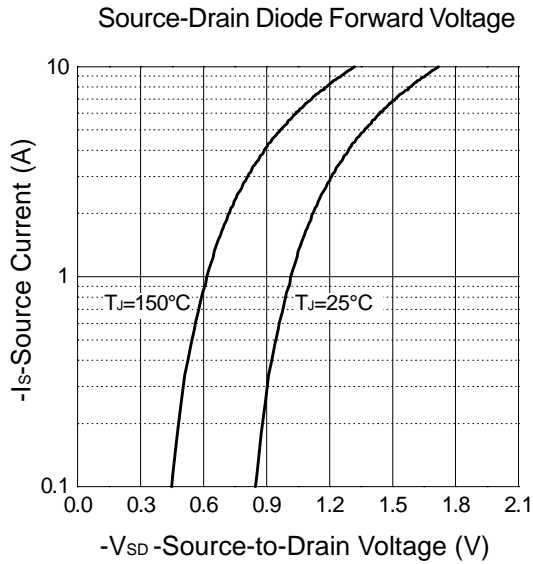

## Packaging Information

SOT-23

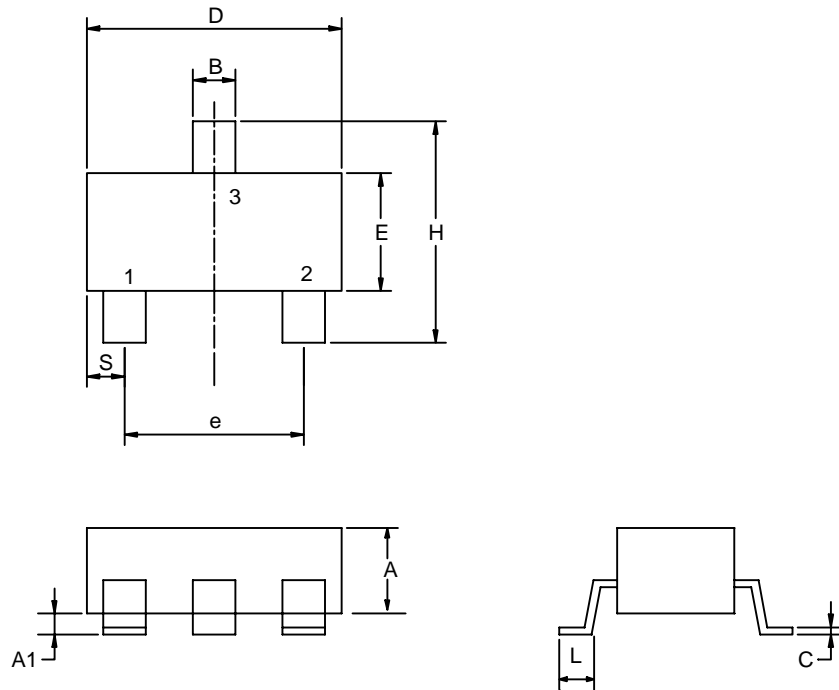

Dim	Millimeters		Inches	
	Min.	Max.	Min.	Max.
A	1.00	1.30	0.039	0.051
A1	0.00	0.10	0.000	0.004
B	0.35	0.51	0.014	0.020
C	0.10	0.25	0.004	0.010
D	2.70	3.10	0.106	0.122
E	1.40	1.80	0.055	0.071
e	1.90 BSC		0.075 BSC	
H	2.40	3.00	0.094	0.118
L	0.37		0.0015	

## Physical Specifications

Terminal Material	Solder-Plated Copper (Solder Material : 90/10 or 63/37 SnPb)
Lead Solderability	Meets EIA Specification RSI86-91, ANSI/J-STD-002 Category 3.

## Reflow Condition (IR/Convection or VPR Reflow)

Reference JEDEC Standard J-STD-020A APRIL 1999

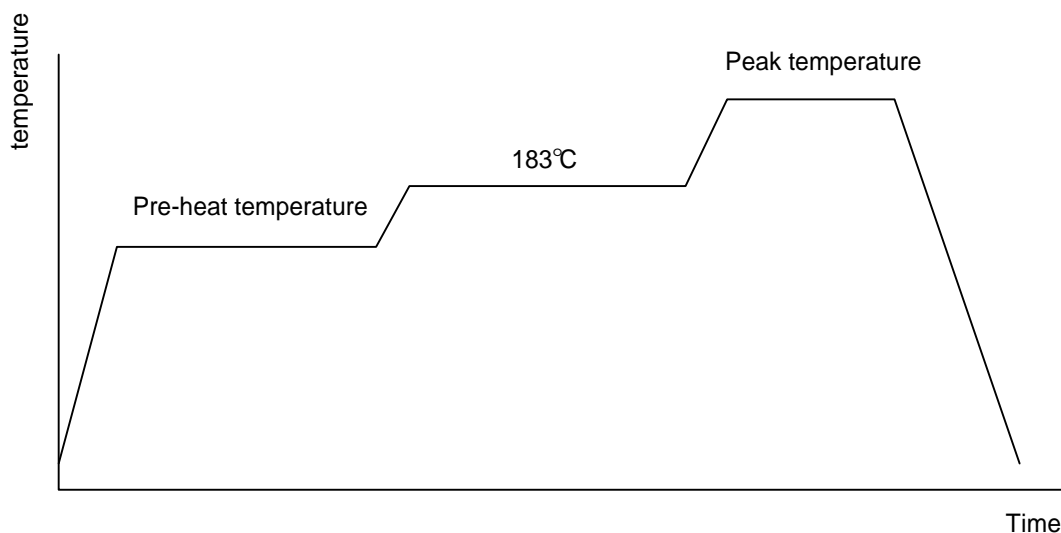

## Classification Reflow Profiles

	Convection or IR/ Convection	VPR
Average ramp-up rate(183°C to Peak)	3°C/second max.	10 °C /second max.
Preheat temperature 125 ± 25°C)	120 seconds max	
Temperature maintained above 183°C	60 – 150 seconds	
Time within 5°C of actual peak temperature	10 –20 seconds	60 seconds
Peak temperature range	220 +5/-0°C or 235 +5/-0°C	215-219°C or 235 +5/-0°C
Ramp-down rate	6 °C /second max.	10 °C /second max.
Time 25°C to peak temperature	6 minutes max.	

## Package Reflow Conditions

pkg. thickness ≥ 2.5mm and all bgas	pkg. thickness < 2.5mm and pkg. volume ≥ 350 mm <sup>3</sup>	pkg. thickness < 2.5mm and pkg. volume < 350mm <sup>3</sup>
Convection 220 +5/-0 °C		Convection 235 +5/-0 °C
VPR 215-219 °C		VPR 235 +5/-0 °C
IR/Convection 220 +5/-0 °C		IR/Convection 235 +5/-0 °C

## Reliability test program

Test item	Method	Description
SOLDERABILITY	MIL-STD-883D-2003	245°C, 5 SEC
HOLT	MIL-STD 883D-1005.7	1000 Hrs Bias @ 125°C
PCT	JESD-22-B, A102	168 Hrs, 100% RH, 121°C
TST	MIL-STD 883D-1011.9	-65°C ~ 150°C, 200 Cycles

## Carrier Tape

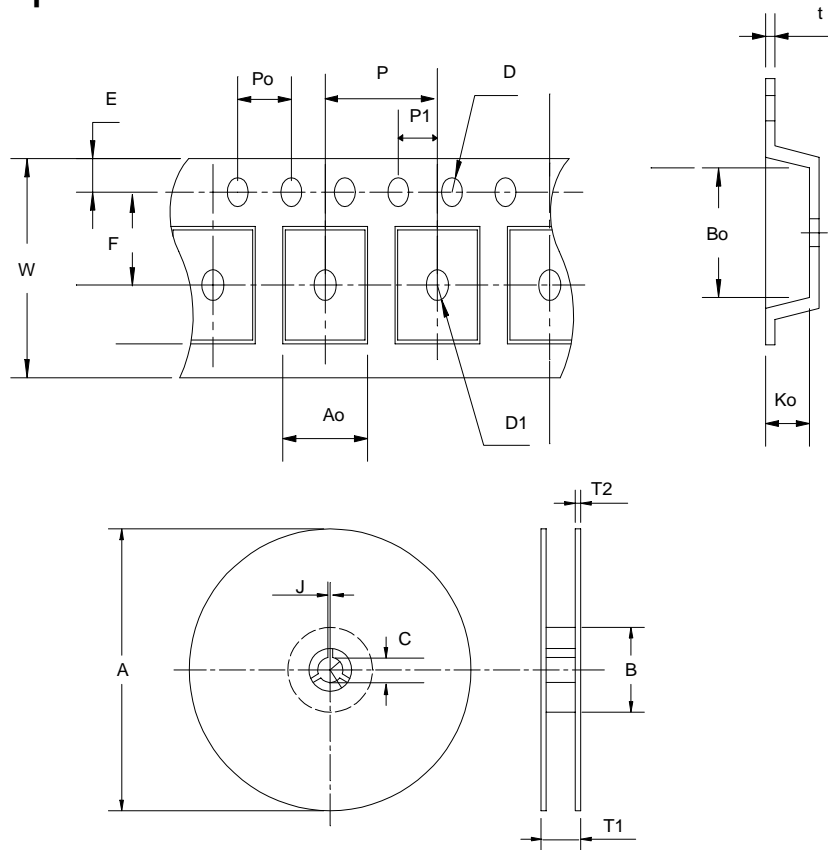

Application	A	B	C	J	T1	T2	W	P	E
SOT-23	178±1	72 ± 1.0	13.0 + 0.2	2.5 ± 0.15	8.4 ± 2	1.5 ± 0.3	8.0 <sup>+0.3</sup> <sub>-0.3</sub>	4 ± 0.1	1.75 ± 0.1
	F	D	D1	Po	P1	Ao	Bo	Ko	t
	3.5 ± 0.05	1.5 + 0.1	1.5 + 0.1	4.0 ± 0.1	2.0 ± 0.1	3.15 ± 0.1	3.2 ± 0.1	1.4 ± 0.1	0.2 ± 0.03



## Cover Tape Dimensions

Application	Carrier Width	Cover Tape Width	Devices Per Reel
SOT- 23	8	5.3	3000

## Customer Service

### **Anpec Electronics Corp.**

Head Office :

5F, No. 2 Li-Hsin Road, SBIP,

Hsin-Chu, Taiwan, R.O.C.

Tel : 886-3-5642000

Fax : 886-3-5642050

Taipei Branch :

7F, No. 137, Lane 235, Pac Chiao Rd.,

Hsin Tien City, Taipei Hsien, Taiwan, R. O. C.

Tel : 886-2-89191368

Fax : 886-2-89191369