

Linear motion 0.2 watt composition slide control

Features

- Innovative AC power switch, SPST or SPDT, available on mono element resistors
- 10-60mm slider travel
- 0.2 watt power rating (resistor)
- 1000 watt power rating (SPST switch)
- 600 watt power rating (SPDT switch)
- Detent at 50% travel available
- Multiple detents available
- Single or dual element designs
- Economical
- Wide resistance range
- Slim construction permits stacking many units in a small space

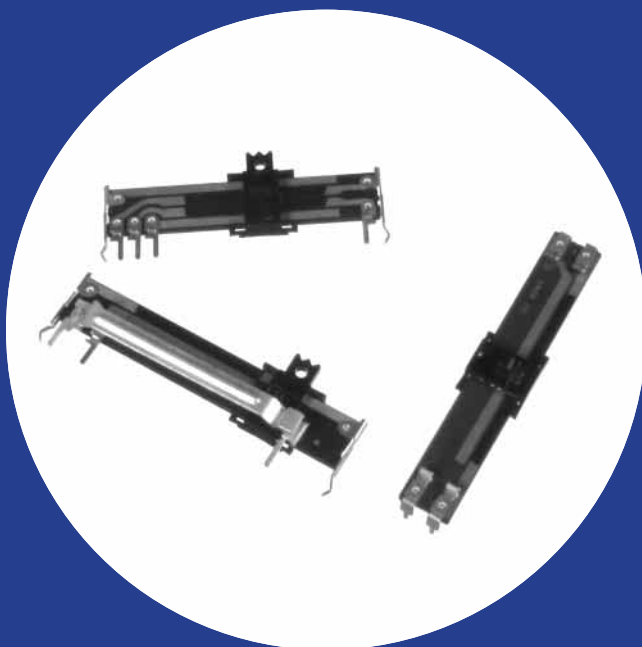

Electrical and Mechanical Specifications

Resistance Range

500 ohms through 1 megohm

Resistance Tolerance

Standard $\pm 20\%$
Available $\pm 10\%$

Resistance Tapers

Standard: Linear
Special: Available upon request

Insulation Resistance

10 megohms at 250 VDC

Voltage Rating

Across end terminals
Linear curves—300 VDC
(Not to exceed wattage ratings)

Power Rating, watts

Size Taper	10mm	15mm 20mm	30mm	45mm	60mm
Linear	0.05w	0.1w	0.2w	0.25w	0.5w
Non-linear	0.025w	0.05w	0.1w	0.15w	0.25w

Power Switch (optional)

SPST - 10,000 cycles carrying 1000 watts 120 VAC
(Tungsten-filament)
10,000 cycles switching 6A 120 VAC @ 0.75-0.80PF
(Inductive load)
SPDT - 10,000 cycles carrying 600 watts 120 VAC
(Tungsten-filament)
6,000 cycles switching 3A 120 VAC @ 0.75-0.80PF
(Inductive load)

Slide Travel

X and U Style: 10, 15, 20, 30, 45, and 60mm
V Style: 10, 15, 25, 40, and 55mm

Switch: 20mm = 17mm electrical + 3mm switch
30mm = 27mm electrical + 3mm switch

Actuator Information

See Illustrations, page 4 (Actuator Styles)

Operating Force

Either direction 20-150 gf
Switch OFF force: 100-500 gf
Stop Strength: 3K gf maximum, measured at
base of slider

Detent Force (detent optional)

Leaving detent: 20-200 gf over operating force

Operating Life

10,000 cycles

Type V448 MONO

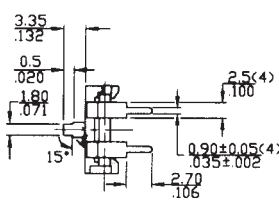
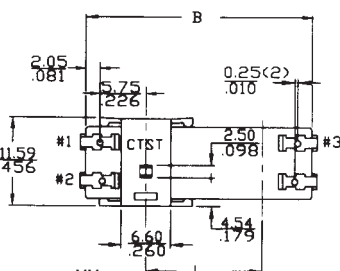
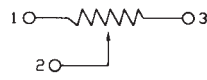
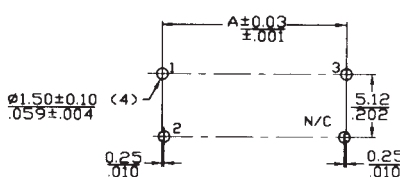
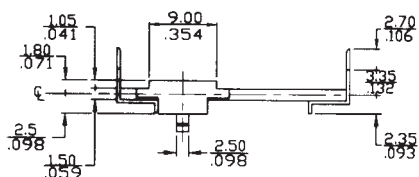

DIMENSION: MM
INCH

MODEL	DIMENSIONS		
	L (Travel)	A	B
V448-10M	10/ .394	30.20/1.189	28.70/1.130
V448-15M	15/ .591	35.20/1.387	33.70/1.372
V448-25M	25/ .984	45.20/1.180	43.70/1.721
V448-40M	40/ 1.575	60.20/2.370	58.70/2.311
V448-55M	55/ 2.166	75.20/2.961	73.70/2.902

Type U448 MONO

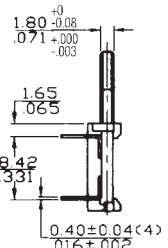
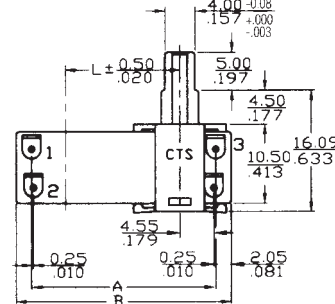
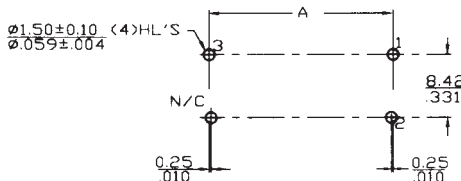
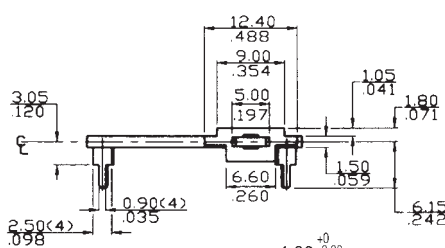

DIMENSION: MM
INCH

MODEL	DIMENSIONS		
	L (Travel)	A	B
U448-10M	10/ .394	19.60/ .772	23.70/ .933
U448-15M	15/ .591	24.60/ .969	28.70/ 1.130
U448-20M	20/ .787	29.60/ 1.165	33.70/ 1.327
U448-30M	30/ 1.181	39.60/ 1.559	43.70/ 1.720
U448-45M	45/ 1.772	54.60/ 2.149	58.70/ 2.311
U448-60M	60/ 2.362	69.60/ 2.740	73.70/ 2.902

Type U448 DUAL

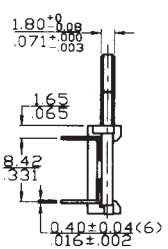
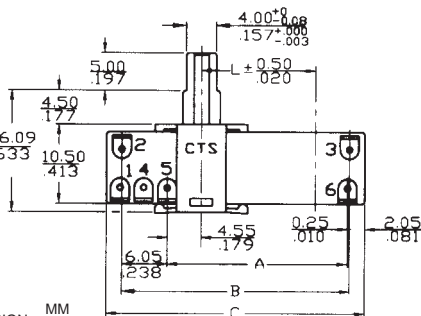
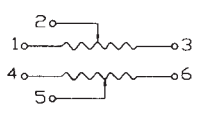
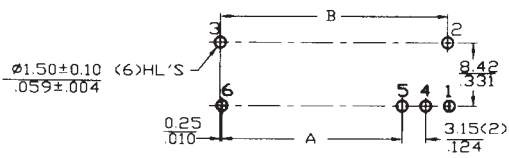
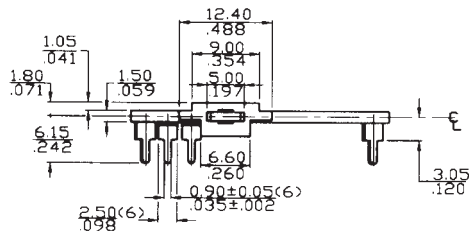

DIMENSION: MM
INCH

MODEL	DIMENSIONS			
	L (Travel)	A	B	C
U448-10D	10/ .394	19.10/ .752	25.40/ 1.000	29.50/ 1.161
U448-15D	15/ .591	24.10/ .949	30.40/ 1.197	34.50/ 1.359
U448-20D	20/ .787	29.10/ 1.146	35.40/ 1.394	39.50/ 1.555
U448-30D	30/ 1.181	39.10/ 1.539	45.40/ 1.787	49.50/ 1.949
U448-45D	45/ 1.772	54.10/ 2.130	60.40/ 2.378	64.50/ 2.539
U448-60D	60/ 2.362	69.10/ 2.721	75.40/ 2.969	79.50/ 3.131

Type X448 MONO

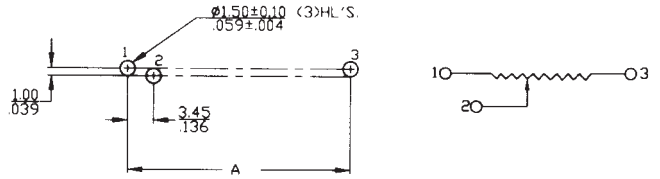
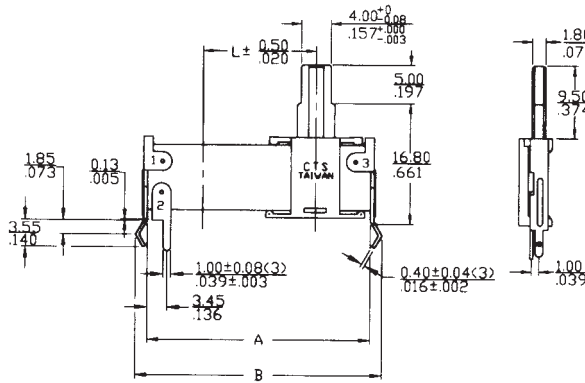

MODEL	DIMENSIONS		
	L (Travel)	A	B
X448-10M	10/ .394	24.50/ .965	26.60/1.047
X448-15M	15/ .591	29.50/1.161	31.60/1.244
X448-20M	20/ .787	34.50/1.359	36.60/1.441
X448-30M	30/ 1.181	44.50/1.752	46.60/1.835
X448-45M	45/ 1.772	59.50/2.343	61.60/2.425
X448-60M	60/ 2.362	74.50/2.934	76.60/3.016

DIMENSION: MM
INCH

Type X448 DUAL

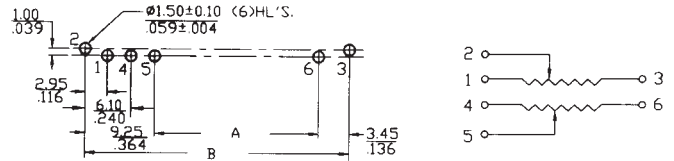
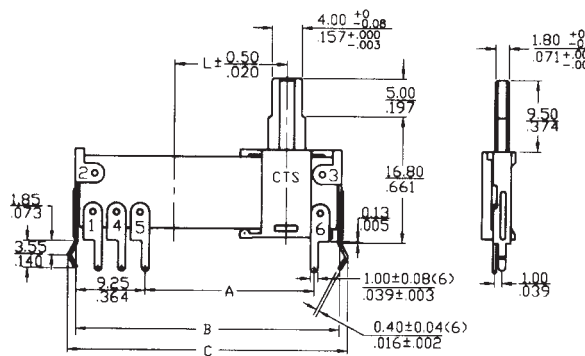

MODEL	DIMENSIONS			
	L (Travel)	A	B	C
X448-10D	10/ .394	17.60/ .693	30.30/1.193	32.40/1.276
X448-15D	15/ .591	22.60/ .890	35.30/1.390	37.40/1.473
X448-20D	20/ .787	27.60/1.087	40.30/1.587	42.40/1.669
X448-30D	30/ 1.181	37.60/1.481	50.30/1.981	52.40/2.063
X448-45D	45/ 1.772	52.60/2.071	65.30/2.571	67.40/2.654
X448-60D	60/ 2.362	67.60/2.662	80.30/3.162	82.40/3.248

DIMENSION: MM
INCH

Type X448 MONO W/SPST SWITCH

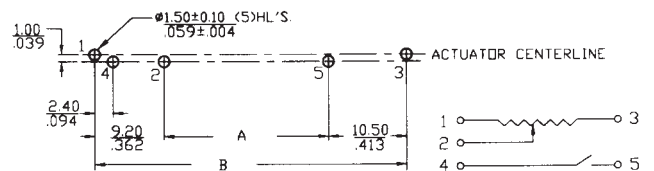
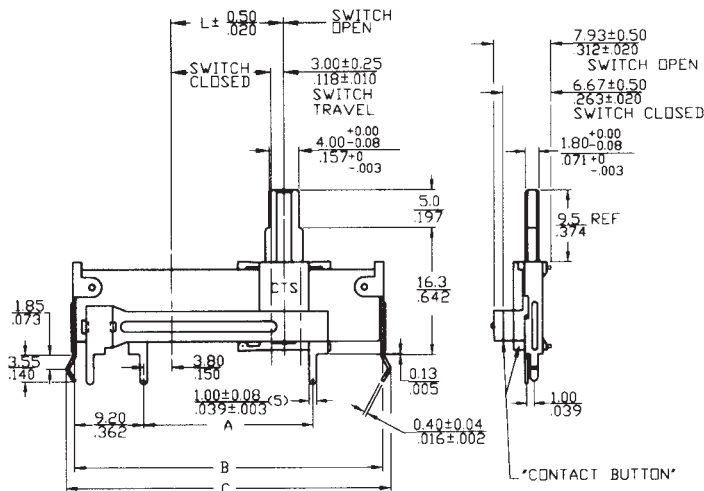

MODEL	DIMENSIONS			
	L (Travel)	A	B	C
X448-20MS	20/ .787	27.50/1.083	47.20/1.859	49.20/1.937
X448-30MS	30/ 1.181	37.50/1.476	57.20/2.272	59.20/2.331

DIMENSION: MM
INCH

Type X448 MONO W/SPDT SWITCH

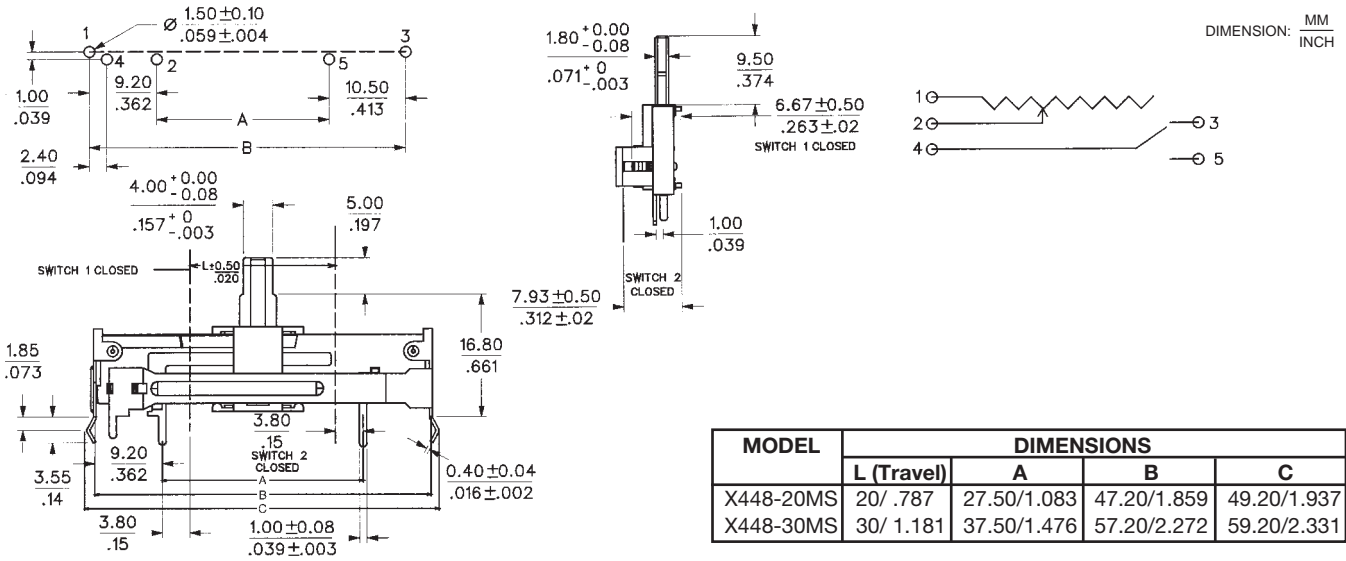

Actuator Styles

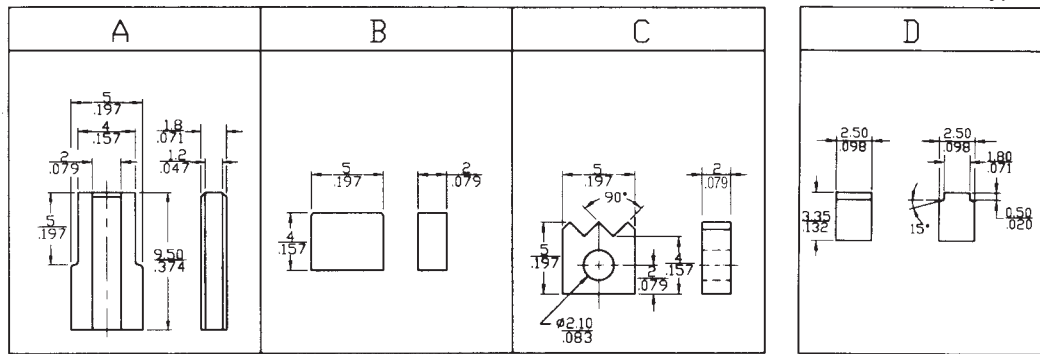

Ordering Information

448 U <div style="border: 1px solid black; padding: 5px; margin-top: 10px;"> <p>MOUNTING STYLE</p> <p>U Actuator—parallel to PC Board</p> <p>X Actuator—perpendicular to PC Board</p> <p>V Actuator—low profile perpendicular to PCB</p> </div>	E <div style="border: 1px solid black; padding: 5px; margin-top: 10px;"> <p>TRAVEL</p> <table style="width: 100%; border-collapse: collapse;"> <tr> <td>U & X Types</td> <td>V-Type</td> </tr> <tr> <td>A 10mm</td> <td>A 10mm</td> </tr> <tr> <td>B 15mm</td> <td>B 15mm</td> </tr> <tr> <td>C 20mm</td> <td>C 25mm</td> </tr> <tr> <td>D 30mm</td> <td>D 40mm</td> </tr> <tr> <td>E 45mm</td> <td>E 55mm</td> </tr> <tr> <td>F 60mm</td> <td></td> </tr> </table> </div>	U & X Types	V-Type	A 10mm	A 10mm	B 15mm	B 15mm	C 20mm	C 25mm	D 30mm	D 40mm	E 45mm	E 55mm	F 60mm		2 <div style="border: 1px solid black; padding: 5px; margin-top: 10px;"> <p>ACTUATOR STYLE</p> <table style="width: 100%; border-collapse: collapse;"> <tr> <td>U & X Types</td> <td>V-Type</td> </tr> <tr> <td>2: Style A: 9.5mm</td> <td>1: Style D: 3.35mm</td> </tr> <tr> <td>3: Style B: 4.0mm</td> <td></td> </tr> <tr> <td>4: Style C: 5.0mm</td> <td></td> </tr> </table> </div>	U & X Types	V-Type	2: Style A: 9.5mm	1: Style D: 3.35mm	3: Style B: 4.0mm		4: Style C: 5.0mm		102 <div style="border: 1px solid black; padding: 5px; margin-top: 10px;"> <p>RESISTANCE CODE (EXAMPLES)</p> <table style="width: 100%; border-collapse: collapse;"> <tr> <th>Code</th> <th>Resistance</th> </tr> <tr> <td>501</td> <td>500 ohms</td> </tr> <tr> <td>102</td> <td>1K</td> </tr> <tr> <td>252</td> <td>2.5K</td> </tr> <tr> <td>502</td> <td>5K</td> </tr> <tr> <td>103</td> <td>10K</td> </tr> <tr> <td>253</td> <td>25K</td> </tr> <tr> <td>503</td> <td>50K</td> </tr> <tr> <td>104</td> <td>100K</td> </tr> </table> </div>	Code	Resistance	501	500 ohms	102	1K	252	2.5K	502	5K	103	10K	253	25K	503	50K	104	100K	B <div style="border: 1px solid black; padding: 5px; margin-top: 10px;"> <p>RESISTANCE TOLERANCE</p> <p>A ±10%</p> <p>B ±20%</p> <p>C ±30%</p> </div>	D <div style="border: 1px solid black; padding: 5px; margin-top: 10px;"> <p>TAPER</p> <p>D Linear</p> <p>A CW 10% audio</p> <p>B CCW 10% audio</p> </div>	N <div style="border: 1px solid black; padding: 5px; margin-top: 10px;"> <p>SPECIALS</p> <p>N No specials</p> <p>C Center detent</p> <p>M Multiple detent</p> <p>S SPST Power Switch (20 & 30mm X type only)</p> <p>D SPDT Power Switch (20 & 30mm X type only)</p> </div>
U & X Types	V-Type																																													
A 10mm	A 10mm																																													
B 15mm	B 15mm																																													
C 20mm	C 25mm																																													
D 30mm	D 40mm																																													
E 45mm	E 55mm																																													
F 60mm																																														
U & X Types	V-Type																																													
2: Style A: 9.5mm	1: Style D: 3.35mm																																													
3: Style B: 4.0mm																																														
4: Style C: 5.0mm																																														
Code	Resistance																																													
501	500 ohms																																													
102	1K																																													
252	2.5K																																													
502	5K																																													
103	10K																																													
253	25K																																													
503	50K																																													
104	100K																																													

For dual elements: Consult factory

Order From:

CTS CORPORATION, ELECTROCOMPONENTS / 1601 Mishawaka Street / Elkhart, Indiana 46514
 North America Toll Free (888) 287-4690 / (219) 296-6700 / FAX: (219) 293-1240 <http://www.ctscorp.com>

CTS COMPONENTS TAIWAN, LTD. / 7, Central 6th Road (Chung Liu Road) / P.O. Box 26-20
 Kaohsiung Export Processing Zone / Kaohsiung, Taiwan, Rep. of China
 (07) 8216145 / FAX: (07) 8417642.8110040