



**ES Series
RF Receiver
Data Guide**

Wireless made simple[®]

Warning: Linx radio frequency ("RF") products may be used to control machinery or devices remotely, including machinery or devices that can cause death, bodily injuries, and/or property damage if improperly or inadvertently triggered, particularly in industrial settings or other applications implicating life-safety concerns. No Linx Technologies product is intended for use in any application without redundancies where the safety of life or property is at risk.

The customers and users of devices and machinery controlled with RF products must understand and must use all appropriate safety procedures in connection with the devices, including without limitation, using appropriate safety procedures to prevent inadvertent triggering by the user of the device and using appropriate security codes to prevent triggering of the remote controlled machine or device by users of other remote controllers.

Do not use this or any Linx product to trigger an action directly from the data line or RSSI lines without a protocol or encoder/decoder to validate the data. Without validation, any signal from another unrelated transmitter in the environment received by the module could inadvertently trigger the action.

All RF products are susceptible to RF interference that can prevent communication. RF products without frequency agility or hopping implemented are more subject to interference. This module does not have a frequency hopping protocol built in.

Do not use any Linx product over the limits in this data guide. Excessive voltage or extended operation at the maximum voltage could cause product failure. Exceeding the reflow temperature profile could cause product failure which is not immediately evident.

Do not make any physical or electrical modifications to any Linx product. This will void the warranty and regulatory and UL certifications and may cause product failure which is not immediately evident.

Table of Contents

1	Description
1	Features
1	Applications
2	Ordering Information
2	Electrical Specifications
4	Absolute Maximum Ratings
4	Typical Performance Graphs
7	Pin Assignments
7	Pin Descriptions
8	Module Description
8	Theory of Operation
9	Using the PDN Line
9	ESD Concerns
10	Using the RSSI Line
10	Using the ES Series Receiver for Analog Applications
11	Using the ES for Digital Applications
13	Power Supply Requirements
13	Protocol Guidelines
14	Interference Considerations
15	Pad Layout
15	Board Layout Guidelines
17	Microstrip Details
18	Production Guidelines
18	Hand Assembly
18	Automated Assembly
20	Helpful Application Notes From Linx
21	Antenna Considerations
22	General Antenna Rules
24	Common Antenna Styles
26	Regulatory Considerations

ES Series RF Receiver

Data Guide



Description

Housed in a tiny SMD package, the ES Series offers an impressive combination of features, performance and cost-effectiveness. The ES utilizes an advanced synthesized FM / FSK architecture to provide superior performance and noise immunity when compared to AM / OOK solutions. A 56kbps maximum data rate and wide-range analog capability make the ES Series equally at home with digital data or analog sources such as audio.

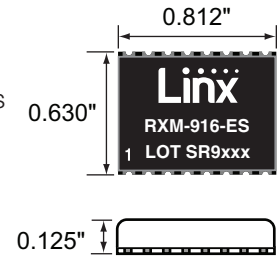

Figure 1: Package Dimensions

It provides a host of useful features including RSSI, PDN, and an audio reference. The ES operates in the 900MHz (US) or 869MHz (EU) band, which in North America allows a wide variety of applications, including data links, audio links, home and industrial automation, security, remote control / command and monitoring. Like all Linx modules, the ES Series requires no tuning or external RF components except an antenna.

Features

- Ultra-compact SMD package
- FM / FSK modulation
- Wide bandwidth (20Hz to 28kHz)
- High noise immunity
- Precision synthesized architecture
- Excellent sensitivity
- Low current consumption
- High 56,000bps data rate
- Direct interface to analog and digital sources
- Wide-range analog capability
- No tuning or external RF components required
- RSSI and power-down lines

Applications

- Wireless Data Transfer
- Wireless Analog / Audio
- Home / Industrial Automation
- Keyless Entry
- Remote Control
- Fire / Security Alarms
- Wireless Networks
- Remote Status Sensing
- Telemetry
- Long-Range RFID
- RS-232 / 485 Data Links
- Voice / Music Links / Intercom

Ordering Information

Ordering Information	
Part Number	Description
TXM-869-ES	ES Series Transmitter 869MHz
TXM-916-ES	ES Series Transmitter 916MHz
RXM-869-ES	ES Series Receiver 869MHz
RXM-916-ES	ES Series Receiver 916MHz
EVAL-***-ES	Basic Evaluation Kit
MDEV-***-ES	Master Development System

*** = Frequency
Receivers are supplied in tubes of 40 pcs.

Figure 2: Ordering Information

Electrical Specifications

ES Series Receiver Specifications						
Parameter	Symbol	Min.	Typ.	Max.	Units	Notes
Power Supply						
Operating Voltage	V_{CC}	4.5	5.0	5.5	VDC	
Supply Current	I_{CC}	5.5	6.0	6.5	mA	
Power-Down Current	I_{PDN}		50.0		μ A	4
Receiver Section						
Receive Frequency	F_C					
RXM-869-ES			869.85		MHz	
RXM-916-ES			916.48		MHz	
Center Frequency Accuracy		-60		+60	kHz	
LO Frequency						
RXM-869-ES			859.15		MHz	
RXM-916-ES			905.78		MHz	
IF Frequency	F_{IF}		10.7		MHz	
Spurious Emissions			-75	-50	dBm	1
Receiver Sensitivity		-92	-97	-102	dBm	2
Noise Bandwidth	N_{3dB}		280		kHz	
Audio Bandwidth		20		28,000	Hz	3,4
Audio Output Level			360		mV _{P-P}	4,5
Data Rate		200		56,000	bps	4

ES Series Receiver Specifications						
Parameter	Symbol	Min.	Typ.	Max.	Units	Notes
Data Output						
Logic Low	V_{OL}		0.0	0.1	VDC	
Logic High	V_{OH}	$V_{CC} - 1.1$	$V_{CC} - 1$	$V_{CC} - 0.9$	VDC	
Power Down Input						
Logic Low	V_{OL}	0.0		0.8	VDC	
Logic High	V_{OH}	2.8		V_{CC}	VDC	
RSSI						
Dynamic Range			60		dB	4
Gain			30		mV/dB	4
Voltage with No Carrier			1.1		V	4
Voltage with No Carrier			2.9		V	4
Antenna Port						
RF Input Impedance	R_{IN}		50		Ω	4
Timing						
Receiver Turn-On Time						
Via V_{CC}		3.8	4.7	5.4	mS	4,6
Max Time Between Transitions		0	5.0		mS	4,7
Environmental						
Operating Temperature Range		0		+70	$^{\circ}$ C	4

1. Into a 50-ohm load.
2. For 10^{-5} BER at 9,600 baud.
3. The audio bandwidth is wide to accommodate the needs of the data slicer. In audio applications, audio quality may be improved by using a low-pass filter rolling off at the maximum frequency of interest.
4. Characterized, but not tested.
5. Input frequency deviation-dependent.
6. Time to receiver readiness from the application of power to V_{CC} or PDN going high.
7. Maximum time without a data transition.

Figure 3: Electrical Specifications

 **Warning:** This product incorporates numerous static-sensitive components. Always wear an ESD wrist strap and observe proper ESD handling procedures when working with this device. Failure to observe this precaution may result in module damage or failure.

Absolute Maximum Ratings

Absolute Maximum Ratings				
Supply Voltage V_{cc}	-0.3	to	+5.5	VDC
Any Input or Output Pin	-0.3	to	$V_{cc} + 0.3$	VDC
Operating Temperature	0	to	+70	°C
Storage Temperature	-40	to	+125	°C
Soldering Temperature	260°C for 15 seconds			

Exceeding any of the limits of this section may lead to permanent damage to the device. Furthermore, extended operation at these maximum ratings may reduce the life of this device.

Figure 4: Absolute Maximum Ratings

Typical Performance Graphs

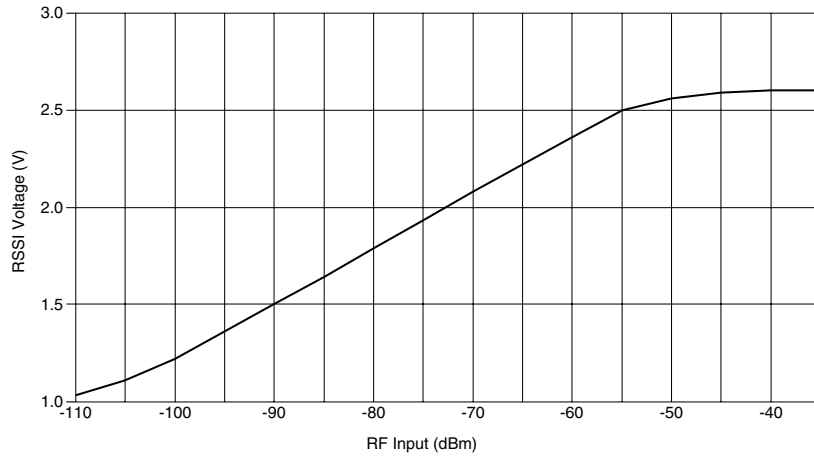

Figure 5: RSSI Characteristics Chart

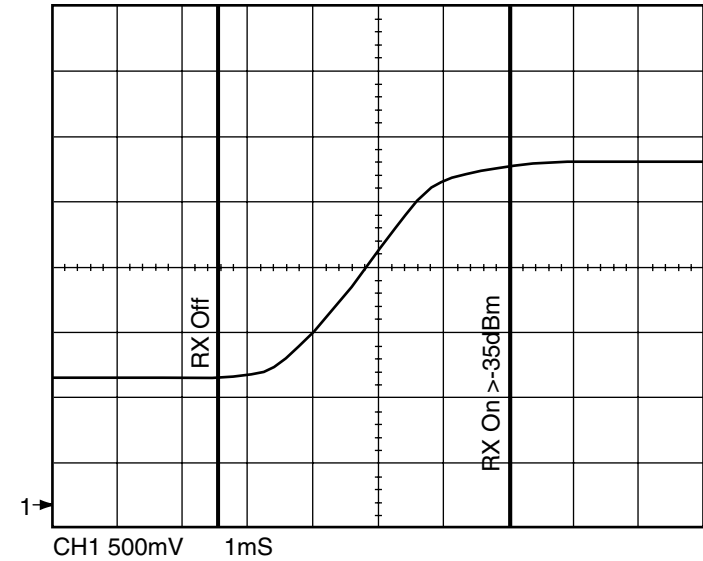

Figure 6: Worst Case RSSI Response Time

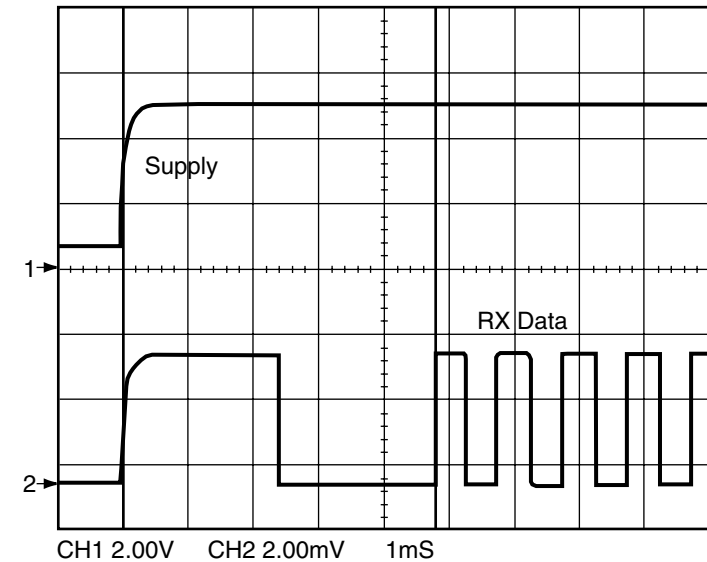

Figure 7: Rx V_{cc} to Valid Data

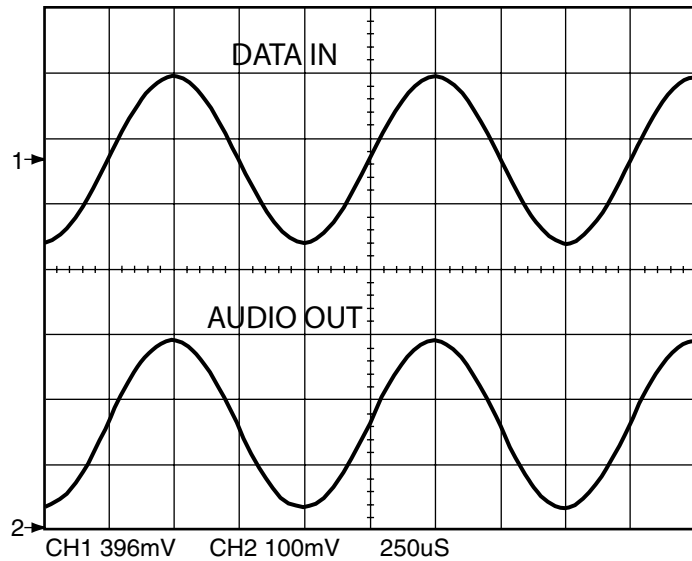

Figure 8: Sine-Wave Modulation Linearity

Pin Assignments

1	ANT	NC	16
2	GND	NC	15
3	NC	PDN	14
4	GND	RSSI	13
5	VCC	DATA	12
6	NC	AUDIO	11
7	NC	A REF	10
8	NC	NC	9

Figure 9: ES Series Receiver Pinout (Top View)

Pin Descriptions

Pin Descriptions			
Pin Number	Name	I/O	Description
1	ANT	—	50-ohm RF Input
2	GND	—	Analog Ground
3	NC	—	No Electrical Connection. Soldered for physical support only.
4	GND	—	Analog Ground
5	V _{CC}	—	Supply Voltage
6–9	NC	—	No Electrical Connection. Soldered for physical support only.
10	A REF	O	Audio RMS (Average) Voltage Reference
11	AUDIO	O	Recovered Analog Output
12	DATA	O	Digital Data Output. This line outputs the demodulated digital data
13	RSSI	O	Received Signal Strength Indicator. This line outputs an analog voltage that is proportional to the strength of the received signal.
14	PDN	I	Power Down. Pulling this line low places the receiver into a low-current state. The module is not able to receive a signal in this state.
15–16	NC	—	No Electrical Connection. Soldered for physical support only.

Figure 10: ES Series Transmitter Pin Descriptions

Module Description

The ES Series receiver module is a single-channel receiver designed for the wireless reception of digital or analog information over distances of up to 1,000 feet outdoors and up to 500 feet indoors. It is based on a high-performance, synthesized, single conversion, superhet architecture. FM / FSK modulation and SAW filtering are utilized to provide performance and noise immunity that are superior to AM-based solutions. The ES series is incredibly compact and cost effective when compared with other FM / FSK devices. Best of all, it is packed with many useful features, offering a great deal of design flexibility.

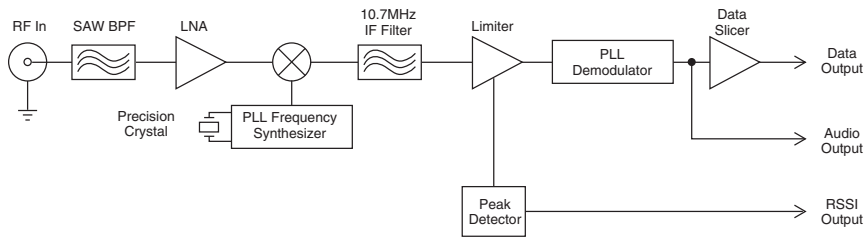

Figure 11: ES Series Receiver Block Diagram

Theory of Operation

The receiver operates in a single conversion superhet configuration, with an IF of 10.7MHz and a baseband analog bandwidth of 28kHz. It is capable of receiving a signal as low as -97dBm (typical). The signal is filtered at the front end by a SAW band-pass filter. The filtered signal is then amplified and downconverted to the 10.7MHz IF by mixing it with a LO frequency generated by a PLL-locked VCO. The 10.7MHz IF is then amplified and filtered. Finally, a PLL demodulator is used to recover the baseband analog signal from the carrier. This analog signal is low-pass filtered and then output on the AUDIO line.

The analog output can be individual frequencies or complex waveforms, such as voice or music. The AUDIO line can also be used to recover unsquared data in instances where a designer wishes to use an external data slicer.

The ES receiver also features a high-performance on-board data slicer for recovery of data transmission. Its output is internally derived from the filtered analog baseband, which is squared and made externally available on the DATA line. The data slicer is capable of recreating squared waveforms from 100Hz to 28kHz, giving a data rate bandwidth of 200bps to 56kbps.

It is important to note that this receiver does not provide hysteresis or squelching of the DATA line. This means that in the absence of a valid transmission or transitional data, the DATA line switches randomly. The effects of this noise must be considered and will be discussed in further detail later in this guide.

The receiver features a Received Signal Strength Indicator (RSSI) output. The RSSI pin outputs a linear voltage relative to the incoming signal level. This output has many valuable uses, including interference assessment, signal strength indication, external data squelching and qualification, and transmitter presence indication. Since RSSI values vary from part to part and correspond to signal strength and not necessarily distance, it is not recommended for range-finding applications.

Using the PDN Line

The Power Down (PDN) line can be used to power down the receiver without the need for an external switch. This line has an internal pull-up, so when it is held high or simply left floating, the module is active.

When the PDN line is pulled to ground, the receiver enters into a low-current ($<50\mu\text{A}$) power-down mode. During this time the receiver is off and cannot perform any function. It may be useful to note that the startup time coming out of power-down is slightly less than when applying V_{CC} .

The PDN line allows easy control of the receiver state from external components, like a microcontroller. By periodically activating the receiver, checking for data, then powering down, the receiver's average current consumption can be greatly reduced, saving power in battery-operated applications.

ESD Concerns

The module has basic ESD protection built in, but in cases where the antenna connection is exposed to the user it is a good idea to add additional protection. A Transient Voltage Suppressor (TVS) diode, varistor or similar component can be added to the antenna line. These should have low capacitance and be designed for use on antennas. Protection on the supply line is a good idea in designs that have a user-accessible power port.

Using the RSSI Line

The receiver's Received Signal Strength Indicator (RSSI) line serves a variety of uses. The RSSI line has a dynamic range of 60dB (typical) and outputs a voltage proportional to the incoming signal strength. A graph of the RSSI line's characteristics appears in the Typical Performance Graphs section. The RSSI levels and dynamic range vary slightly from part to part. It is important to remember that the RSSI output indicates the strength of any in-band RF energy and not necessarily just that from the intended transmitter; therefore, it should only be used to qualify the level and presence of a signal.

The RSSI output can be used to create external squelch circuits. It can be utilized during testing or even as a product feature to assess interference and channel quality by looking at the voltage level with all intended transmitters off. The RSSI output can also be used in direction-finding applications although there are many potential perils to consider in such systems. Finally, it can be used to save system power by "waking up" external circuitry when a transmission is received or crosses a certain threshold. The RSSI output feature adds tremendous versatility for the creative designer.

Using the ES Series Receiver for Analog Applications

The ES Series is an excellent choice for sending a wide range of analog information, including audio. The ability of the ES to receive combinations of analog and digital signals also opens new areas of opportunity for creative product design.

The AUDIO line should be buffered and filtered to obtain maximum signal quality. This is particularly important because the audio output is AC-coupled and any DC loading causes errors in the data slicer since data is derived from the audio voltage. For voice, a 3–4kHz low-pass filter is often employed. For broader-range sources, such as music, a 12–20kHz cutoff is more appropriate. When only sending audio, the DATA line should be pulled to V_{CC} to reduce noise resulting from the data slicer switching.

The Signal-to-Noise Ratio (SNR) of the audio depends on the bandwidth selected. The higher the SNR, the less hiss there is in the background. For the best SNR, choose the lowest filter cutoff appropriate for the intended signal. For applications that require true high fidelity, audio RF links designed expressly for this purpose may prove to be a more appropriate solution; however, a compandor may also be used with the ES Series

transmitter to provide further SNR improvements.

The $360\text{mV}_{\text{P-P}}$ output level of the AUDIO line is not sufficient to drive a speaker, so an amplifier is required. This amplifier can also be used to provide the buffering and filtering described above. Some manufacturers make amplifiers specifically for audio applications, but standard filter designs, such as Butterworth or Sallen-Key, can also be used.

To avoid audible white noise or hiss when no transmission is present, a squelch circuit can be implemented to provide muting. This is easily accomplished with a circuit like the one shown in Figure 12.

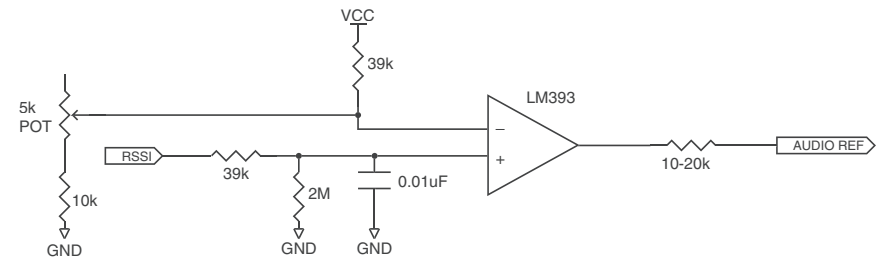

Figure 12: ES Series Receiver Squelch Circuit

Squelching is implemented by comparing the RSSI voltage to a voltage reference (typically a voltage divider) with an open collector-style comparator. When the RSSI voltage becomes lower than the voltage reference, the comparator output is pulled to ground, disabling the AUDIO output. This is useful because the analog circuit can be disabled either when the receiver is out of range or the transmitter is turned off. Of course it is the designer's responsibility to choose a squelch topology that best fits the specific needs of the product.

Using the ES for Digital Applications

As previously discussed, it is important to note that this receiver does not provide hysteresis or squelching of the DATA line. This means that in the absence of a valid transmission or transitional data, the DATA line switches randomly. In many applications this hash is ignored by the decoder or system software, but, depending on your application, it may be useful to add an external circuit to provide data squelching and hysteresis.

A squelch circuit disables the DATA output when the RSSI voltage falls below a reference level. Hysteresis makes the RSSI voltage have to fall lower than the reference voltage before switching off, and to have to rise

higher than the reference voltage before switching on. This prevents low amplitude noise from causing the data line to oscillate. Strong signals can still get through, so it is a good idea to have a noise tolerant protocol.

Creating a circuit that has additional hysteresis characteristics is very basic and requires very few parts thanks to the A REF line. All you need are a couple resistors to provide some isolation for the AUDIO and A REF lines, a large feedback resistor, a pull-up resistor, and an open collector comparator.

The RSSI and A REF lines allow a wide variety of squelch circuits to be implemented. One such possibility is the circuit in Figure 13, which is used on the ES Series Master Development System, and may be employed for audio or data squelching. It is ultimately the responsibility of the designer to determine what, if any, circuit would be most appropriate for the needs of the product.

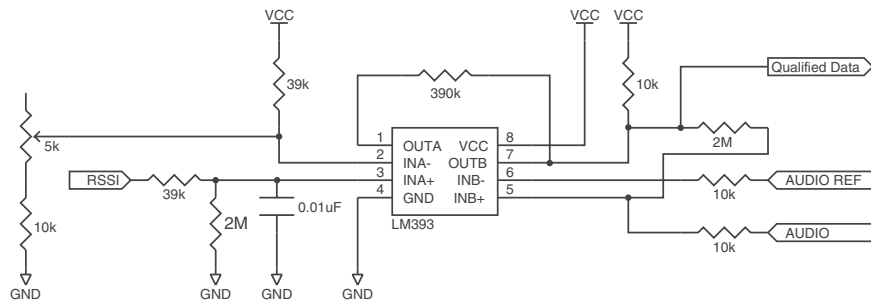

Figure 13: ES Series Receiver Squelch / Hysteresis Circuit

Data squelching in the circuit above is accomplished by comparing the RSSI voltage to a voltage reference (typically a voltage divider) with an open collector style comparator. When the voltage from the RSSI becomes lower than the voltage reference, the comparator output is pulled to GND. This is useful because this output can be used to disable the data-slicer circuit either when the receiver is out of range or the transmitter is turned off.

The squelch threshold is normally set as low as possible to ensure maximum sensitivity and range. It is important to recognize that in many actual use environments, ambient noise and interference may enter the receiver at levels well above the squelch threshold. For this reason, it is always recommended that the product's protocol be structured to allow for the possibility of hashing even when an external squelch circuit is employed.

Power Supply Requirements

The module does not have an internal voltage regulator; therefore it requires a clean, well-regulated power source. While it is preferable to power the unit from a battery, it can also be operated from a power supply as long as noise is less than 20mV. Power supply noise can affect the transmitter modulation; therefore, providing a clean power supply for the module should be a high priority during design.

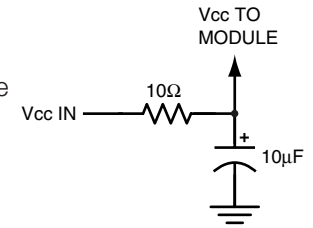

Figure 14: Supply Filter

A 10Ω resistor in series with the supply followed by a 10µF tantalum capacitor from V_{CC} to ground will help in cases where the quality of the supply is poor. Note that the values may need to be adjusted depending on the noise present on the supply line.

Protocol Guidelines

While many RF solutions impose data formatting and balancing requirements, Linx RF modules do not encode or packetize the signal content in any manner. The received signal will be affected by such factors as noise, edge jitter, and interference, but it is not purposefully manipulated or altered by the modules. This gives the designer tremendous flexibility for protocol design and interface.

Despite this transparency and ease of use, it must be recognized that there are distinct differences between a wired and a wireless environment. Issues such as interference and contention must be understood and allowed for in the design process. To learn more about protocol considerations, we suggest you read Linx Application Note AN-00160.

Errors from interference or changing signal conditions can cause corruption of the data packet, so it is generally wise to structure the data being sent into small packets. This allows errors to be managed without affecting large amounts of data. A simple checksum or CRC could be used for basic error detection. Once an error is detected, the protocol designer may wish to simply discard the corrupt data or implement a more sophisticated scheme to correct it.

Interference Considerations

The RF spectrum is crowded and the potential for conflict with unwanted sources of RF is very real. While all RF products are at risk from interference, its effects can be minimized by better understanding its characteristics.

Interference may come from internal or external sources. The first step is to eliminate interference from noise sources on the board. This means paying careful attention to layout, grounding, filtering and bypassing in order to eliminate all radiated and conducted interference paths. For many products, this is straightforward; however, products containing components such as switching power supplies, motors, crystals and other potential sources of noise must be approached with care. Comparing your own design with a Linx evaluation board can help to determine if and at what level design-specific interference is present.

External interference can manifest itself in a variety of ways. Low-level interference produces noise and hashing on the output and reduces the link's overall range.

High-level interference is caused by nearby products sharing the same frequency or from near-band high-power devices. It can even come from your own products if more than one transmitter is active in the same area. It is important to remember that only one transmitter at a time can occupy a frequency, regardless of the coding of the transmitted signal. This type of interference is less common than those mentioned previously, but in severe cases it can prevent all useful function of the affected device.

Although technically not interference, multipath is also a factor to be understood. Multipath is a term used to refer to the signal cancellation effects that occur when RF waves arrive at the receiver in different phase relationships. This effect is a particularly significant factor in interior environments where objects provide many different signal reflection paths. Multipath cancellation results in lowered signal levels at the receiver and shorter useful distances for the link.

Pad Layout

The pad layout diagram in Figure 15 is designed to facilitate both hand and automated assembly.

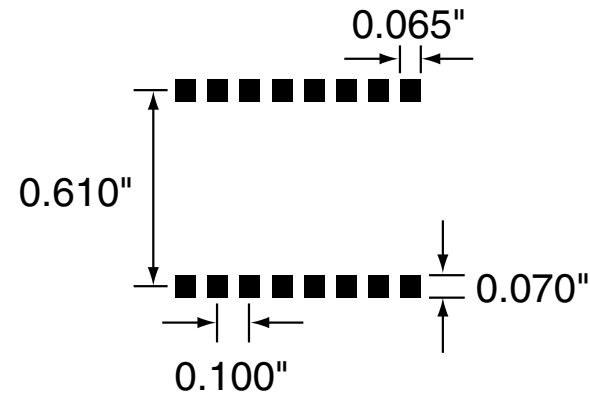

Figure 15: Recommended PCB Layout

Board Layout Guidelines

The module's design makes integration straightforward; however, it is still critical to exercise care in PCB layout. Failure to observe good layout techniques can result in a significant degradation of the module's performance. A primary layout goal is to maintain a characteristic 50-ohm impedance throughout the path from the antenna to the module. Grounding, filtering, decoupling, routing and PCB stack-up are also important considerations for any RF design. The following section provides some basic design guidelines.

During prototyping, the module should be soldered to a properly laid-out circuit board. The use of prototyping or "perf" boards results in poor performance and is strongly discouraged. Likewise, the use of sockets can have a negative impact on the performance of the module and is discouraged.

The module should, as much as reasonably possible, be isolated from other components on your PCB, especially high-frequency circuitry such as crystal oscillators, switching power supplies, and high-speed bus lines.

When possible, separate RF and digital circuits into different PCB regions.

Make sure internal wiring is routed away from the module and antenna and is secured to prevent displacement.

Do not route PCB traces directly under the module. There should not be any copper or traces under the module on the same layer as the module, just bare PCB. The underside of the module has traces and vias that could short or couple to traces on the product's circuit board.

The Pad Layout section shows a typical PCB footprint for the module. A ground plane (as large and uninterrupted as possible) should be placed on a lower layer of your PCB opposite the module. This plane is essential for creating a low impedance return for ground and consistent stripline performance.

Use care in routing the RF trace between the module and the antenna or connector. Keep the trace as short as possible. Do not pass it under the module or any other component. Do not route the antenna trace on multiple PCB layers as vias add inductance. Vias are acceptable for tying together ground layers and component grounds and should be used in multiples.

Each of the module's ground pins should have short traces tying immediately to the ground plane through a via.

Bypass caps should be low ESR ceramic types and located directly adjacent to the pin they are serving.

A 50-ohm coax should be used for connection to an external antenna. A 50-ohm transmission line, such as a microstrip, stripline or coplanar waveguide should be used for routing RF on the PCB. The Microstrip Details section provides additional information.

In some instances, a designer may wish to encapsulate or "pot" the product. There are a wide variety of potting compounds with varying dielectric properties. Since such compounds can considerably impact RF performance and the ability to rework or service the product, it is the responsibility of the designer to evaluate and qualify the impact and suitability of such materials.

Microstrip Details

A transmission line is a medium whereby RF energy is transferred from one place to another with minimal loss. This is a critical factor, especially in high-frequency products like Linx RF modules, because the trace leading to the module's antenna can effectively contribute to the length of the antenna, changing its resonant bandwidth. In order to minimize loss and detuning, some form of transmission line between the antenna and the module should be used unless the antenna can be placed very close (<1/8in) to the module. One common form of transmission line is a coax cable and another is the microstrip. This term refers to a PCB trace running over a ground plane that is designed to serve as a transmission line between the module and the antenna. The width is based on the desired characteristic impedance of the line, the thickness of the PCB and the dielectric constant of the board material. For standard 0.062in thick FR-4 board material, the trace width would be 111 mils. The correct trace width can be calculated for other widths and materials using the information in Figure 16 and examples are provided in Figure 17. Software for calculating microstrip lines is also available on the Linx website.

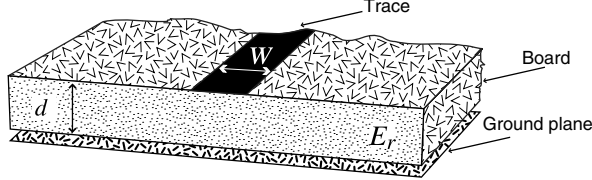

$$E_e = \frac{E_r + 1}{2} + \frac{E_r - 1}{2} \cdot \frac{1}{\sqrt{1 + 12d/W}}$$

$$Z_0 = \begin{cases} \frac{60}{\sqrt{E_e}} \cdot \ln\left(\frac{8d}{W} + \frac{W}{4d}\right) & \text{For } \frac{W}{d} \leq 1 \\ \frac{120\pi}{\sqrt{E_e} \cdot \left(\frac{W}{d} + 1.393 + 0.667 \cdot \ln\left(\frac{W}{d} + 1.444\right)\right)} & \text{For } \frac{W}{d} \geq 1 \end{cases}$$

E_r = Dielectric constant of PCB material

Figure 16: Microstrip Formulas

Example Microstrip Calculations			
Dielectric Constant	Width / Height Ratio (W / d)	Effective Dielectric Constant	Characteristic Impedance (Ω)
4.80	1.8	3.59	50.0
4.00	2.0	3.07	51.0
2.55	3.0	2.12	48.8

Figure 17: Example Microstrip Calculations

Production Guidelines

The module is housed in a hybrid SMD package that supports hand and automated assembly techniques. Since the modules contain discrete components internally, the assembly procedures are critical to ensuring the reliable function of the modules. The following procedures should be reviewed with and practiced by all assembly personnel.

Hand Assembly

Pads located on the bottom of the module are the primary mounting surface (Figure 18). Since these pads are inaccessible during mounting, castellations that run up the side of the module have been provided to facilitate solder wicking to the module's underside. This allows for very

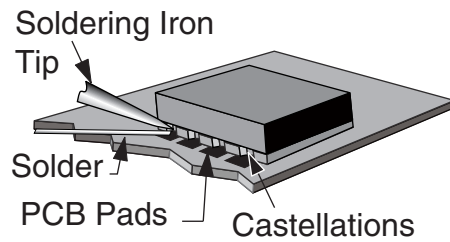

Figure 18: Soldering Technique

quick hand soldering for prototyping and small volume production. If the recommended pad guidelines have been followed, the pads will protrude slightly past the edge of the module. Use a fine soldering tip to heat the board pad and the castellation, then introduce solder to the pad at the module's edge. The solder will wick underneath the module, providing reliable attachment. Tack one module corner first and then work around the device, taking care not to exceed the times in Figure 19.

Warning: Pay attention to the absolute maximum solder times.

Absolute Maximum Solder Times

Hand Solder Temperature: +225°C for 10 seconds

Recommended Solder Melting Point: +180°C

Reflow Oven: +255°C max (see Figure 20)

Figure 19: Absolute Maximum Solder Times

Automated Assembly

For high-volume assembly, the modules are generally auto-placed. The modules have been designed to maintain compatibility with reflow processing techniques; however, due to their hybrid nature, certain aspects of the assembly process are far more critical than for other component types. Following are brief discussions of the three primary areas where caution must be observed.

Reflow Temperature Profile

The single most critical stage in the automated assembly process is the reflow stage. The reflow profile in Figure 20 should not be exceeded because excessive temperatures or transport times during reflow will irreparably damage the modules. Assembly personnel need to pay careful attention to the oven's profile to ensure that it meets the requirements necessary to successfully reflow all components while still remaining within the limits mandated by the modules. The figure below shows the recommended reflow oven profile for the modules.

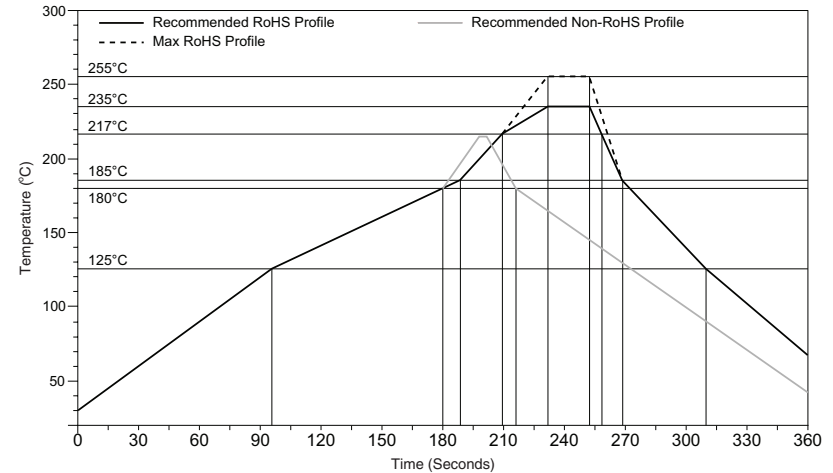

Figure 20: Maximum Reflow Temperature Profile

Shock During Reflow Transport

Since some internal module components may reflow along with the components placed on the board being assembled, it is imperative that the modules not be subjected to shock or vibration during the time solder is liquid. Should a shock be applied, some internal components could be lifted from their pads, causing the module to not function properly.

Washability

The modules are wash-resistant, but are not hermetically sealed. Linx recommends wash-free manufacturing; however, the modules can be subjected to a wash cycle provided that a drying time is allowed prior to applying electrical power to the modules. The drying time should be sufficient to allow any moisture that may have migrated into the module to evaporate, thus eliminating the potential for shorting damage during power-up or testing. If the wash contains contaminants, the performance may be adversely affected, even after drying.

Helpful Application Notes From Linx

It is not the intention of this manual to address in depth many of the issues that should be considered to ensure that the modules function correctly and deliver the maximum possible performance. As you proceed with your design, you may wish to obtain one or more of the following application notes which address in depth key areas of RF design and application of Linx products. These application notes are available online at www.linxtechnologies.com or by contacting Linx.

Helpful Application Note Titles	
Note Number	Note Title
AN-00100	RF 101: Information for the RF Challenged
AN-00126	Considerations for Operation Within the 902–928MHz Band
AN-00130	Modulation Techniques for Low-Cost RF Data Links
AN-00140	The FCC Road: Part 15 from Concept to Approval
AN-00160	Considerations for Sending Data over a Wireless Link
AN-00500	Antennas: Design, Application, Performance

Figure 21: Helpful Application Note Titles

Antenna Considerations

The choice of antennas is a critical and often overlooked design consideration. The range, performance, and legality of an RF link are critically dependent upon the antenna. While adequate antenna performance can often be obtained by trial and error methods, antenna design and matching is a complex task. A professionally designed antenna, such as those from Linx, will help ensure maximum performance and FCC compliance.



Figure 22: Linx Antennas

Linx transmitter modules typically have an output power that is slightly higher than the legal limits. This allows the designer to use an inefficient antenna, such as a loop trace or helical, to meet size, cost, or cosmetic requirements and still achieve full legal output power for maximum range. If an efficient antenna is used, then some attenuation of the output power will likely be needed. This can easily be accomplished by using the LADJ line or a T-pad attenuator. For more details on T-pad attenuator design, please see Application Note AN-00150.

A receiver antenna should be optimized for the frequency or band in which the receiver operates and to minimize the reception of off-frequency signals. The efficiency of the receiver's antenna is critical to maximizing range performance. Unlike the transmitter antenna, where legal operation may mandate attenuation or a reduction in antenna efficiency, the receiver's antenna should be optimized as much as is practical.

It is usually best to utilize a basic quarter-wave whip until your prototype product is operating satisfactorily. Other antennas can then be evaluated based on the cost, size, and cosmetic requirements of the product. You may wish to review Application Note AN-00500 "Antennas: Design, Application, Performance"

General Antenna Rules

The following general rules should help in maximizing antenna performance.

1. Proximity to objects such as a user's hand, body or metal objects will cause an antenna to detune. For this reason, the antenna shaft and tip should be positioned as far away from such objects as possible.
2. Optimum performance is obtained from a $\frac{1}{4}$ - or $\frac{1}{2}$ -wave straight whip mounted at a right angle to the ground plane (Figure 23). In many cases, this isn't desirable for practical or ergonomic reasons, thus, an alternative antenna style such as a helical, loop or patch may be utilized and the corresponding sacrifice in performance accepted.

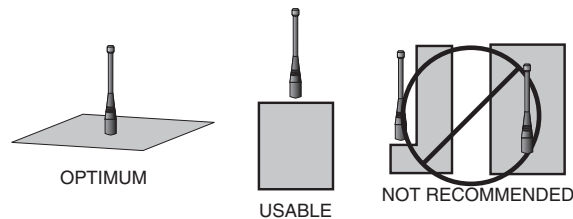

Figure 23: Ground Plane Orientation

3. If an internal antenna is to be used, keep it away from other metal components, particularly large items like transformers, batteries, PCB tracks and ground planes. In many cases, the space around the antenna is as important as the antenna itself. Objects in close proximity to the antenna can cause direct detuning, while those farther away will alter the antenna's symmetry.
4. In many antenna designs, particularly $\frac{1}{4}$ -wave whips, the ground plane acts as a counterpoise, forming, in essence, a $\frac{1}{2}$ -wave dipole (Figure 24). For this reason, adequate ground plane area is essential. The ground plane can be a metal case or ground-fill areas on a circuit board. Ideally, it should have a surface area less than or equal to the overall length of the $\frac{1}{4}$ -wave radiating element. This is often not practical due to size and configuration constraints. In these instances, a designer must make the best use of the area available to create as much ground

VERTICAL $\lambda/4$ GROUNDED ANTENNA (MARCONI)

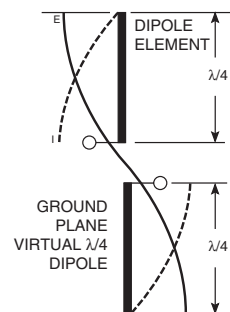

Figure 24: Dipole Antenna

plane as possible in proximity to the base of the antenna. In cases where the antenna is remotely located or the antenna is not in close proximity to a circuit board, ground plane or grounded metal case, a metal plate may be used to maximize the antenna's performance.

5. Remove the antenna as far as possible from potential interference sources. Any frequency of sufficient amplitude to enter the receiver's front end will reduce system range and can even prevent reception entirely. Switching power supplies, oscillators or even relays can also be significant sources of potential interference. The single best weapon against such problems is attention to placement and layout. Filter the module's power supply with a high-frequency bypass capacitor. Place adequate ground plane under potential sources of noise to shunt noise to ground and prevent it from coupling to the RF stage. Shield noisy board areas whenever practical.
6. In some applications, it is advantageous to place the module and antenna away from the main equipment (Figure 25). This can avoid interference problems and allows the antenna to be oriented for optimum performance. Always use 50Ω coax, like RG-174, for the remote feed.

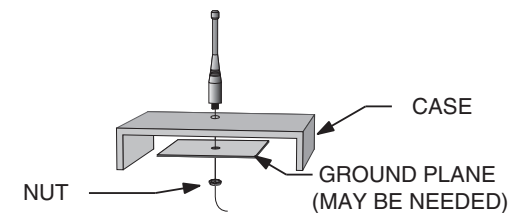

Figure 25: Remote Ground Plane

Common Antenna Styles

There are hundreds of antenna styles and variations that can be employed with Linx RF modules. Following is a brief discussion of the styles most commonly utilized. Additional antenna information can be found in Linx Application Notes AN-00100, AN-00140, AN-00500 and AN-00501. Linx antennas and connectors offer outstanding performance at a low price.

Whip Style

A whip style antenna (Figure 26) provides outstanding overall performance and stability. A low-cost whip can be easily fabricated from a wire or rod, but most designers opt for the consistent performance and cosmetic appeal of a professionally-made model. To meet this need, Linx offers a wide variety of straight and reduced height whip style antennas in permanent and connectorized mounting styles.



Figure 26: Whip Style Antennas

The wavelength of the operational frequency determines an antenna's overall length. Since a full wavelength is often quite long, a partial 1/2- or 1/4-wave antenna is normally employed. Its size and natural radiation resistance make it well matched to Linx modules. The proper length for a straight 1/4-wave can be easily determined using the formula in Figure 27. It is also possible to reduce the overall height of the antenna by using a helical winding. This reduces the antenna's bandwidth but is a great way to minimize the antenna's physical size for compact applications. This also means that the physical appearance is not always an indicator of the antenna's frequency.

$$L = \frac{234}{F_{\text{MHz}}}$$

Figure 27:
L = length in feet of quarter-wave length
F = operating frequency in megahertz

Specialty Styles

Linx offers a wide variety of specialized antenna styles (Figure 28). Many of these styles utilize helical elements to reduce the overall antenna size while maintaining reasonable performance. A helical antenna's bandwidth is often quite narrow and the antenna can detune in proximity to other objects, so care must be exercised in layout and placement.



Figure 28: Specialty Style Antennas

Loop Style

A loop or trace style antenna is normally printed directly on a product's PCB (Figure 29). This makes it the most cost-effective of antenna styles. The element can be made self-resonant or externally resonated with discrete components, but its actual layout is usually product specific. Despite the cost advantages, loop style antennas are generally inefficient and useful only for short range applications. They are also very sensitive to changes in layout and PCB dielectric, which can cause consistency issues during production. In addition, printed styles are difficult to engineer, requiring the use of expensive equipment including a network analyzer. An improperly designed loop will have a high VSWR at the desired frequency which can cause instability in the RF stage.



Figure 29: Loop or Trace Antenna

Linx offers low-cost planar (Figure 30) and chip antennas that mount directly to a product's PCB. These tiny antennas do not require testing and provide excellent performance despite their small size. They offer a preferable alternative to the often problematic "printed" antenna.



Figure 30: SP Series "Splatch" and uSP "MicroSplatch" Antennas

Regulatory Considerations

Note: Linx RF modules are designed as component devices that require external components to function. The purchaser understands that additional approvals may be required prior to the sale or operation of the device, and agrees to utilize the component in keeping with all laws governing its use in the country of operation.

When working with RF, a clear distinction must be made between what is technically possible and what is legally acceptable in the country where operation is intended. Many manufacturers have avoided incorporating RF into their products as a result of uncertainty and even fear of the approval and certification process. Here at Linx, our desire is not only to expedite the design process, but also to assist you in achieving a clear idea of what is involved in obtaining the necessary approvals to legally market a completed product.

For information about regulatory approval, read AN-00142 on the Linx website or call Linx. Linx designs products with worldwide regulatory approval in mind.

In the United States, the approval process is actually quite straightforward. The regulations governing RF devices and the enforcement of them are the responsibility of the Federal Communications Commission (FCC). The regulations are contained in Title 47 of the United States Code of Federal Regulations (CFR). Title 47 is made up of numerous volumes; however, all regulations applicable to this module are contained in Volume 0-19. It is strongly recommended that a copy be obtained from the FCC's website, the Government Printing Office in Washington or from your local government bookstore. Excerpts of applicable sections are included with Linx evaluation kits or may be obtained from the Linx Technologies website, www.linxtechnologies.com. In brief, these rules require that any device that intentionally radiates RF energy be approved, that is, tested for compliance and issued a unique identification number. This is a relatively painless process. Final compliance testing is performed by one of the many independent testing laboratories across the country. Many labs can also provide other certifications that the product may require at the same time, such as UL, CLASS A / B, etc. Once the completed product has passed, an ID number is issued that is to be clearly placed on each product manufactured.

Questions regarding interpretations of the Part 2 and Part 15 rules or the measurement procedures used to test intentional radiators such as Linx RF modules for compliance with the technical standards of Part 15 should be addressed to:

Federal Communications Commission
Equipment Authorization Division
Customer Service Branch, MS 1300F2
7435 Oakland Mills Road
Columbia, MD, US 21046
Phone: + 1 301 725 585 | Fax: + 1 301 344 2050
Email: labinfo@fcc.gov

ETSI Secretaria
650, Route des Lucioles
06921 Sophia-Antipolis Cedex
FRANCE
Phone: +33 (0)4 92 94 42 00
Fax: +33 (0)4 93 65 47 16

International approvals are slightly more complex, although Linx modules are designed to allow all international standards to be met. If the end product is to be exported to other countries, contact Linx to determine the specific suitability of the module to the application.

All Linx modules are designed with the approval process in mind and thus much of the frustration that is typically experienced with a discrete design is eliminated. Approval is still dependent on many factors, such as the choice of antennas, correct use of the frequency selected and physical packaging. While some extra cost and design effort are required to address these issues, the additional usefulness and profitability added to a product by RF makes the effort more than worthwhile.



Linx Technologies
159 Ort Lane
Merlin, OR, US 97532

3090 Sterling Circle Suite 200
Boulder, CO 80301

Phone: +1 541 471 6256
Fax: +1 541 471 6251

www.linxtechnologies.com

Disclaimer

Linx Technologies is continually striving to improve the quality and function of its products. For this reason, we reserve the right to make changes to our products without notice. The information contained in this Data Guide is believed to be accurate as of the time of publication. Specifications are based on representative lot samples. Values may vary from lot-to-lot and are not guaranteed. "Typical" parameters can and do vary over lots and application. Linx Technologies makes no guarantee, warranty, or representation regarding the suitability of any product for use in any specific application. It is the customer's responsibility to verify the suitability of the part for the intended application. **NO LINX PRODUCT IS INTENDED FOR USE IN ANY APPLICATION WHERE THE SAFETY OF LIFE OR PROPERTY IS AT RISK.**

Linx Technologies **DISCLAIMS ALL WARRANTIES OF MERCHANTABILITY AND FITNESS FOR A PARTICULAR PURPOSE. IN NO EVENT SHALL LINX TECHNOLOGIES BE LIABLE FOR ANY OF CUSTOMER'S INCIDENTAL OR CONSEQUENTIAL DAMAGES ARISING IN ANY WAY FROM ANY DEFECTIVE OR NON-CONFORMING PRODUCTS OR FOR ANY OTHER BREACH OF CONTRACT BY LINX TECHNOLOGIES.** The limitations on Linx Technologies' liability are applicable to any and all claims or theories of recovery asserted by Customer, including, without limitation, breach of contract, breach of warranty, strict liability, or negligence. Customer assumes all liability (including, without limitation, liability for injury to person or property, economic loss, or business interruption) for all claims, including claims from third parties, arising from the use of the Products. The Customer will indemnify, defend, protect, and hold harmless Linx Technologies and its officers, employees, subsidiaries, affiliates, distributors, and representatives from and against all claims, damages, actions, suits, proceedings, demands, assessments, adjustments, costs, and expenses incurred by Linx Technologies as a result of or arising from any Products sold by Linx Technologies to Customer. Under no conditions will Linx Technologies be responsible for losses arising from the use or failure of the device in any application, other than the repair, replacement, or refund limited to the original product purchase price. Devices described in this publication may contain proprietary, patented, or copyrighted techniques, components, or materials. Under no circumstances shall any user be conveyed any license or right to the use or ownership of such items.

Mouser Electronics

Authorized Distributor

Click to View Pricing, Inventory, Delivery & Lifecycle Information:

[Linx Technologies:](#)

[RXM-916-ES](#) [TXM-869-ES](#) [RXM-869-ES](#) [TXM-916-ES](#)