

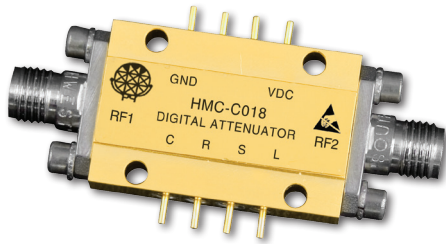

0.5dB LSB GaAs MMIC 6-BIT DIGITAL SERIAL CONTROL ATTENUATOR MODULE, DC - 13 GHz



Features

- 0.5 dB LSB Steps to 31.5 dB
- CMOS Compatible Serial Data Interface
- Typical Bit Error: ± 0.3 dB
- Hermetically Sealed Module
- Field Replaceable SMA Connectors
- 55 °C to +85 °C Operating Temperature

Typical Applications

The HMC-C018 is ideal for:

- Telecom Infrastructure
- Military Radio, Radar & ECM
- Space Systems
- Test Instrumentation

Functional Diagram

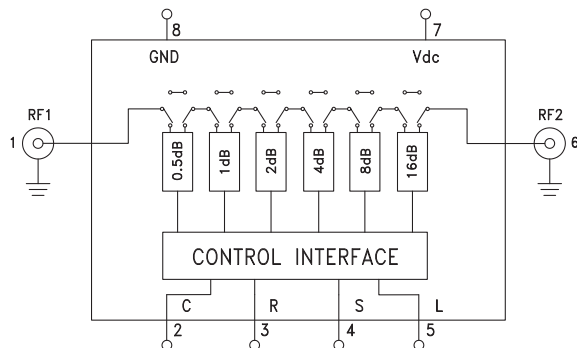

General Description

The HMC-C018 is a DC to 13 GHz 6-bit GaAs IC Digital Serial Control Attenuator housed in a miniature hermetic module. This wideband attenuator features 3.6 dB typical insertion loss, +38 dBm input IP3, and bit values of 0.5 (LSB), 1, 2, 4, 8, and 16 dB for a total attenuation of 31.5 dB. Attenuation accuracy is excellent with ± 0.3 dB typical step error. A six bit CMOS compatible serial control word is used to select each attenuation state and a single Vdc bias of -5V allows operation at frequencies down to DC. Removable SMA connectors can be detached to allow direct connection of the module's I/O pins to a microstrip or coplanar circuit.

Electrical Specifications, $T_A = +25$ °C, with Vdc = -5V and 0/+5V CMOS Control

Parameter	Frequency (GHz)	Min.	Typ.	Max.	Units
Insertion Loss	DC - 4.0 GHz		3.2	3.7	dB
	4.0 - 8.0 GHz		3.6	4.1	dB
	8.0 - 13.0 GHz		5.0	6.0	dB
Attenuation Range	DC - 13.0 GHz		31.5		dB
Return Loss (RF1 & RF2, All Atten. States)	DC - 8.0 GHz		15		dB
	8.0 - 13.0 GHz		10		dB
Attenuation Accuracy: (Referenced to Insertion Loss) All States	DC - 3.0 GHz	$\pm (0.2 + 3\% \text{ of Atten. Setting}) \text{ Max}$			dB
	3.0 - 10.0 GHz	$\pm (0.4 + 3\% \text{ of Atten. Setting}) \text{ Max}$			dB
	3.0 - 10.0 GHz	$\pm (0.5 + 6\% \text{ of Atten. Setting}) \text{ Max}$			dB
	10.0 - 13.0 GHz	$\pm (0.6 + 6\% \text{ of Atten. Setting}) \text{ Max}$			dB
Input Power for 0.1 dB Compression	1.0 - 13.0 GHz		22		dBm
Input Third Order Intercept Point (Two-Tone Input Power= 0 dBm Each Tone)	1.0 - 13.0 GHz	REF State	46		dBm
		All Other States	32		dBm
Switching Characteristics	DC - 13.0 GHz				
tRISE, tFALL (10/90% RF)			600		ns
tON/tOFF (50% CTL to 10/90% RF)			700		ns

For price, delivery, and to place orders, please contact Hittite Microwave Corporation:
 20 Alpha Road Chelmsford, MA 01824 Phone: 978-250-3343 Fax: 978-250-3373
 Order Online at www.hittite.com



0.5dB LSB GaAs MMIC 6-BIT DIGITAL SERIAL CONTROL ATTENUATOR MODULE, DC - 13 GHz

Insertion Loss

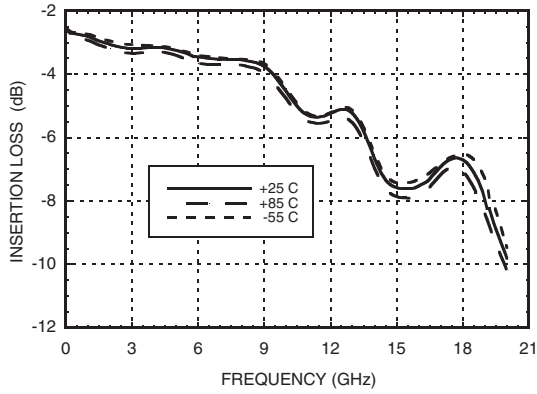

Return Loss RF1, RF2
(Only Major States are Shown)

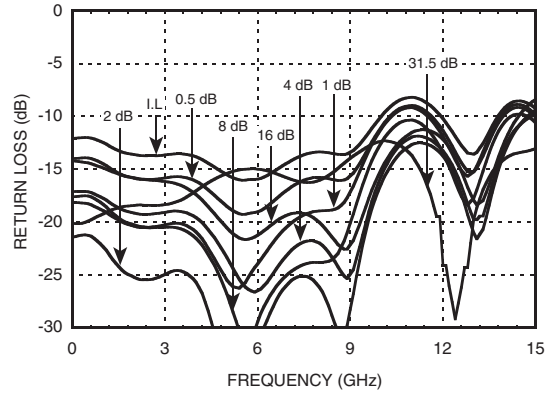

Normalized Attenuation
(Only Major States are Shown)

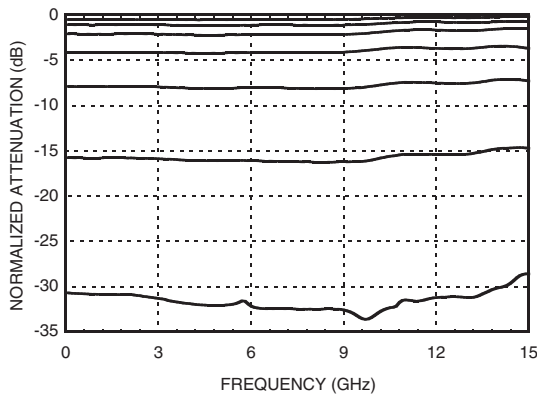

Bit Error vs. Attenuation State

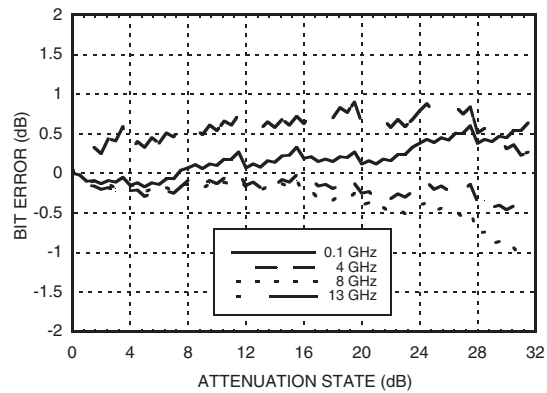

Bit Error vs. Frequency
(Only Major States are Shown)

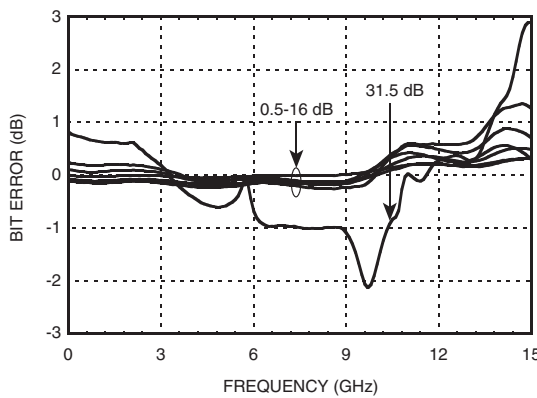

Relative Phase vs. Frequency
(Only Major States are Shown)

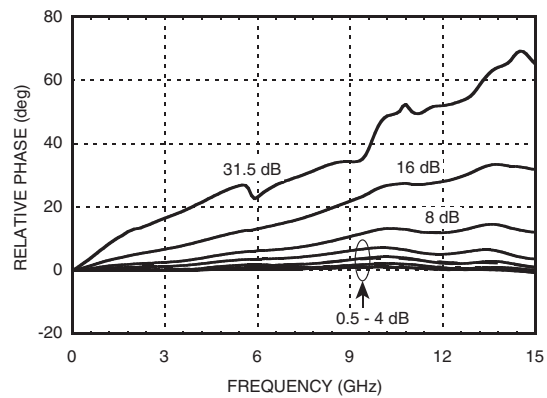



0.5dB LSB GaAs MMIC 6-BIT DIGITAL SERIAL CONTROL ATTENUATOR MODULE, DC - 13 GHz

Worst Case Step Error Between Successive Attenuation States

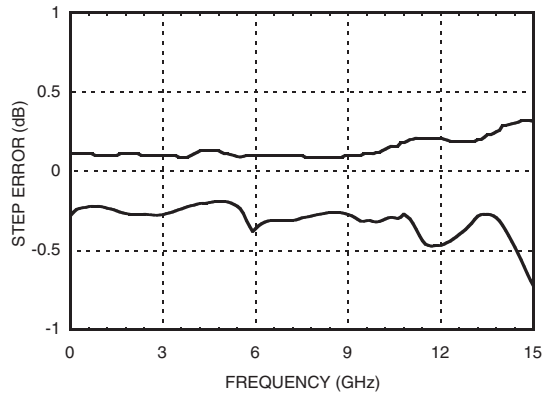

Absolute Maximum Ratings

Digital Inputs (Reset, Shift Clock, Latch Enable & Serial Input)	-0.5V to +5.5V
Bias Voltage (VDC)	-7.0 Vdc
Storage Temperature	-65 to + 150 °C
Operating Temperature	-55 to +85 °C
RF Input Power (0.5 - 13.0 GHz)	+25 dBm



**ELECTROSTATIC SENSITIVE DEVICE
OBSERVE HANDLING PRECAUTIONS**

Bias Voltage & Current

VDC Range= -5.0 Vdc ± 10%		
VDC	Idc (Typ.) (mA)	Idc (Max.) (mA)
-5.0	5	9

CMOS Control Voltages

State	Bias Condition
Low	0 to +1.3V
High	+3.5 to +5.0V

Serial Input Truth Table

Latch Enable	Shift Clock	Reset	Function
X	X	L	Shift register cleared
X	↑	H	Shift register clocked
↑	X	H	Contents of shift register transferred to Digital Attenuator

Truth Table

Serial Control Input						Attenuation Settings RF1 - RF2
C0.5	C1	C2	C4	C8	C16	
H	H	H	H	H	H	Reference I.L.
L	H	H	H	H	H	0.5 dB
H	L	H	H	H	H	1 dB
H	H	L	H	H	H	2 dB
H	H	H	L	H	H	4 dB
H	H	H	H	L	H	8 dB
H	H	H	H	H	L	16 dB
L	L	L	L	L	L	31.5 dB

Any combination of the above states will provide an attenuation approximately equal to the sum of the bits selected.



0.5dB LSB GaAs MMIC 6-BIT DIGITAL SERIAL CONTROL ATTENUATOR MODULE, DC - 13 GHz

Timing

Parameter	Symbol	Min.	Max.	Units
Serial Input Setup Time	ts	20	-	ns
Hold time from Serial Input to Shift Clock	th	0	-	ns
Setup time from Shift Clock to Latch Enable	tisup	40	-	ns
Propagation delay, Latch Enable to C0.5 through C8	tpd	-	30	ns
Setup time from Reset to Shift Clock	-	20	-	ns
Clock Frequency (1/tclk)	fclk	-	30	MHz

Timing Diagram

Serial data is shifted in on the rising edge of the Shift Clock, LSB first, and is latched on the rising edge of Latch Enable.

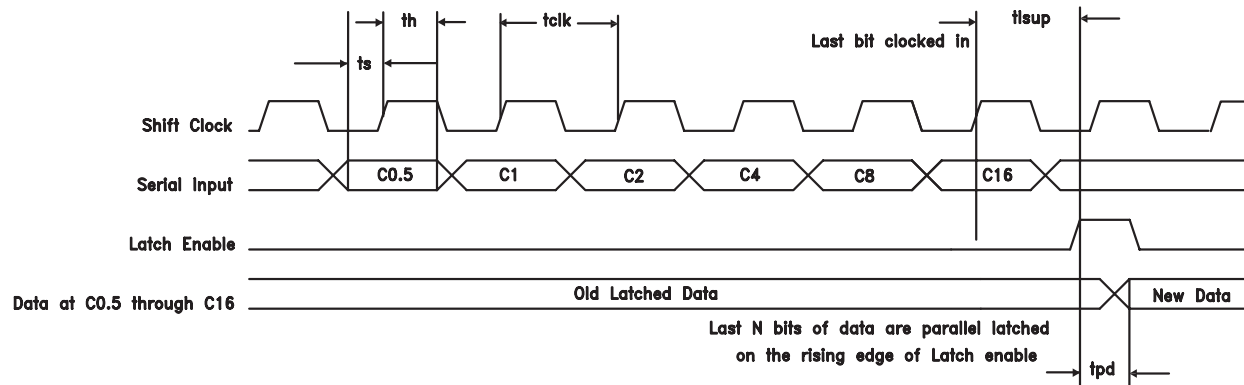



0.5dB LSB GaAs MMIC 6-BIT DIGITAL SERIAL CONTROL ATTENUATOR MODULE, DC - 13 GHz

Logic / Functional Diagram

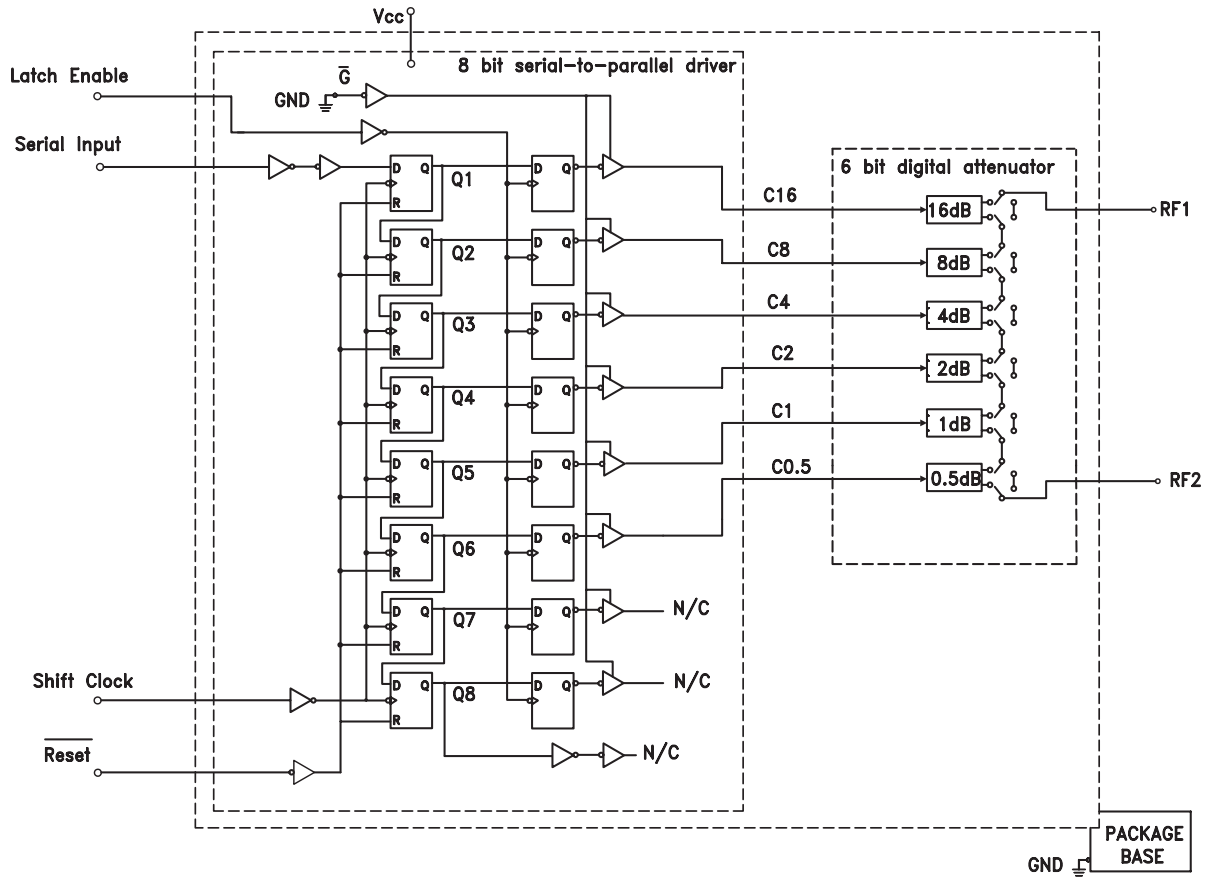



**0.5dB LSB GaAs MMIC 6-BIT DIGITAL
SERIAL CONTROL ATTENUATOR MODULE, DC - 13 GHz**

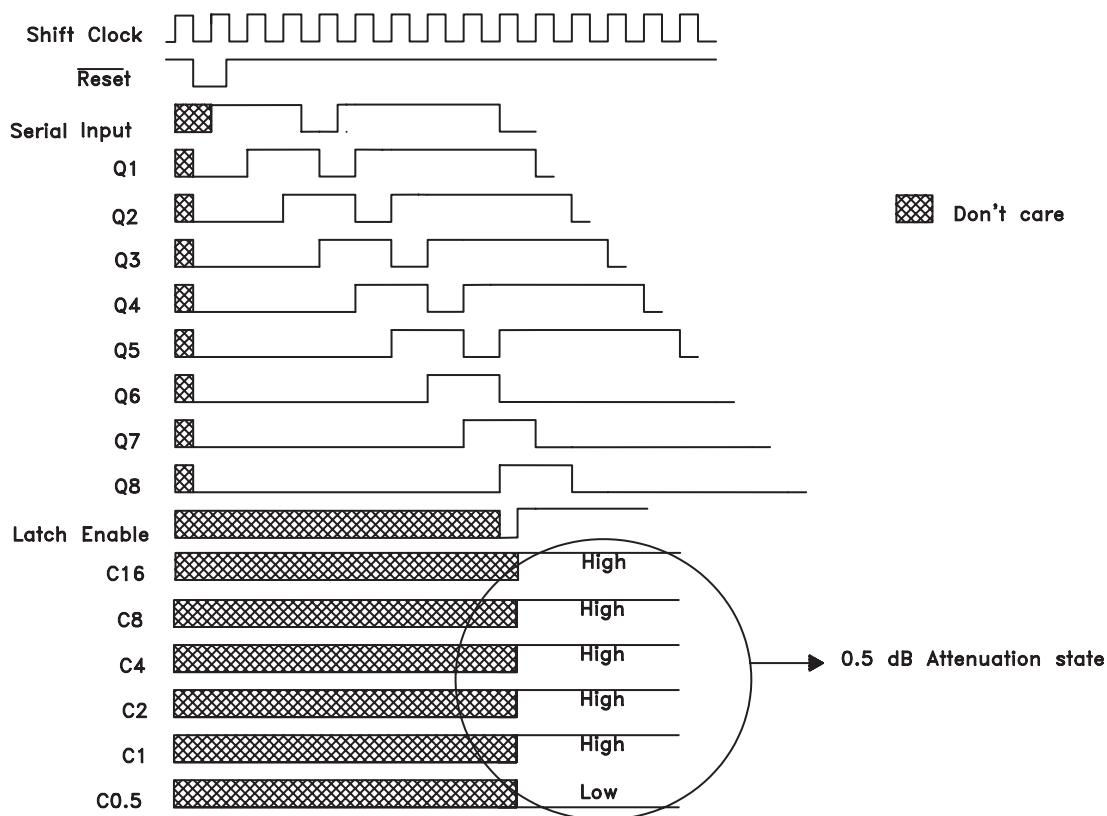

Programming Example to Select 0.5 dB Attenuation State



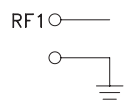
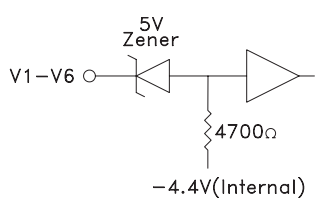
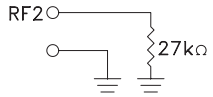
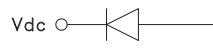

0.5dB LSB GaAs MMIC 6-BIT DIGITAL SERIAL CONTROL ATTENUATOR MODULE, DC - 13 GHz

Pin Description

Pin Number	Function	Description	Interface Schematic
1	RF1	This pin is DC coupled and matched to 50 Ohms. Blocking capacitors are required if RF line potential is not equal to 0 Vdc.	
2	C	Shift Clock	
3	R	Reset	
4	S	Serial Input	
5	L	Latch Enable	
6	RF2	This pin is DC coupled and matched to 50 Ohms. Blocking capacitors are required if RF line potential is not equal to 0 Vdc.	
7	Vdc	Supply voltage: -5 Vdc ±10%. (Internal diode for reverse bias protection)	
8	GND	Power Supply Ground	



0.5dB LSB GaAs MMIC 6-BIT DIGITAL SERIAL CONTROL ATTENUATOR MODULE, DC - 13 GHz

Outline Drawing

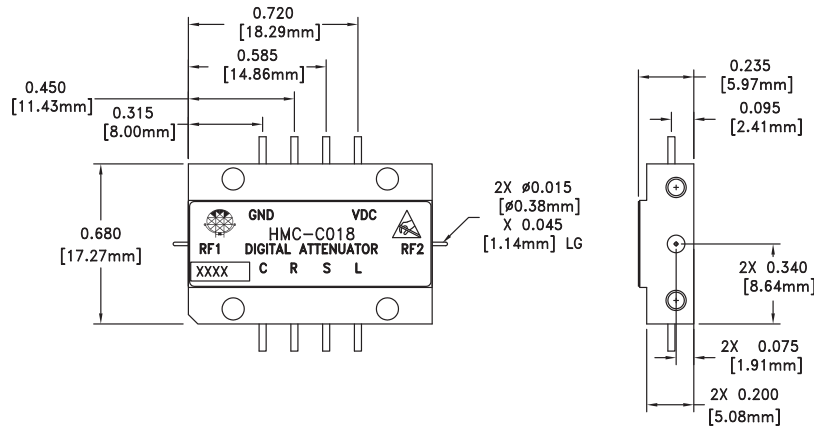
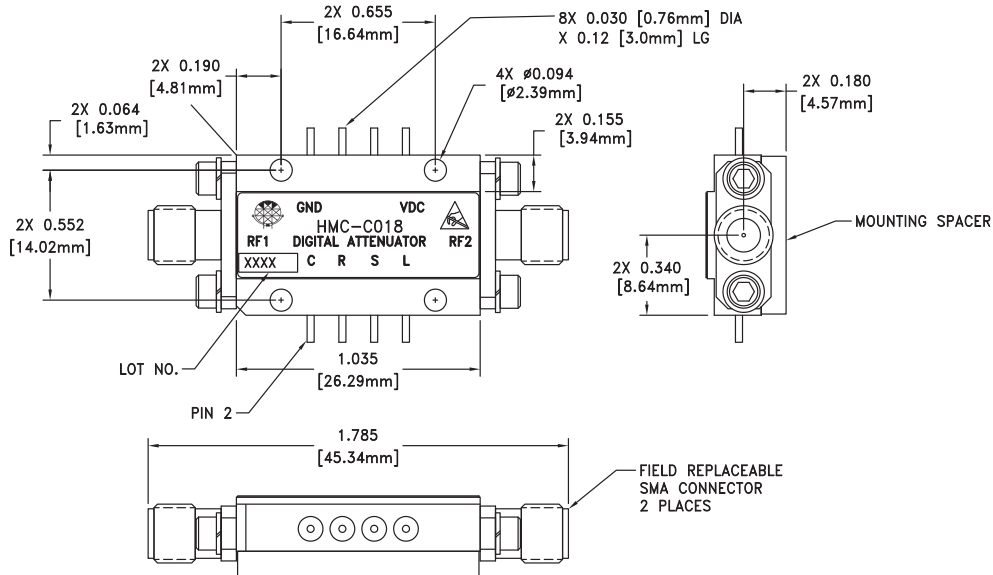

VIEW SHOWN WITH CONNECTORS REMOVED

Package Information

Package Type	C-6
Package Weight [1]	17.4 gms [2]
Spacer Weight	3 gms [2]

[1] Includes the connectors

[2] ±1 gms Tolerance

NOTES:

1. PACKAGE, LEADS, COVER MATERIAL: KOVAR™
2. PLATING: ELECTROLYTIC GOLD 50 MICROINCHES MIN., OVER ELECTROLYTIC NICKEL 75 MICROINCHES MIN
3. MOUNTING SPACER: NICKEL PLATED ALUMINUM
4. ALL DIMENSIONS ARE IN INCHES [MILLIMETERS]
5. TOLERANCES ±0.010 [0.25] UNLESS OTHERWISE SPECIFIED
6. FIELD REPLACEABLE SMA CONNECTORS TENSOLITE 5602 - 5CCSF OR EQUIVALENT
7. TO MOUNT MODULE TO SYSTEM PLATFORM REPLACE 0 -80 HARDWARE WITH DESIRED MOUNTING SCREWS