

Ultra Fast Recovery Rectifier Diodes

... Designed for use in switching power supplies, inverters and as free wheeling diodes. These state-of-the-art devices have the following features:

- * High Surge Capacity
- * Low Power Loss, High efficiency
- * Glass Passivated chip junctions
- * 150 °C Operating Junction Temperature
- * Low Stored Charge Majority Carrier Conduction
- * Low Forward Voltage , High Current Capability
- * High-Switching Speed 50 & 75 Nanosecond Recovery Time
- * Plastic Material used Carries Underwriters Laboratory Flammability Classification 94V-O

**ULTRA FAST
RECTIFIERS**

**8 AMPERES
700 -- 1000 VOLTS**

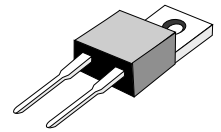

TO-220A

MAXIMUM RATINGS

| Characteristic | Symbol | U08A | | | | Unit |
|--|---------------------------------|---------------|-----|-----|------|------|
| | | 70 | 80 | 90 | 100 | |
| Peak Repetitive Reverse Voltage Working Peak Reverse Voltage DC Blocking Voltage | V_{RRM} V_{RWM} V_R | 700 | 800 | 900 | 1000 | V |
| RMS Reverse Voltage | $V_{R(RMS)}$ | 490 | 560 | 630 | 700 | V |
| Average Rectifier Forward Current | $I_{F(AV)}$ | 8.0 | | | | A |
| Non-Repetitive Peak Surge Current (Surge applied at rate load conditions halfwave, single phase, 60Hz) | I_{FSM} | 125 | | | | A |
| Operating and Storage Junction Temperature Range | T_J, T_{stg} | - 65 to + 150 | | | | °C |

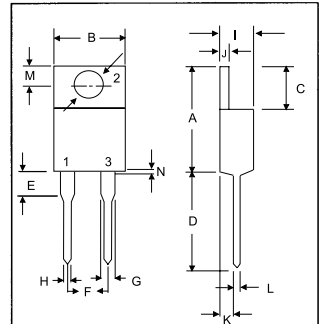

| DIM | MILLIMETERS | |
|-----|-------------|-------|
| | MIN | MAX |
| A | 14.68 | 15.32 |
| B | 9.78 | 10.42 |
| C | 6.01 | 6.52 |
| D | 13.06 | 14.62 |
| E | 3.57 | 4.07 |
| F | 4.83 | 5.33 |
| G | 1.12 | 1.36 |
| H | 0.72 | 0.96 |
| I | 4.22 | 4.98 |
| J | 1.14 | 1.36 |
| K | 2.20 | 2.97 |
| L | 0.33 | 0.55 |
| M | 2.48 | 2.98 |
| N | -- | 1.00 |
| O | 3.70 | 3.90 |

ELECTRICAL CHARACTERISTICS

| Characteristic | Symbol | U08A | | | | Unit |
|--|----------|--------------|----|----|-----|------|
| | | 70 | 80 | 90 | 100 | |
| Maximum Instantaneous Forward Voltage ($I_F=8.0$ Amp, $T_C=25$ °C) ($I_F=8.0$ Amp, $T_C=100$ °C) | V_F | 1.75 1.65 | | | | V |
| Maximum Instantaneous Reverse Current (Rated DC Voltage, $T_C=25$ °C) (Rated DC Voltage, $T_C=100$ °C) | I_R | 10 500 | | | | uA |
| Reverse Recovery Time ($I_F=0.5$ A, $I_R=1.0$ A, $I_{rr}=0.25$ A) | T_{rr} | 50 | | 75 | | ns |
| Typical Junction Capacitance (Reverse Voltage of 4 volts & $f=1$ MHz) | C_P | 40 | | | | pF |

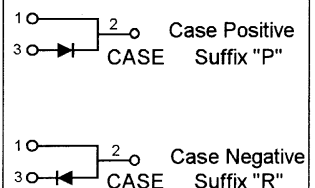

U08A70 Thru U08A100

FIG-1 TYPICAL FORWARD CHARACTERISTICS

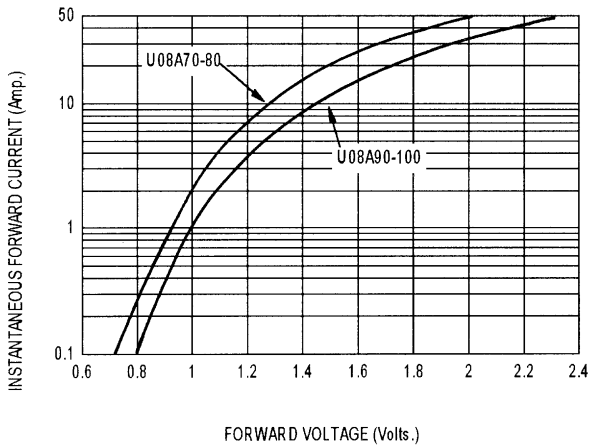

FIG-2 TYPICAL REVERSE CHARACTERISTICS

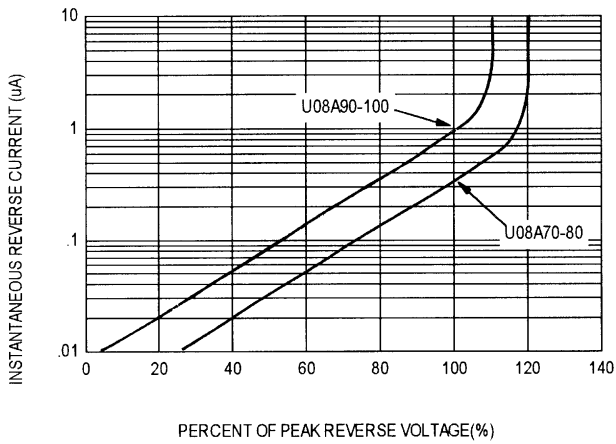

FIG-3 FORWARD CURRENT DERATING CURVE

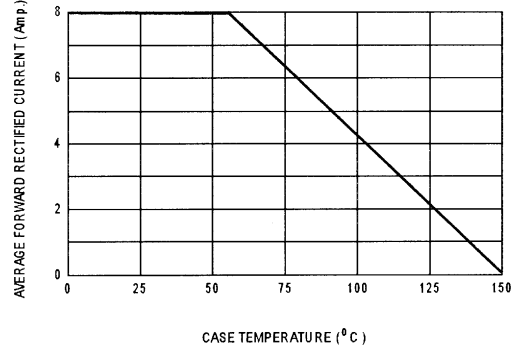

FIG-4 TYPICAL JUNCTION CAPACITANCE

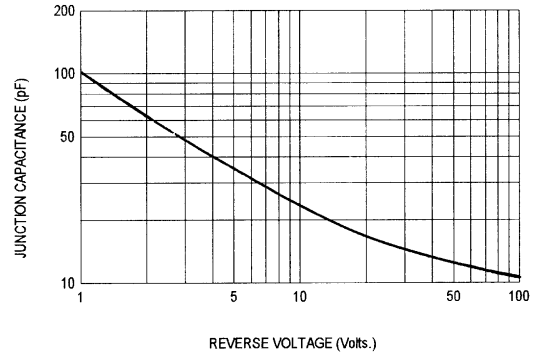
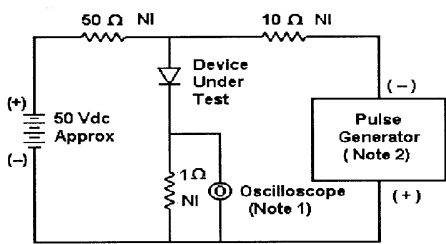
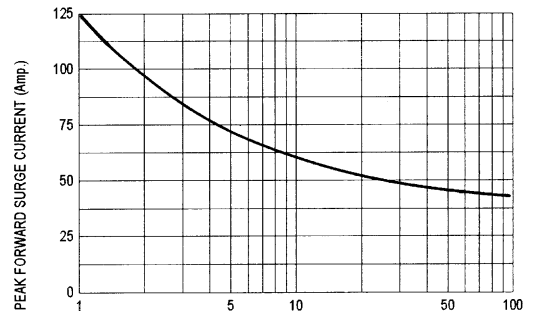
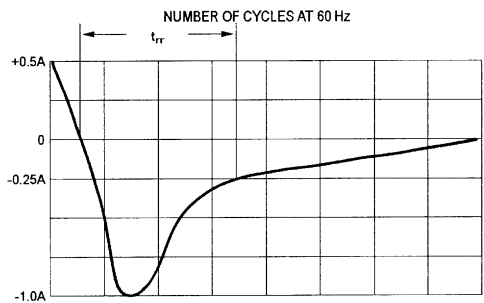

FIG-5 PEAK FORWARD SURGE CURRENT



- Notes:
 1. Rise Time = 7 ns max. Input Impedance = 1 M Ω, 22 pF
 2. Rise Time = 10 ns max. Input Impedance = 50 Ω



Set time base for 10/20 ns/div

Fig-6 Reverse Recovery Time Characteristic and Test Circuit Diagram