

ANSALDO**Ansaldo Trasporti s.p.a.
Unita' Semiconduttori**Via N. Lorenzi 8 - I 16152 GENOVA - ITALY
Tel. int. +39/(0)10 6556549 - (0)10 6556488
Fax Int. +39/(0)10 6442510
Tx 270318 ANSUSE I -**FAST RECOVERY DIODE****ARF526**

Repetitive voltage up to	1600 V
Mean forward current	1345 A
Surge current	20 kA

TARGET SPECIFICATION

feb 97 - ISSUE : 02

Symbol	Characteristic	Conditions	T _j [°C]	Value	Unit
BLOCKING					
V _{RRM}	Repetitive peak reverse voltage		125	1600	V
V _{RSM}	Non-repetitive peak reverse voltage		125	1700	V
I _{RRM}	Repetitive peak reverse current	V=VRRM	125	50	mA
CONDUCTING					
I _{F(AV)}	Mean forward current	180° sin ,50 Hz, Th=55°C, double side cooled		1345	A
I _{F(AV)}	Mean forward current	180° square,50 Hz,Th=55°C,double side cooled		1350	A
I _{FSM}	Surge forward current	Sine wave, 10 ms	125	20	kA
I ² t	I ² t	reapplied reverse voltage up to 50% VRSM		2000 x1E3	A ² s
V _{FM}	Forward voltage	Forward current : 2000 A	125	1.6	V
V _{F(TO)}	Threshold voltage		125	1.00	V
r _F	Forward slope resistance		125	0.300	mohm
SWITCHING					
t _{rr}	Reverse recovery time	I _F = 1000 A di/dt= 100 A/μs VR = 50 V	125	3.5	μs
Q _{rr}	Reverse recovery charge			250	μC
I _{rr}	Peak reverse recovery current			145	A
s	Softness (s-factor), min			0.5	
V _{FR}	Peak forward recovery	di/dt= 100 A/μs	125	15	V
MOUNTING					
R _{th(j-h)}	Thermal impedance	Junction to heatsink, double side cooled		26	°C/kW
T _j	Operating junction temperature			-30 / 125	°C
F	Mounting force			18.0 / 20.0	kN
	Mass			500	g
ORDERING INFORMATION : ARF526 S 16					
standard specification <input type="checkbox"/> <input type="checkbox"/> VRRM/100					

DISSIPATION CHARACTERISTICS

SQUARE WAVE

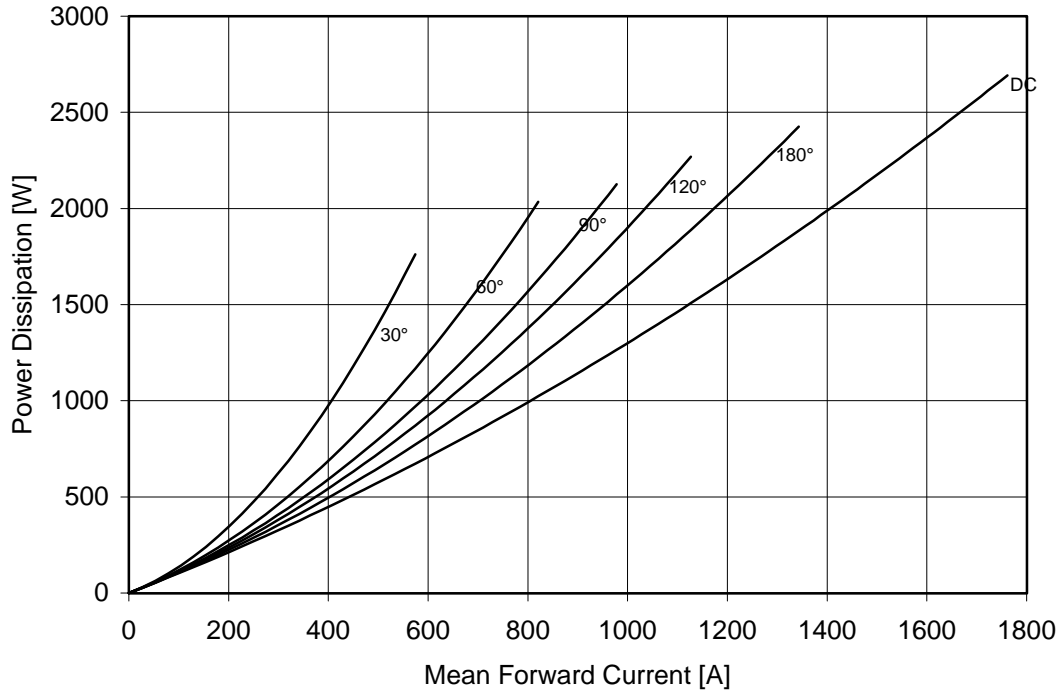

SINE WAVE

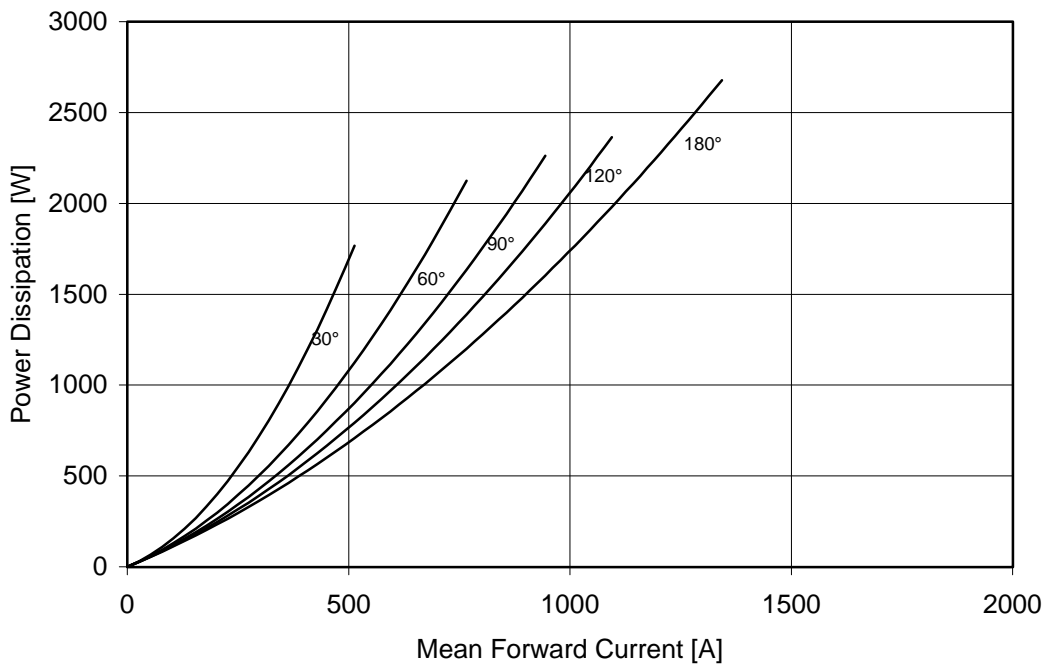

TARGET SPECIFICATION feb 97 - ISSUE : 02

FORWARD CHARACTERISTIC
T_j = 125 °C

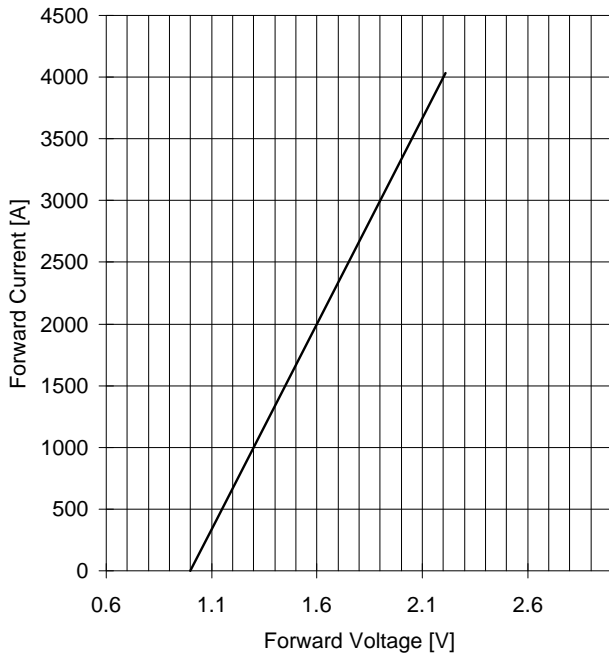

SURGE CHARACTERISTIC
T_j = 125 °C

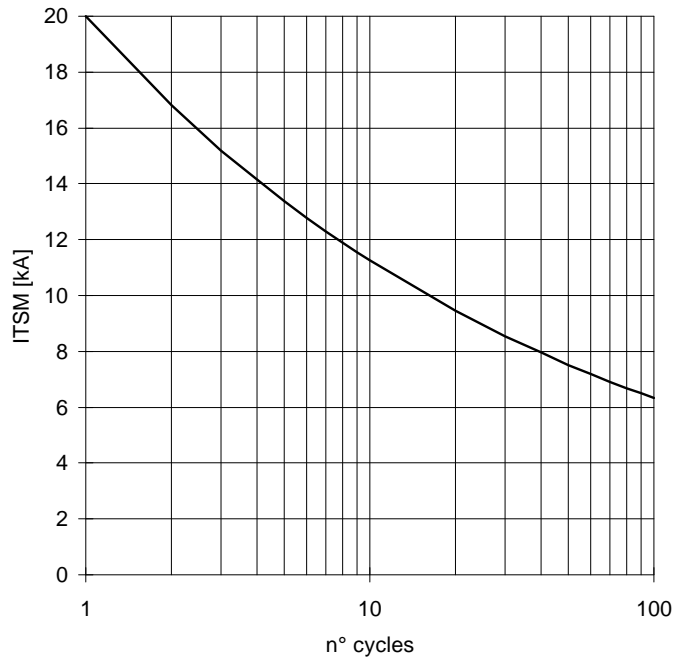

TRANSIENT THERMAL IMPEDANCE
DOUBLE SIDE COOLED

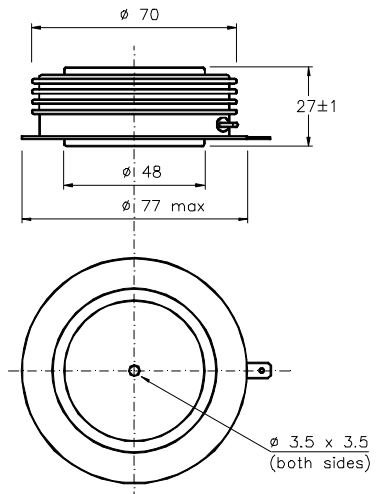
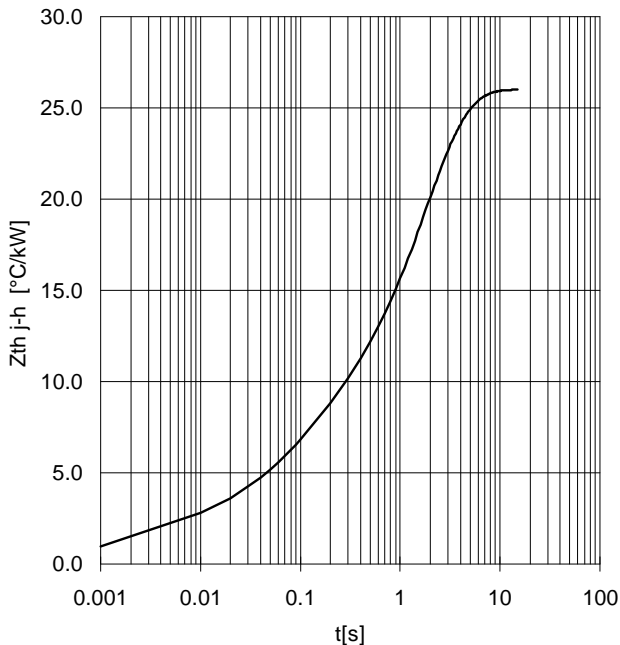

Dimensions
in mm

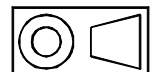

All the characteristics given in this data sheet are guaranteed only with uniform clamping force, cleaned and lubricated heatsink, surfaces with flatness < .03 mm and roughness < 2 μm.

In the interest of product improvement ANSALDO reserves the right to change any data given in this data sheet at any time without previous notice.

If not stated otherwise the maximum value of ratings (symbols over shaded background) and characteristics is reported.

Distributed by

