



600mA LOW DROPOUT LINEAR REGULATOR

Features

- Low Dropout Voltage of 600mV at 600mA
- Guaranteed 600mA Output Current
- Very Low Quiescent Current at about 30uA
- Max. $\pm 2\%$ Output Accuracy
- Needs Only $1\mu\text{F}$ Capacitor for Stability
- Thermal Shutdown Protection
- Current Limit Protection
- Low-ESR Ceramic Capacitor for Output Stability
- RoHS Compliant

Applications

- DVD/CD-ROMs, CD/RWs
- Wireless Devices
- LCD Modules
- Battery Power Systems
- Card Readers
- XDSL Routers

Description

The APE8805 series are low dropout, positive linear regulators with very low quiescent current. The APE8805 can supply 600mA output current with a low dropout voltage at about 600mV.

The APE8805 regulator is able to operate with output capacitors as small as $1\mu\text{F}$ for stability. Other than the current limit protection APE8805 also offers on chip thermal shutdown feature providing protection against overload or any condition when the ambient temperature exceeds the junction temperature.

The APE8805 series are available in fixed output voltage ranging from 1.8 volt, 2.5 volt and 3.3 volt. The APE8805 series are available in space-saving SOT-23, SOT-89, and SOT-223 packages.

Typical Application Circuit

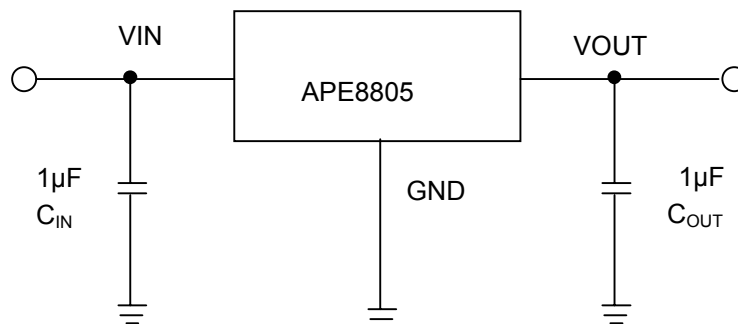
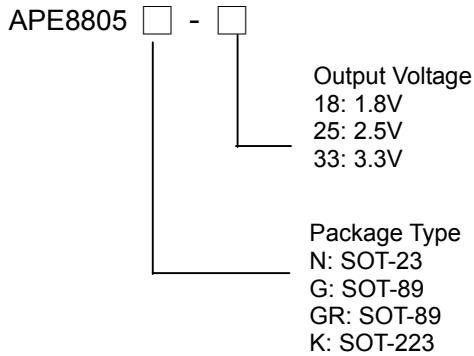

Figure 1. Typical Application Circuit of APE8805

Note : To prevent oscillation, it is recommended to use minimum $1\mu\text{F}$ X7R or X5R dielectric capacitors if ceramics are used as input/output capacitors.



Ordering Information



Note : The devices are available in fixed voltages range of 1.8V , 2.5V& 3.3V. Please consult APEC sales office or authorized distributor for availability of special output voltages.

Pin Assignments

SOT-23(N)

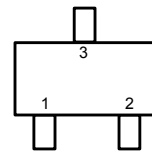

TOP VIEW
1. GND
2. VOUT
3. VIN

SOT-89(G)

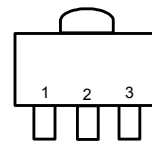

TOP VIEW
1. GND
2. VIN
3. VOUT

SOT-89(GR)

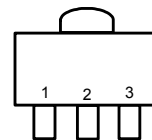

TOP VIEW
1. VOUT
2. GND
3. VIN

SOT-223(K)

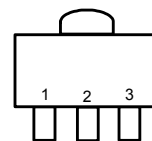

TOP VIEW
1. VOUT
2. GND
3. VIN

Figure 2. Pin Assignment of APE8805

Absolute Maximum Ratings

Parameter	Symbol	Min	Max	Unit
Supply Input Voltage	V_{IN}		6	V
Maximum Junction Temperature	T_J		150	°C
Power Dissipation SOT-23	P_D		0.4	W
Power Dissipation SOT-89	P_D		0.57	W
Power Dissipation SOT-223	P_D		0.74	W
Package Thermal Resistance SOT-23	θ_{JA}		250	°C/W
Package Thermal Resistance SOT-89	θ_{JA}		175	°C/W
Package Thermal Resistance SOT-223	θ_{JA}		135	°C/W
Storage Temperature Range	T_S	-65	150	°C
Lead Temperature (Soldering, 10 sec.)	T_{LEAD}		260	°C

Note : Stresses beyond those listed under "Absolute Maximum Ratings" may cause permanent damage to the device.



Recommended Operating Conditions

Parameter	Symbol	Min	Max	Unit
Input Voltage	V_{IN}	2.8	5.5	V
Operating Junction Temperature Range	T_J	-40	125	°C

Electrical Characteristics

($V_{IN}=V_{OUT}+1V$ or $V_{IN}=2.8V$ whichever is greater, $C_{IN}=1\mu F$, $C_{OUT}=1\mu F$, $T_A=25\text{ }^\circ\text{C}$, unless otherwise specified)

Parameter	Symbol	Conditions	Min	Typ	Max	Unit
Output Voltage Accuracy	ΔV_{OUT}	$I_O = 1\text{mA}$	-2		+2	%
Current Limit	I_{LIMIT}	$R_{Load}=1\Omega$	600			mA
Quiescent Current	I_Q	$I_O = 0\text{mA}$		30	50	μA
Dropout Voltage (Note 1)	V_{DROP}	$1.2V \leq V_{OUT} \leq 2.0V$		1400		mV
		$2.0V < V_{OUT} \leq 2.8V$		800		
		$2.8V < V_{OUT} \leq 4.5V$		600		
Line Regulation	ΔV_{LINE}	$I_O=1\text{mA}$, $V_{IN}=V_{OUT} + 1V$ to 5V		1	5	mV
Load Regulation (Note 2)	ΔV_{LOAD}	$I_O=0\text{mA}$ to 600mA		13	50	mV
Ripple Rejection	PSRR	$V_{IN}=V_{OUT}+1V$ $f_{RIPPLE} = 120\text{Hz}$, $C_{OUT} = 1\mu F$		60		dB
Temperature Coefficient	TC	$I_{OUT} = 1\text{mA}$, $V_{IN} = 5V$		50		ppm/ °C
Thermal Shutdown Temperature	TSD			160		°C
Thermal Shutdown Hysteresis	ΔTSD			25		°C

Note 1 : The dropout voltage is defined as $V_{IN}-V_{OUT}$, which is measured when V_{OUT} drop about 100mV.

Note 2 : Regulation is measured at a constant junction temperature by using 40ms current pulse and load regulation in the load range from 0mA to 600mA.

Functional Pin Description

Pin Name	Pin Function
VIN	Power is supplied to this device from this pin which is required an input filter capacitor. In general, the input capacitor in the range of 1 μ F to 10 μ F is sufficient.
VOUT	The output supplies power to loads. The output capacitor is required to prevent output voltage unstable. The APE8805 is stable with an output capacitor 1 μ F or greater. The larger output capacitor will be required for application with large transit load to limit peak voltage transits, besides could reduce output noise, improve stability, PSRR.
GND	Common ground pin



Block Diagram

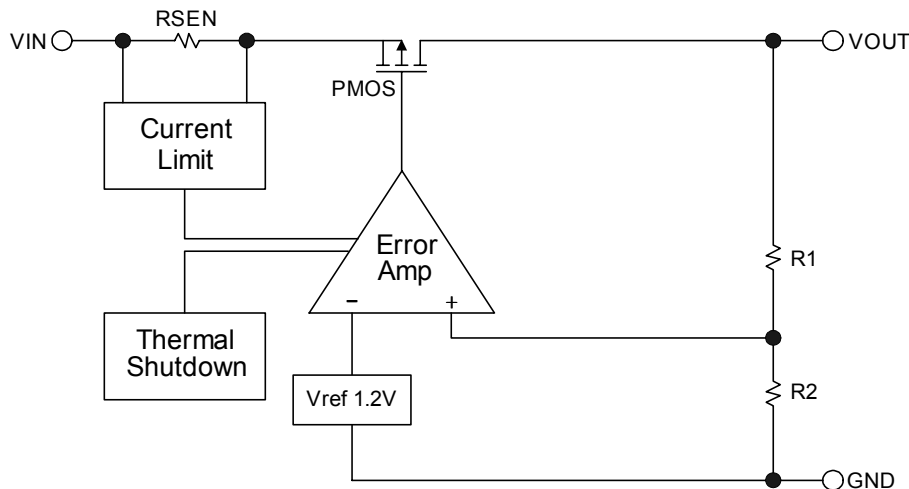

Figure 3. Block Diagram of APE8805

Application Information

The APE8805 series are low dropout linear regulators that could provide 600mA output current at dropout voltage about 600mV. Besides, current limit and on chip thermal shutdown features provide protection against any combination of overload or ambient temperature that could exceed junction temperature.

1. Output and Input Capacitor

The APE8805 regulator is designed to be stable with a wide range of output capacitors. The ESR of the output capacitor affects stability. Larger value of the output capacitor decreases the peak deviations and provides to improve transition response for larger current changes. The capacitor types (aluminum, ceramic, and tant- alum) have different characterizations such as temperature and voltage coefficients. All ceramic capacitors are manufactured with a variety of dielectrics, each with different behavior across temperature and applications. Common dielectrics used are X5R, X7R and Y5V. It is recommended to use 1uF to 10uF X5R or X7R dielectric ceramic capacitors with 30mΩ to 50mΩ ESR range between device outputs to ground for transient stability. The APE8805 is designed to be stable with low ESR ceramic capacitors and higher values of capacitors and ESR could improve output stability. So the

ESR of output capacitor is very important because it generates a zero to provide phase lead for loop stability.

There are no requirements for the ESR on the input capacitor, but its voltage and temperature coefficient have to be considered for device application environment.

2. Protection Features

In order to prevent overloading or thermal condition from damaging device, APE8805 regulator has internal thermal and current limiting functions designed to protect the device. It will rapidly shut off PMOS pass element during overloading or over temperature condition.

3. Thermal Consideration

The power handling capability of the device will be limited by maximum operation junction temperature (125°C). The power dissipated by the device will be estimated by $PD = I_{OUT} \times (V_{IN} - V_{OUT})$. The power dissipation should be lower than the maximum power dissipation listed in "Absolute Maximum Ratings" section.



Typical Performance Curves

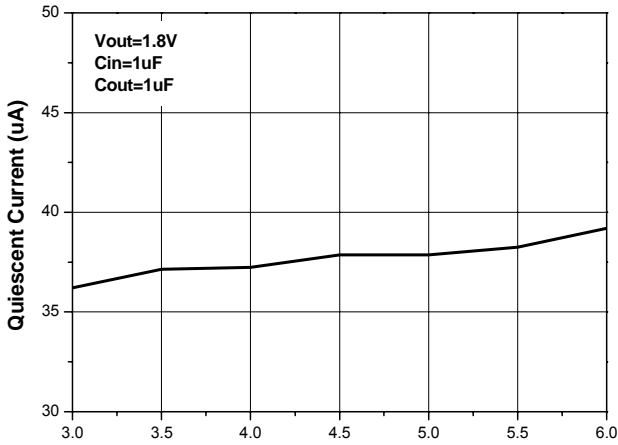

Figure 4. Quiescent Current vs. Input Voltage

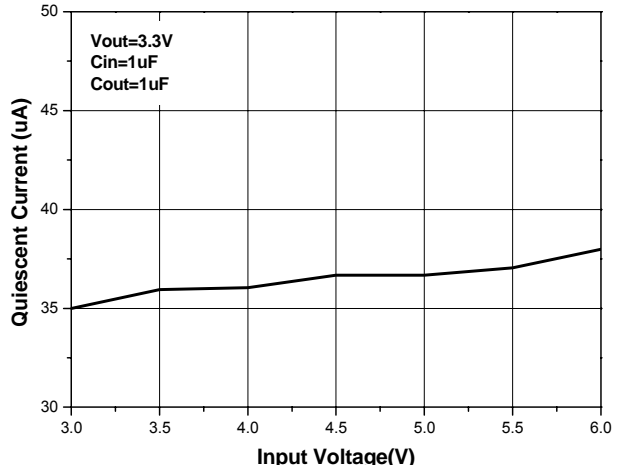

Figure 5. Quiescent Current vs. Input Voltage

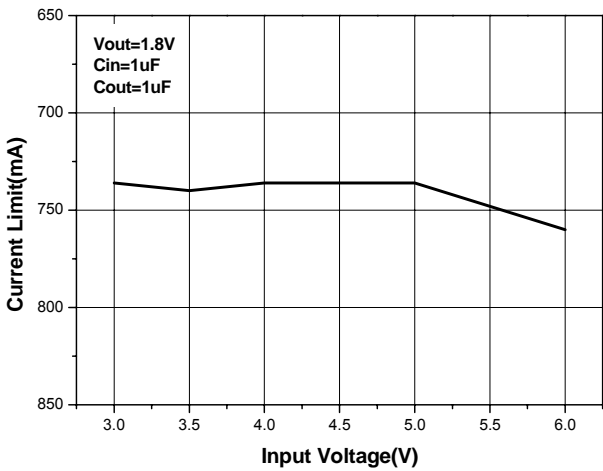

Figure 6. Current limit vs. Input Voltage

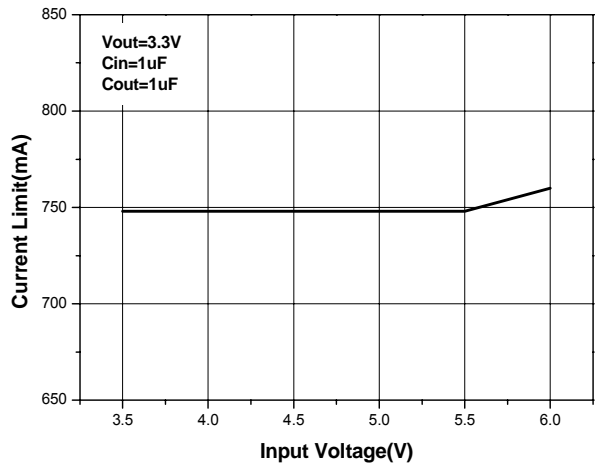

Figure 7. Current Limit vs. Input Voltage

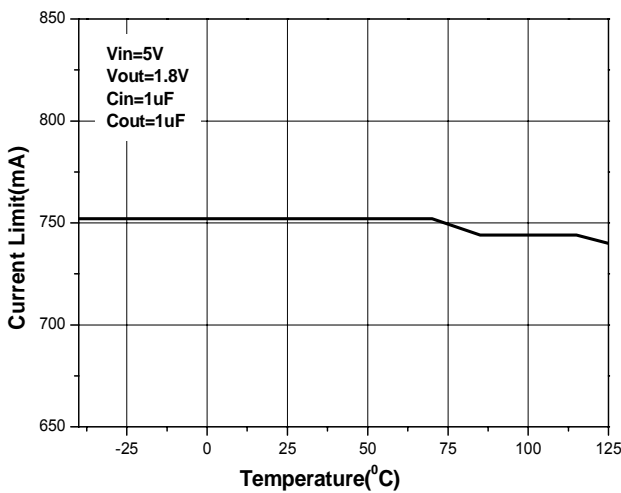

Figure 8. Current limit vs. Temperature

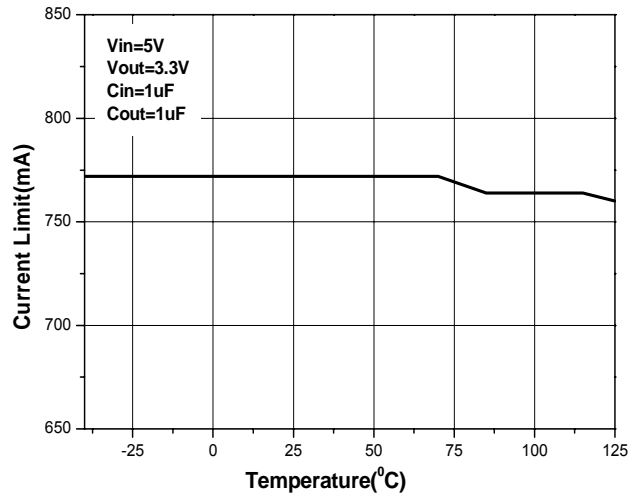

Figure 9. Current limit vs. Temperature



Typical Performance Curves (Continued)

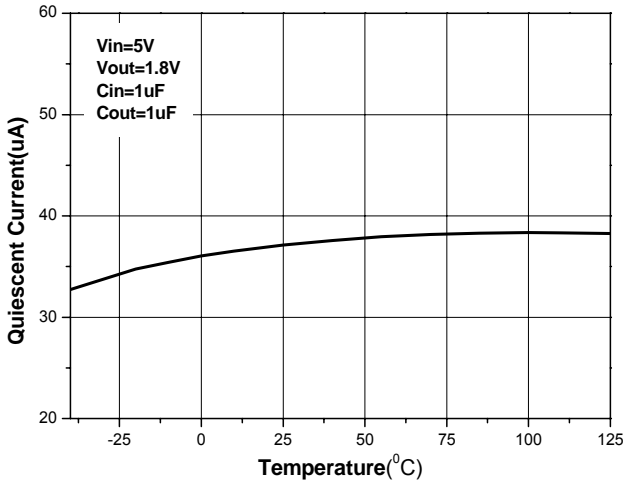

Figure 10. Quiescent Current vs. Temperature

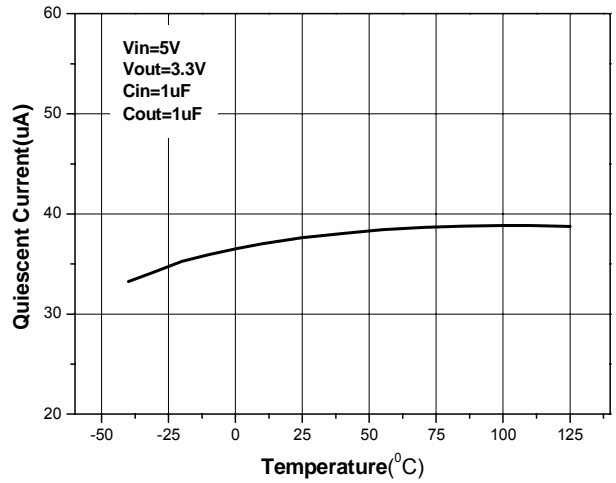

Figure 11. Quiescent Current vs. Temperature

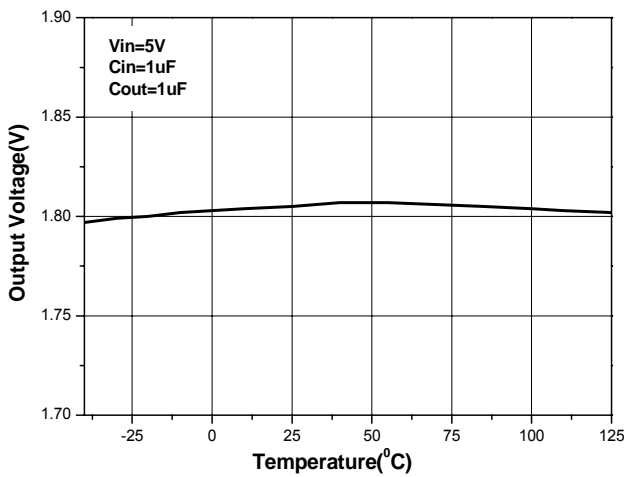

Figure 12. Temperature Stability

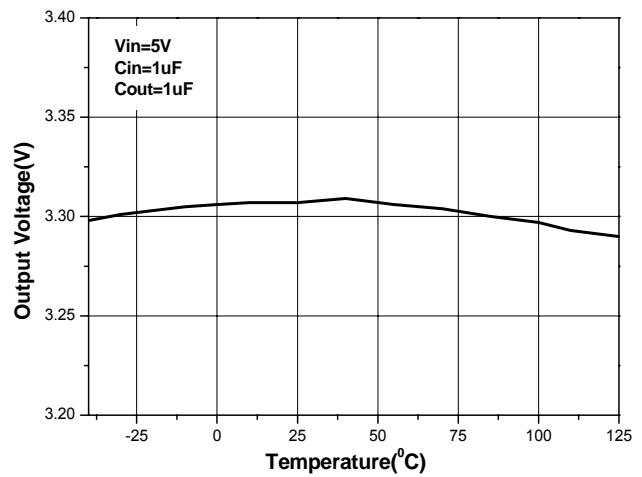

Figure 13. Temperature Stability

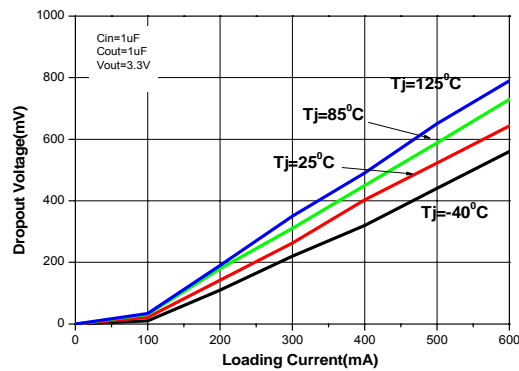

Figure 14. Dropout Voltage vs. Loading Current



Typical Performance Curves (Continued)

$V_{IN}=4V$ $I_{OUT}=1mA$ to $150mA$
 $V_{OUT}=3.3V$ $C_{IN}=1\mu F$ $C_{OUT}=1\mu F$

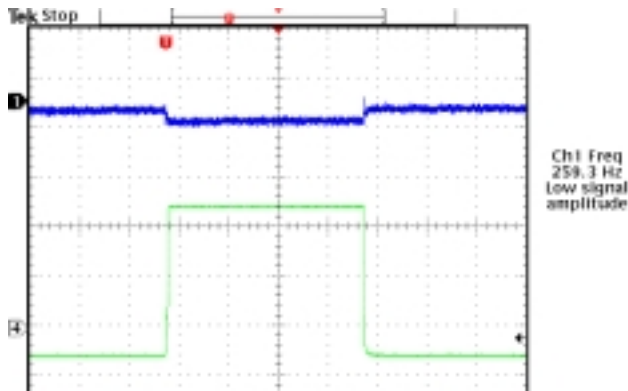

Figure 15. Load Transition Response

$V_{IN}=4V$ $I_{OUT}=1mA$ to $150mA$
 $V_{OUT}=3.3V$ $C_{IN}=1\mu F$ $C_{OUT}=4.7\mu F$

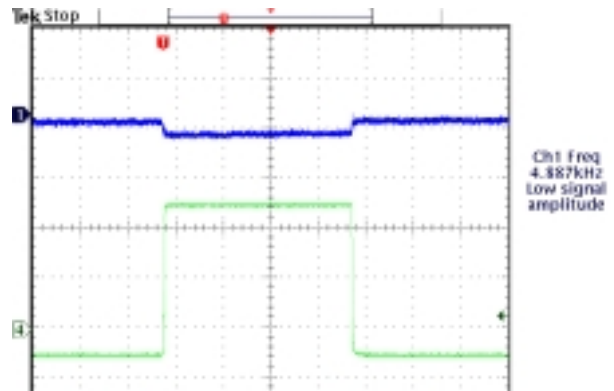

Figure 16. Load Transition Response

$V_{IN}=3V$ to $4V$ $I_{OUT}=10mA$ $V_{OUT}=1.8V$ $C_{IN}=1\mu F$ $C_{OUT}=1\mu F$

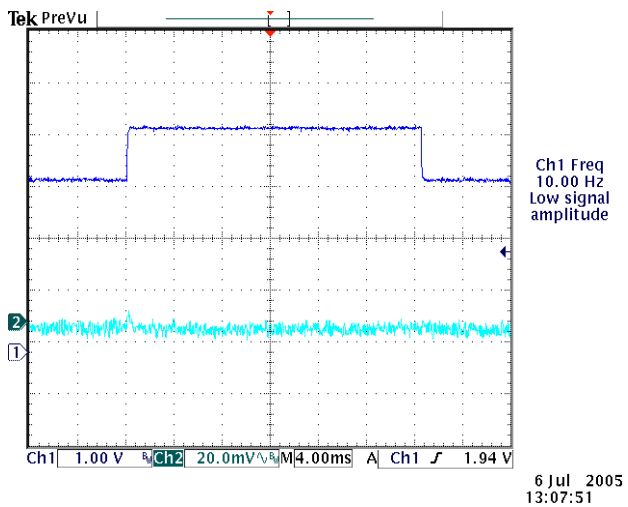

Figure 17. Line Transition Response

$V_{IN}=3V$ to $4V$ $I_{OUT}=10mA$ $V_{OUT}=1.8V$ $C_{IN}=1\mu F$ $C_{OUT}=4.7\mu F$

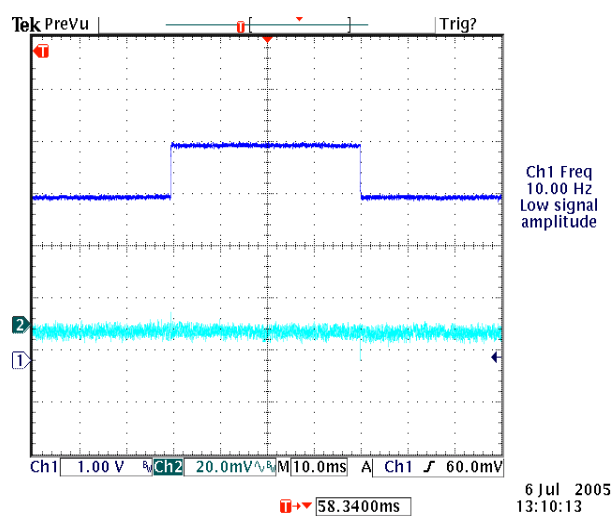
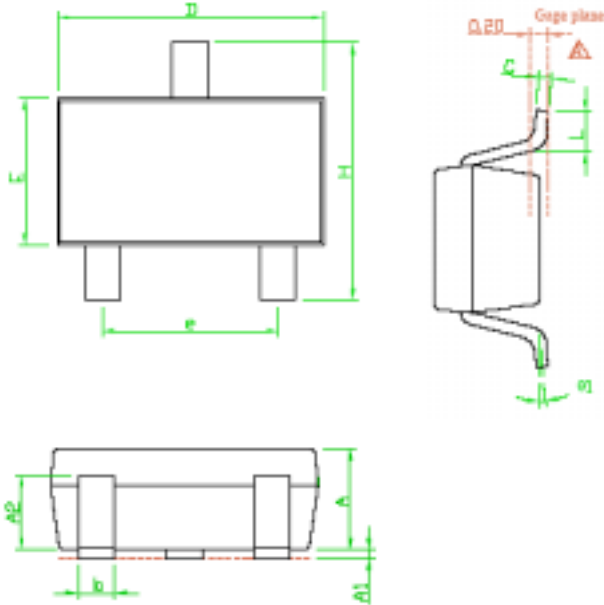

Figure 18. Line Transition Response



Outline Information

SOT-23 Package (Unit: mm)



SYMBOLS UNIT	DIMENSION IN MILLIMETER		
	MIN	NOM	MAX
A	1.00	1.10	1.30
A1	0.00	---	0.10
A2	0.70	0.80	0.90
b	0.35	0.40	0.50
C	0.10	0.15	0.25
D	2.70	2.90	3.10
E	1.40	1.60	1.80
e	---	1.90(TYP)	---
H	2.60	2.80	3.00
L	0.37	---	---
θ1	1°	5°	9°

- Note 1 : Package Body Sizes Exclude Mold Flash Protrusions or Gate Burrs.
- Note 2 : Tolerance ± 0.1000 mm(4mil) Unless Otherwise Specified.
- Note 3 : Coplanarity : 0.1000 mm
- Note 4 : Dimension L Is Measured in Gage plane.

SOT-89 Package (Unit: mm)

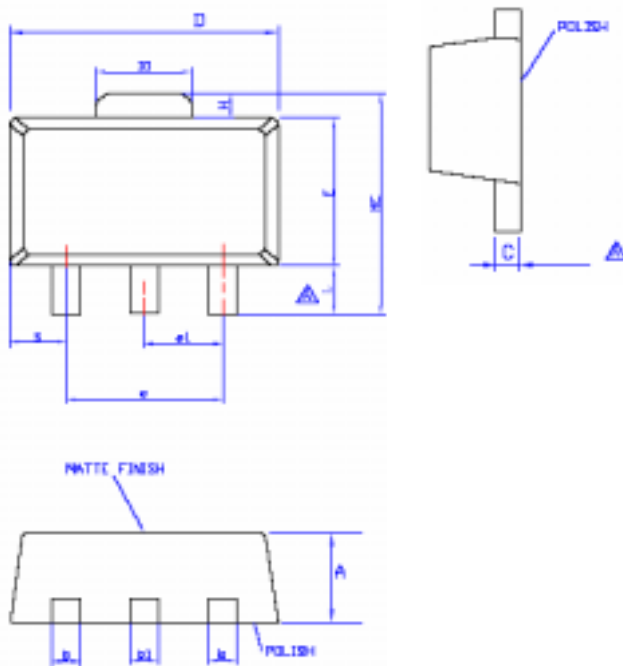

SYMBOLS UNIT	DIMENSION IN MILLIMETER		
	MIN	NOM	MAX
A	1.40	1.50	1.60
L	0.89	1.04	1.20
b	0.36	0.42	0.48
b1	0.41	0.47	0.53
C	0.38	0.40	0.43
D	4.40	4.50	4.60
D1	1.40	1.60	1.75
HE	---	---	4.25
E	2.40	2.50	2.60
e	2.90	3.00	3.10
H	0.35	0.40	0.45
S	0.65	0.75	0.85
e1	1.40	1.50	1.60



SOT-223 Package (Unit: mm)

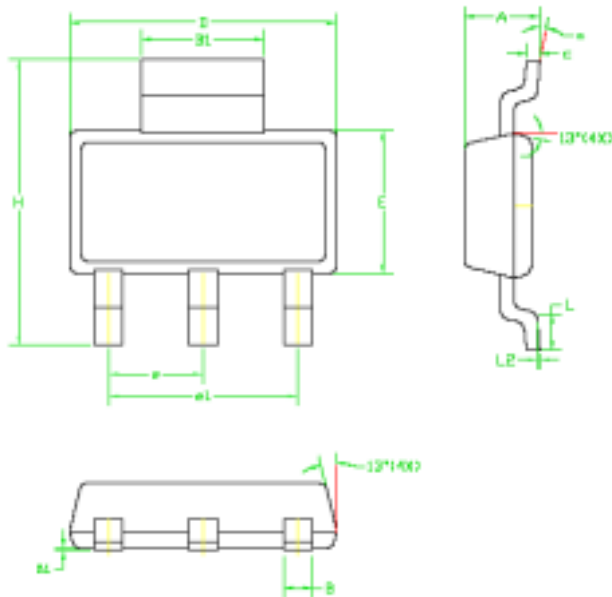

SYMBOLS UNIT	DIMENSION IN MILLIMETER		
	MIN	NOM	MAX
A	1.55		1.80
A1	0.02		0.12
B	0.60		0.80
B1	2.90		3.10
c	0.24		0.32
D	6.30		6.70
E	3.30		3.70
e	2.30 BSC		
e1	4.60 BSC		
H	6.70		7.30
L	0.90 MIN		
L2	0.06 BSC		
α	0°		10°

Life Support Policy

APEC's products are not authorized for use as critical components in life support devices or other medical systems.