

White High-Intensity LED Lamp (3 mm, 40° Viewing Angle)

OVLAW4CB7

- High luminous intensity
- Through-hole type
- Clear lens
- High efficiency

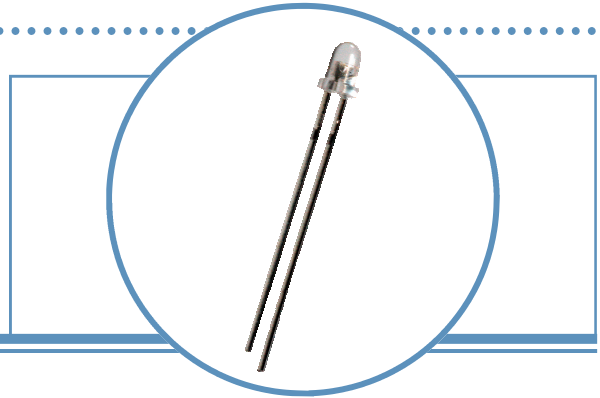

The **OVLAW4CB7** is a round 3mm white high-intensity through-hole lamp with a 40° viewing angle. It is designed for wide-angle uniform light output.

Applications

- Indicators for medical, industrial, consumer and office equipment
- Indicators for white goods and home appliances
- Interior and exterior architectural and accent lighting
- Signs and digital information displays, video screen non-color and RGB presentation
- Automotive backlighting and indicators

Part Number	Material	Emitted Color	Intensity Typ. mcd	Lens Color
OVLAW4CB7	InGaN	White	6200	Clear

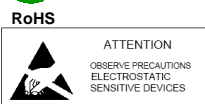
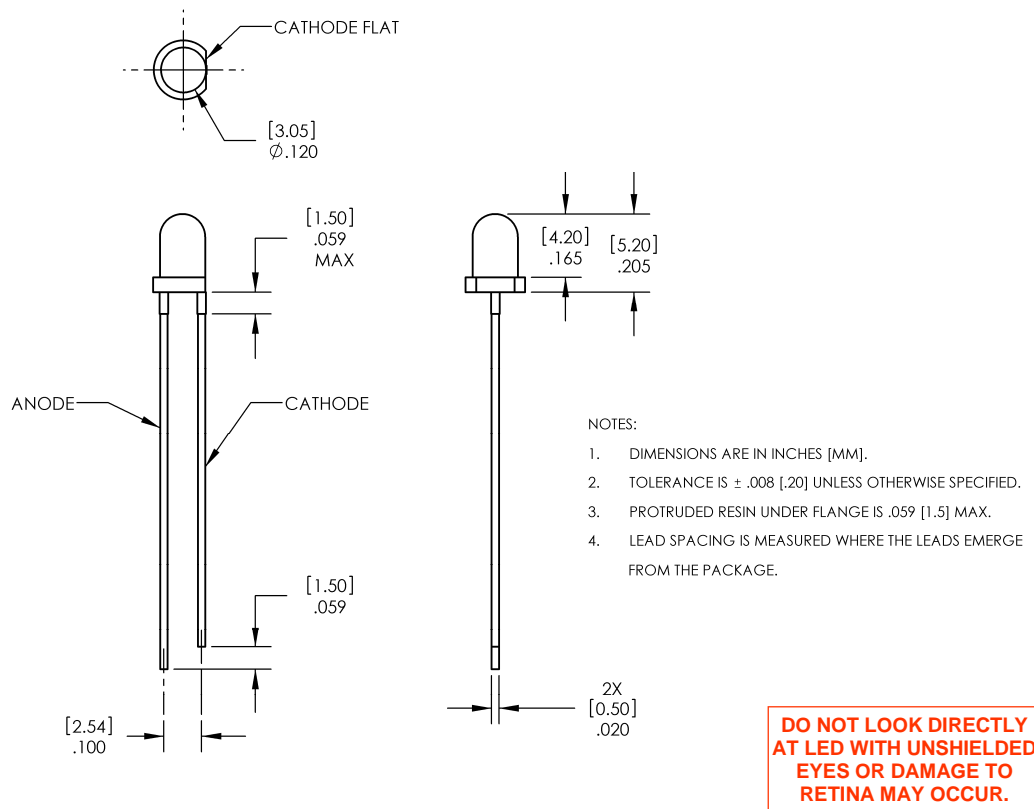

DO NOT LOOK DIRECTLY AT LED WITH UNSHIELDED EYES OR DAMAGE TO RETINA MAY OCCUR.

OPTEK reserves the right to make changes at any time in order to improve design and to supply the best product possible.

White High-Intensity LED Lamp

OVLAW4CB7



Absolute Maximum Ratings (T_A = 25° C unless otherwise noted)

Storage Temperature Range	-40 ~ +100° C
Operating Temperature Range	-40 ~ +100° C
Reverse Voltage	5 V
Power Dissipation	100 mW
Average Forward Current	25 mA
Peak Forward Current (Duty Ratio = 1/10, Pulse Width = 0.1 ms)	100 mA
Current Linearity vs Ambient Temperature	-0.29 mA/° C
LED Junction Temperature	125° C
Electrostatic Discharge Classification (JEDEC-JESD22-A114F)	Class 1C
Lead Soldering Temperature (5 seconds maximum)	260° C

Electrical and Optical Characteristics (T_A = 25° C unless otherwise noted)

SYMBOL	PARAMETER	MIN	TYP	MAX	UNITS	CONDITIONS
I _V	Luminous Intensity	4,360	6,200	----	mcd	I _F = 20 mA
2θ _½	50% Power Angle	----	40	----	deg	I _F = 20 mA
V _F	Forward Voltage	----	3.2	4.0	V	I _F = 20 mA
I _R	Reverse Current	----	----	10	μA	V _R = 5 V
x	Chromaticity Coordinates	----	0.31	----	----	I _F = 20 mA
y		----	0.32	----	----	I _F = 20 mA

Standard Bins

LEDs are sorted to the Luminous Intensity (I_V) Forward Voltage (V_F) and CCT bins listed below. Each bag consists of a single I_V bin, a single V_F bin and a single CCT bin. Orders are filled utilizing all of the I_V, V_F and CCT bins listed in the following tables. Optek will not accept orders for single I_V, V_F or CCT bins.

I _V	Luminous Intensity	
	Bin	Min (mcd) Max (mcd)
0W	4,360	6,105
0X	6,105	8,550
0Y	8,550	11,970

V _F	Forward Voltage	
	Bin	Min Max
A	2.6	2.8
B	2.8	3.0
C	3.0	3.2
D	3.2	3.4
E	3.4	3.6
F	3.6	3.8
G	3.8	4.0

OPTEK reserves the right to make changes at any time in order to improve design and to supply the best product possible.

White High-Intensity LED Lamp

OVLAW4CB7



Standard Bins

LEDs are sorted to the Luminous Intensity (I_V) Forward Voltage (V_F) and CCT bins listed below. Each bag consists of a single I_V bin, a single V_F bin and a single CCT bin. Orders are filled utilizing all of the I_V , V_F and CCT bins listed in the following tables. Optek will not accept orders for single I_V , V_F or CCT bins.

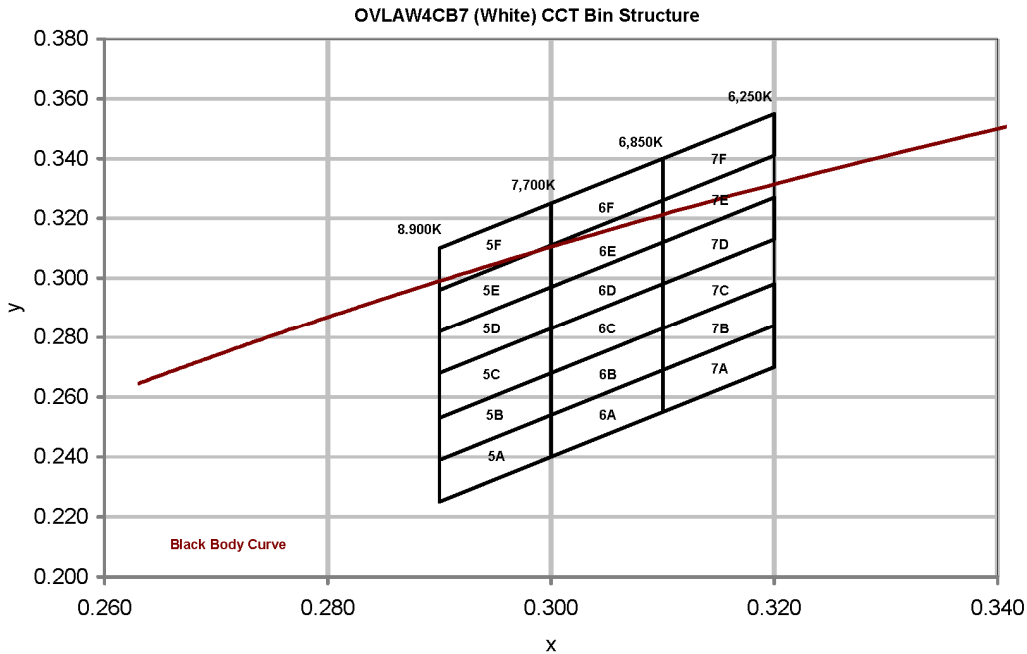

Chromaticity Coordinates (x, y)

Rank	5A				5B				5C				
Cx	Bin 9	0.300	0.290	0.290	0.300	0.300	0.290	0.290	0.300	0.300	0.290	0.290	0.300
Cy		0.254	0.239	0.225	0.240	0.268	0.253	0.239	0.254	0.283	0.268	0.253	0.268
Rank	5D				5E				5F				
Cx	Bin 10	0.300	0.290	0.290	0.300	0.300	0.290	0.290	0.300	0.300	0.290	0.290	0.300
Cy		0.297	0.282	0.268	0.283	0.311	0.296	0.282	0.297	0.325	0.310	0.296	0.311
Rank	6A				6B				6C				
Cx	Bin 11	0.310	0.300	0.300	0.310	0.310	0.300	0.300	0.310	0.310	0.300	0.300	0.310
Cy		0.269	0.254	0.240	0.255	0.283	0.268	0.254	0.269	0.298	0.283	0.268	0.283
Rank	6D				6E				6F				
Cx	Bin 12	0.310	0.300	0.300	0.310	0.310	0.300	0.300	0.310	0.310	0.300	0.300	0.310
Cy		0.312	0.297	0.283	0.298	0.326	0.311	0.297	0.312	0.340	0.325	0.311	0.326
Rank	7A				7B				7C				
Cx	Bin 13	0.310	0.320	0.320	0.310	0.310	0.320	0.320	0.310	0.310	0.320	0.320	0.310
Cy		0.269	0.284	0.270	0.255	0.283	0.298	0.284	0.269	0.298	0.313	0.298	0.283
Rank	7D				7E				7F				
Cx	Bin 14	0.310	0.320	0.320	0.310	0.310	0.320	0.320	0.310	0.310	0.320	0.320	0.310
Cy		0.312	0.327	0.313	0.298	0.326	0.341	0.327	0.312	0.340	0.355	0.341	0.326

OPTeK reserves the right to make changes at any time in order to improve design and to supply the best product possible.

Typical Electro-Optical Characteristics Curves

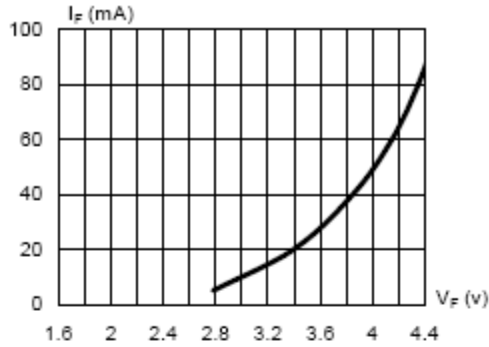

Fig.1 Forward Current vs. Forward Voltage

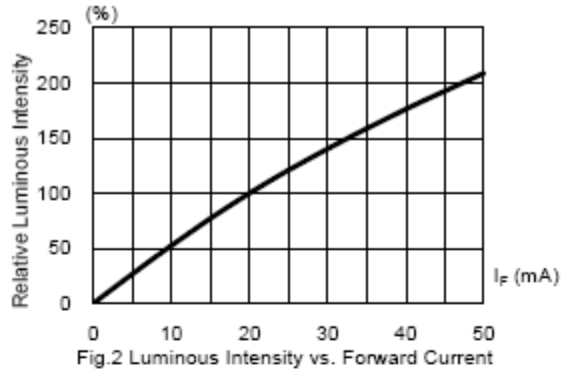

Fig.2 Luminous Intensity vs. Forward Current

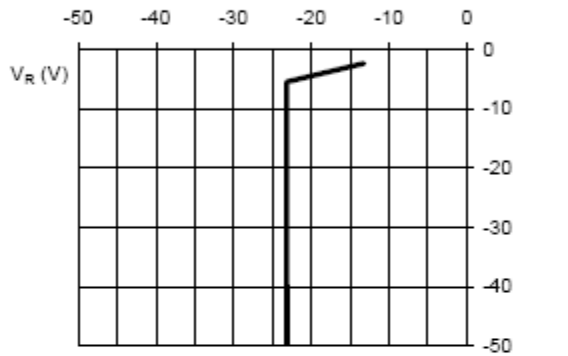

Fig.3 Reverse Current vs. Reverse Voltage

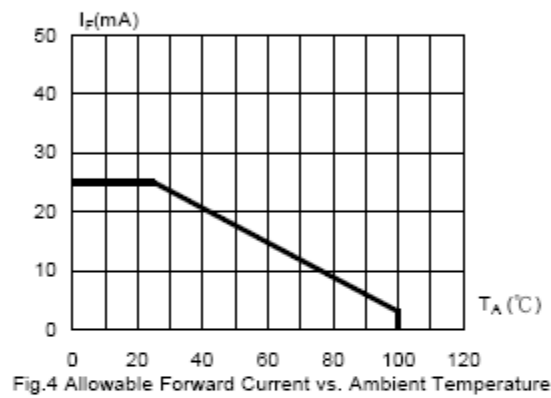

Fig.4 Allowable Forward Current vs. Ambient Temperature

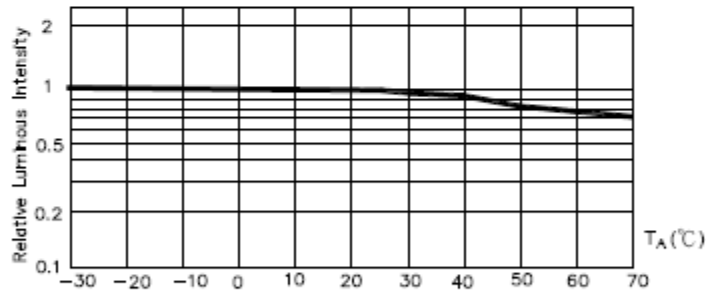

Fig.5 Luminous Intensity at $I_F=20mA$ vs. Ambient Temperature

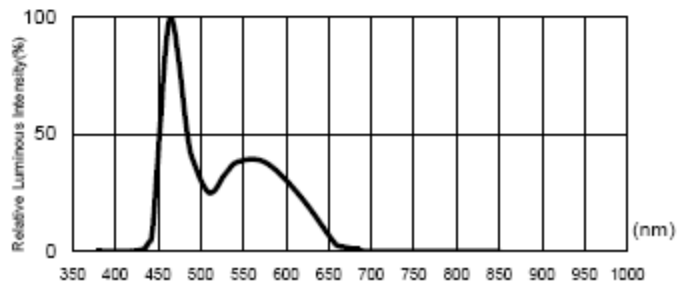
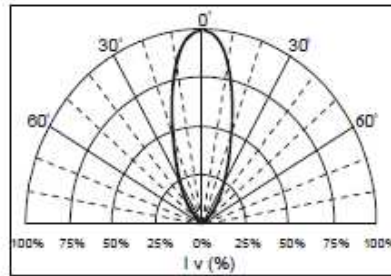

Fig.6. Relative Luminous Intensity vs. Wavelength

Note: The data shown above are typical curves. Every LED component may have some variations.

OPTEK reserves the right to make changes at any time in order to improve design and to supply the best product possible.

Beam Pattern



Soldering:

Soldering heat may damage the LED. Careful attention should be paid during the soldering process and PCB assembly. In order to eliminate the stress of heat shock, please solder the LEDs no closer than 3mm from the base of the epoxy bulb.

Recommended Soldering Conditions:

	Wave Soldering	Manual Solder Dipping	Hand Soldering by Iron
Pre-heat Temperature	105°C Max		
Pre-heat Time	30 seconds Max		
Peak Temperature	250°C Max	260°C Max	350°C Max
Dwell Time	3 seconds Max	5 seconds Max	3 seconds Max

Packaging: 500 pcs per bulk bag

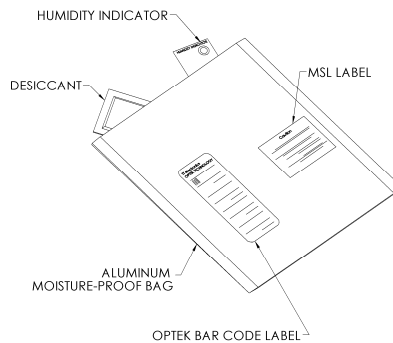

OPTEK reserves the right to make changes at any time in order to improve design and to supply the best product possible.

Reliability Test

LED lamps are checked by reliability tests based on MIL standards.

1. Test Conditions, Acceptable Criteria & Results:

Classification	Test Item	Standard Test Method	Test Conditions	Duration	Unit	Acc / Rej Criteria	Result
Life Test	Operation Life Test (OLT)	MIL-STD-750D Method 1026.3	$T_A=25^{\circ}\text{C}$, $I_F=30\text{mA}$ *	1000 Hrs	100	0 / 1	Pass
Environment Test	High Temperature Storage (HTS)	MIL-STD-750D Method 1032.1	$T_A=100^{\circ}\text{C}$	1000 Hrs	100	0 / 1	Pass
	Low Temperature Storage (LTS)	MIL-STD-750D Method 1032.1	$T_A=-40^{\circ}\text{C}$	1000 Hrs	100	0 / 1	Pass
	Temp. & Humidity with Bias (THB)	MIL-STD-750D Method 103B	$T_A=85^{\circ}\text{C}$, Rh=85% $I_F=20\text{mA}$ **	500 Hrs	100	0 / 1	Pass
	Thermal Shock Test (TST)	MIL-STD-750D Method 1056.1	$0^{\circ}\text{C} \sim 100^{\circ}\text{C}$ 2min 2min	100 cycles	100	0 / 1	Pass
	Temperature Cycling Test (TCT)	MIL-STD-750D Method 1051.5	$-40^{\circ}\text{C} \sim 25^{\circ}\text{C} \sim 100^{\circ}\text{C} \sim 25^{\circ}\text{C}$ 30min 5min 30min 5min	100 cycles	100	0 / 1	Pass
Mechanical Test	Solderability	MIL-STD-750D Method 2026.4	$235\pm 5^{\circ}\text{C}$, 5 sec	1 time	20	0 / 1	Pass
	Resistance to Soldering Heat	MIL-STD-750D Method 2031.1	$260\pm 5^{\circ}\text{C}$, 5 sec	1 time	20	0 / 1	Pass
	Lead Integrity	MIL-STD-750D Method 2036.3	Load 2.5N (0.25kgf) $0^{\circ} \sim 90^{\circ} \sim 0^{\circ}$, bend	3 times	20	0 / 1	Pass

Remark : (*) $I_F=30\text{mA}$ for AlInGaP chip ; $I_F=20\text{mA}$ for InGaN chip

(**) $I_F=20\text{mA}$ for AlInGaP chip ; $I_F=10\text{mA}$ for InGaN chip

2. Failure Criteria ($T_A=25^{\circ}\text{C}$):

Test Item	Symbol	Test Conditions	Criteria for Judgment	
			Min.	Max.
Luminous Intensity	I_V	$I_F=20\text{mA}$	LSL $\times 0.7$ **	
Forward Voltage	V_F	$I_F=20\text{mA}$		USL $\times 1.1$ *

(*) USL : Upper Standard Level , (**) LSL : Lower Standard Level

OPTEK reserves the right to make changes at any time in order to improve design and to supply the best product possible.

Mouser Electronics

Authorized Distributor

Click to View Pricing, Inventory, Delivery & Lifecycle Information:

[Optek:](#)

[OVLAW4CB7](#)