



Part No: GA0451

Date: 9/28/2006

Unit: mm

Description: speaker

Page No: 1 of 2



**Specifications**

Nominal Size	45 mm (1.75 in)	(See attached drawing)
Impedance	8 Ohm $\pm$ 15%	at 800 Hz 1 V
Resonant frequency	500 Hz $\pm$ 100 Hz	at 1 V
Sound pressure level	80 dB/w $\pm$ 3 dB	0.2 w 50 cm ave. at 0.8K, 1.0K, 1.3K, 1.6K Hz
Response	Fo Hz ~9 KHz max 10 dB	
Input power	Nominal 0.2 W	Handling capacity 0.5 W
Operation	must be normal at program source 0.2 W	
Buzz, rattle, etc.	must be normal at sine wave 1.26 V	
Magnet	Size: 13 x 10 mm	
Load test	White noise 0.2 W	for 5 hours
Heat test	70 $\pm$ 2° C	20-50% R.H. 5 hours
Humidity test	40 $\pm$ 2° C	90-95% R.H. 5 hours

**Frequency Response Curve**

Potentiometer range	50 dB
Rectifier	RMS
Lower limit frequency	20 Hz
Wr. speed	100 mm/sec

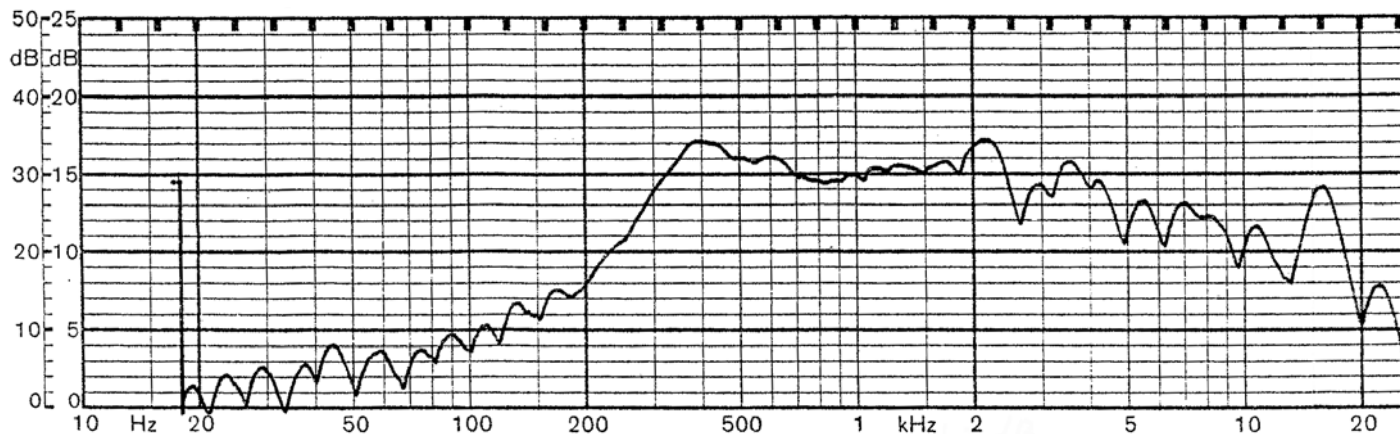

Zero level 50 dB

REV.	DESCRIPTION	DATE
A	NEW DRAWING	9/15/2006

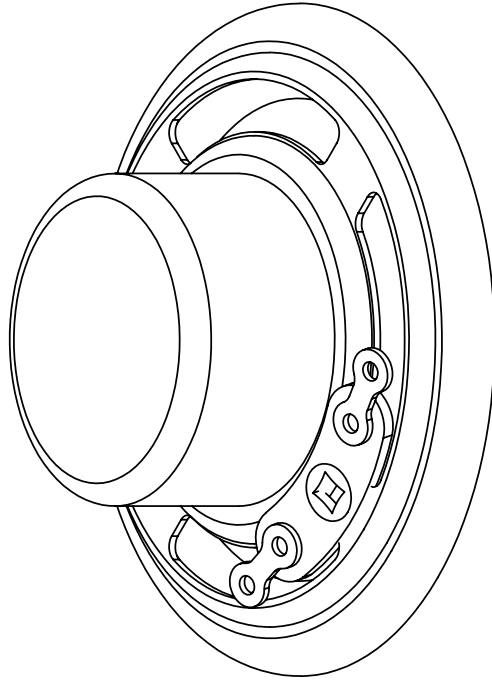
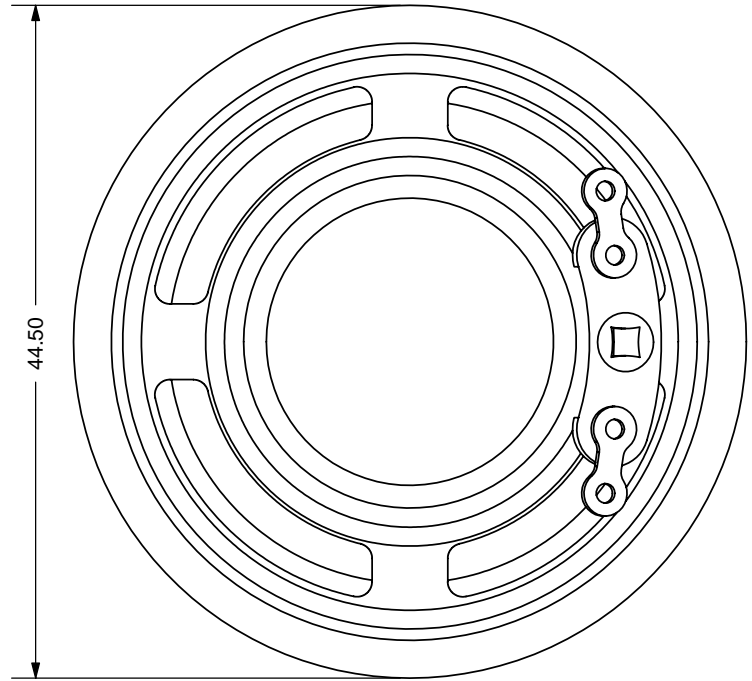
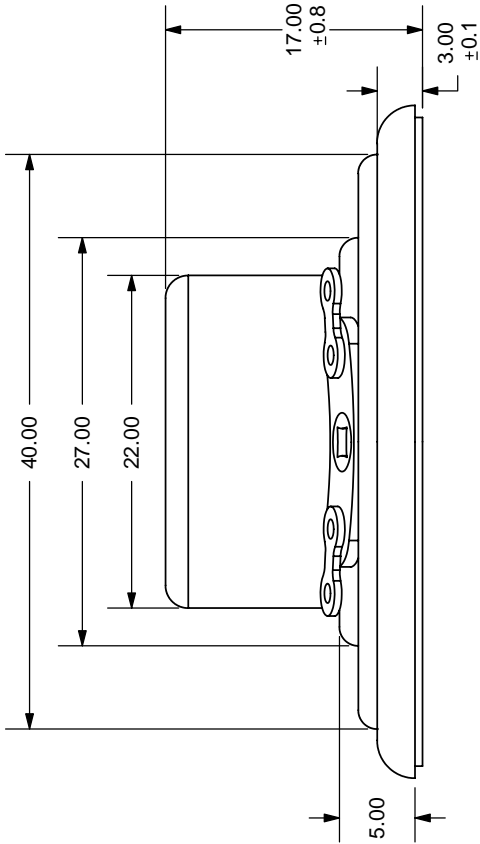

TOLERANCE:  
±0.5mm UNLESS OTHERWISE  
SPECIFIED



**CUI INC**

20050 SW 112th Ave.  
Tualatin, OR 97062  
Phone: 503-643-4899  
800-275-4899  
Fax: 503-372-1266  
Website: www.cui.com

TITLE: Round frame paper cone - alnico magnet	REV: A
PART NO: GA0451	UNITS: MM [INCHES]
DRAWN BY: ZRJ	APPROVED BY:
	SCALE: 2:1