

ASMT-QTBO-0xxxxx

PLCC-4 Surface Mount Tricolor LED



Data Sheet



Lead (Pb) Free
RoHS 6 fully
compliant



Description

This family of SMT LEDs is packaged in the industry standard PLCC-4 package with additional heat sinking capability enabling it to be driven at even higher current. These SMT LEDs have high brightness and reliability performance and are designed to work under a wide range of environmental conditions. This high reliability feature makes them ideally suited to be used under exterior and interior full color signs application conditions.

To facilitate easy pick & place assembly, the LEDs are packed in EIA-compliant tape and reel. Every reel will be shipped in single intensity and color bin; except red color to provide close uniformity.

These LEDs are compatible with reflow soldering process.

This super wide viewing angle at 120° together with the built in reflector pushing up the intensity of the light output makes these LED suitable to be used in the interior electronics signs. The black top surface of the LED provides better contrast enhancement especially in the full color sign application.

Features

- Industry Standard PLCC-4 package (Plastic Leaded Chip Carrier) with additional heat sinking capability
- High reliability LED package with silicone encapsulation
- High brightness using AlInGaP and InGaN dice technologies
- Wide viewing angle at 120°
- Compatible with reflow soldering process
- JEDEC MSL 2a

Applications

- Indoor and outdoor full color display

CAUTION: LEDs are Class 1C ESD sensitive. Please observe appropriate precautions during handling and processing. Please refer to Avago Application Note AN-1142 for additional details.

Package Dimensions

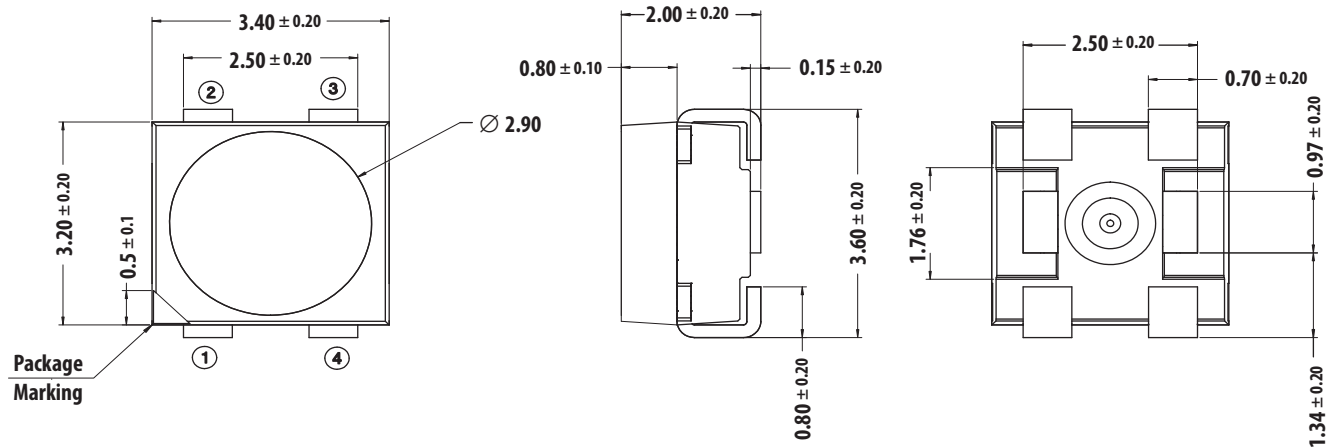

Notes:

1. All Dimensions are in millimeters
2. Tolerance = ± 0.2 mm unless otherwise specified
3. Terminal Finish: Ag plating

Lead Configuration		
1	Cathode	Red
2	Common Anode	
3	Cathode	Blue
4	Cathode	Green

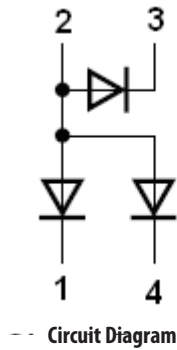

Figure 1. Package drawing.

Table 1. Device Selection Guide

Part Number	Color 1	Color 2	Color 3
ASMT-QTB0-0xxxx	AllInGaP Red	InGaN Green	InGaN Blue

Part Number	Color 1 - Red			Color 2 - Green			Color 3 - Blue		
	Bin ID	Min. Iv @20mA (mcd)	Typ. Iv @20mA (mcd)	Bin ID	Min. Iv @ 20mA (mcd)	Typ. Iv @ 20mA (mcd)	Bin ID	Min. Iv @ 20mA (mcd)	Typ. Iv @ 20mA (mcd)
ASMT-QTB0-0AA02	U1	450	620	V2	900	1200	S2	224	280

Notes:

1. The luminous intensity I_v is measured at the mechanical axis of the LED package. The actual peak of the spatial radiation pattern may not be aligned with this axis.
2. Tolerance = $\pm 12\%$

Part Numbering System

A S M T - Q T B 0 - X₁ X₂ X₃ X₄ X₅

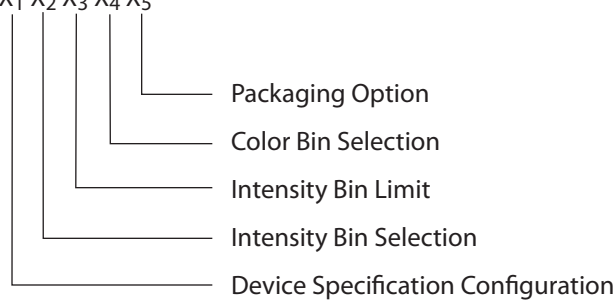

Table 2. Absolute Maximum Ratings (T_A = 25°C)

Parameter	Red	Green & Blue	Unit
DC forward current ^[1]	50	30	mA
Peak forward current ^[2]	100	100	mA
Power dissipation	120	117	mW
Reverse voltage	4V ^[3]		V
Maximum junction temperature T _j max	125		°C
Operating temperature range	- 40 to + 110 ^[4]		°C
Storage temperature range	- 40 to + 110		°C

Notes:

1. Derate linearly as shown in Figure 5a & 5b.
2. Duty Factor = 0.5%, Frequency = 500Hz
3. Driving the LED in reverse bias condition is suitable for short term only
4. Refer to Figure 5a and figure 5b for more information

Table 3. Optical Characteristics (T_A = 25°C)

Color	Dominant Wavelength, λ _d (nm) ^[1]			Peak Wavelength, λ _p (nm)	Viewing Angle 2θ _{1/2} ^[2] (Degrees)	Luminous Efficacy η _v ^[3] (lm/W)	Luminous Efficiency η _e (lm/W)	Total Flux / Luminous Intensity ^[4] Φ _v / I _v (lm/cd)
	Min	Typ.	Max	Typ.	Typ.	Typ.	Typ.	Typ.
Red	618	621	628	629	120	200	43	2.70
Green	525	528	535	521	120	530	50	2.70
Blue	465	470	475	465	120	70	12	2.70

Notes:

1. The dominant wavelength is derived from the CIE Chromaticity Diagram and represents the perceived color of the device.
2. θ_{1/2} is the off axis angle where the luminous intensity is 1/2 the peak intensity
3. Radiant intensity, I_e in watts / steradian, may be calculated from the equation I_e = I_v / η_v, where I_v is the luminous intensity in candelas and η_v is the luminous efficacy in lumens / watt.
4. Φ_v is the total luminous flux output as measured with an integrating sphere at mono pulse condition.

Table 4. Electrical Characteristics ($T_A = 25^\circ\text{C}$)

Color	Forward Voltage, V_F (V) [1]			Reverse Voltage V_R @ 100 μA	Reverse Voltage V_R @ 10 μA	Thermal Resistance $R\theta_{J-P}$ ($^\circ\text{C/W}$)
	Min	Typ.	Max.	Min.	Min.	Typ.
Red	1.80	2.10	2.40	4	-	95
Green	2.80	3.20	3.90	-	4	70
Blue	2.80	3.20	3.90	-	4	60

Note:

1. Tolerance $\pm 0.1\text{V}$

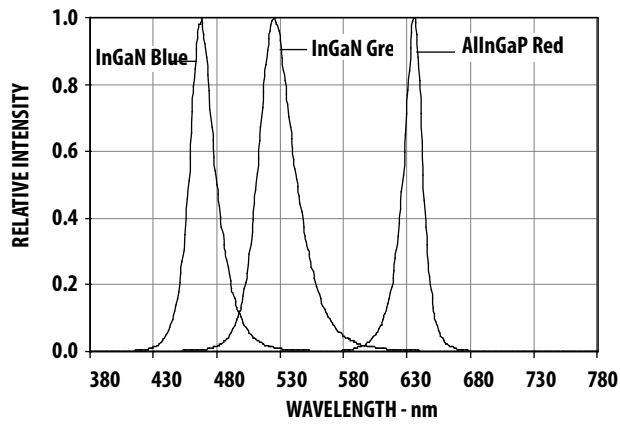

Figure 2. Relative intensity vs. wavelength

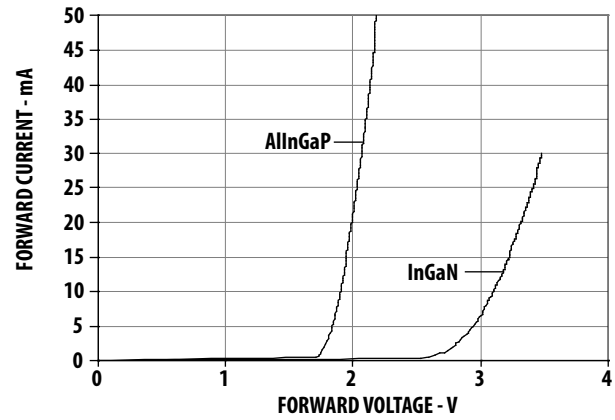

Figure 3. Forward current vs. forward voltage

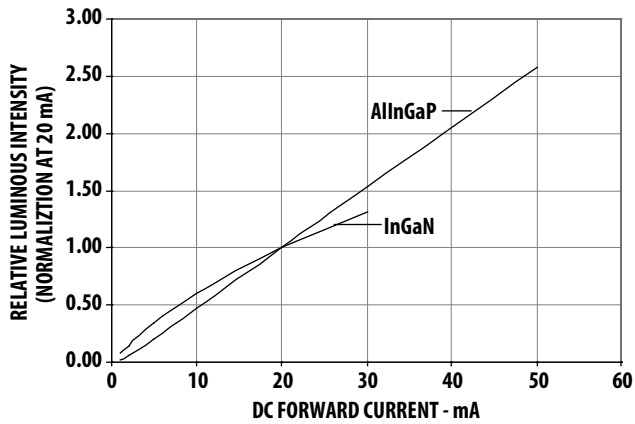

Figure 4. Relative Intensity vs. forward current

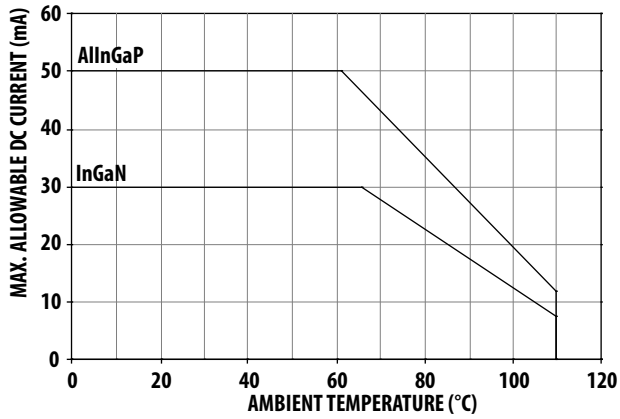

Figure 5a. Maximum forward current vs. ambient temperature. Derated based on $T_{jMAX} = 125^{\circ}C$. (3 chips)

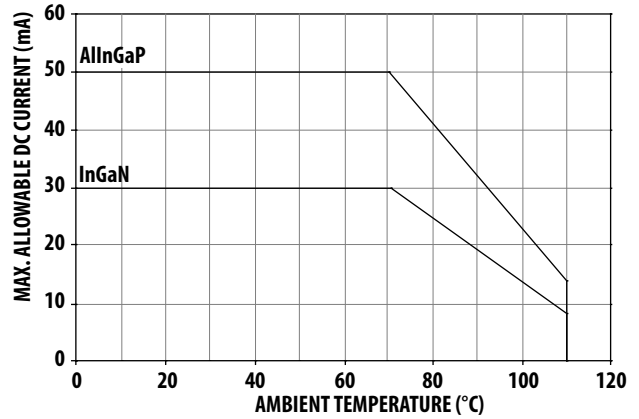

Figure 5b. Maximum forward current vs. ambient temperature. Derated based on $T_{jMAX} = 125^{\circ}C$. (single chip)

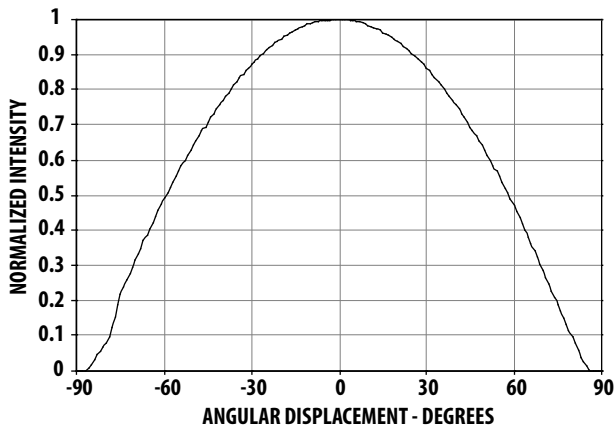

Figure 6. Radiation pattern.

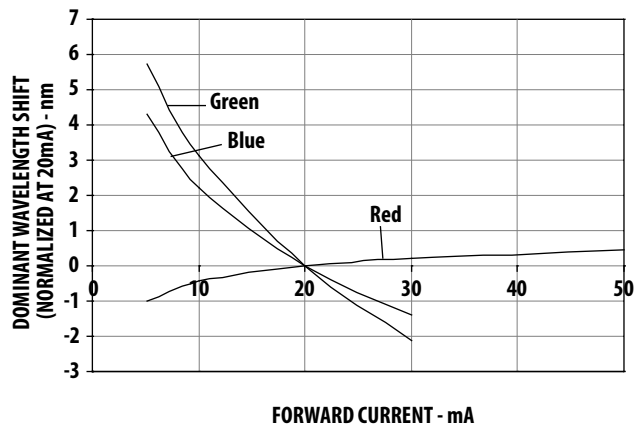

Figure 7. Dominant wavelength shift (normalized at 20mA) vs. forward current

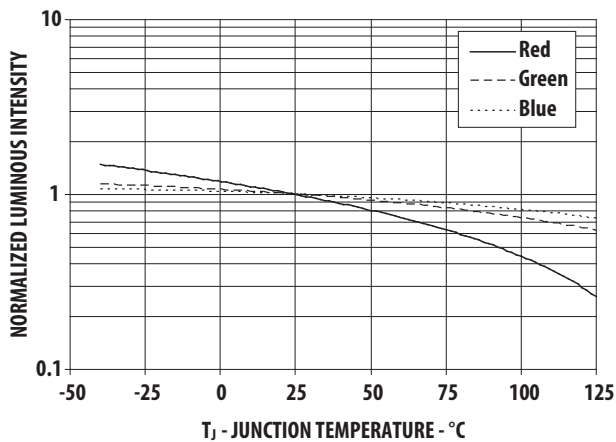

Figure 8. Relative Intensity Shift vs Junction Temperature

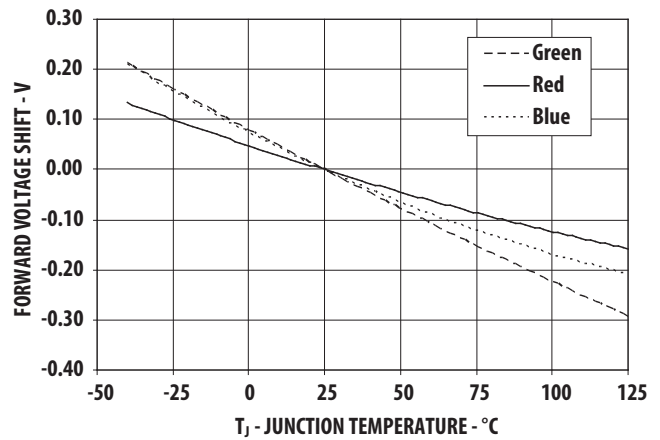

Figure 9. Forward Voltage Shift vs Junction Temperature

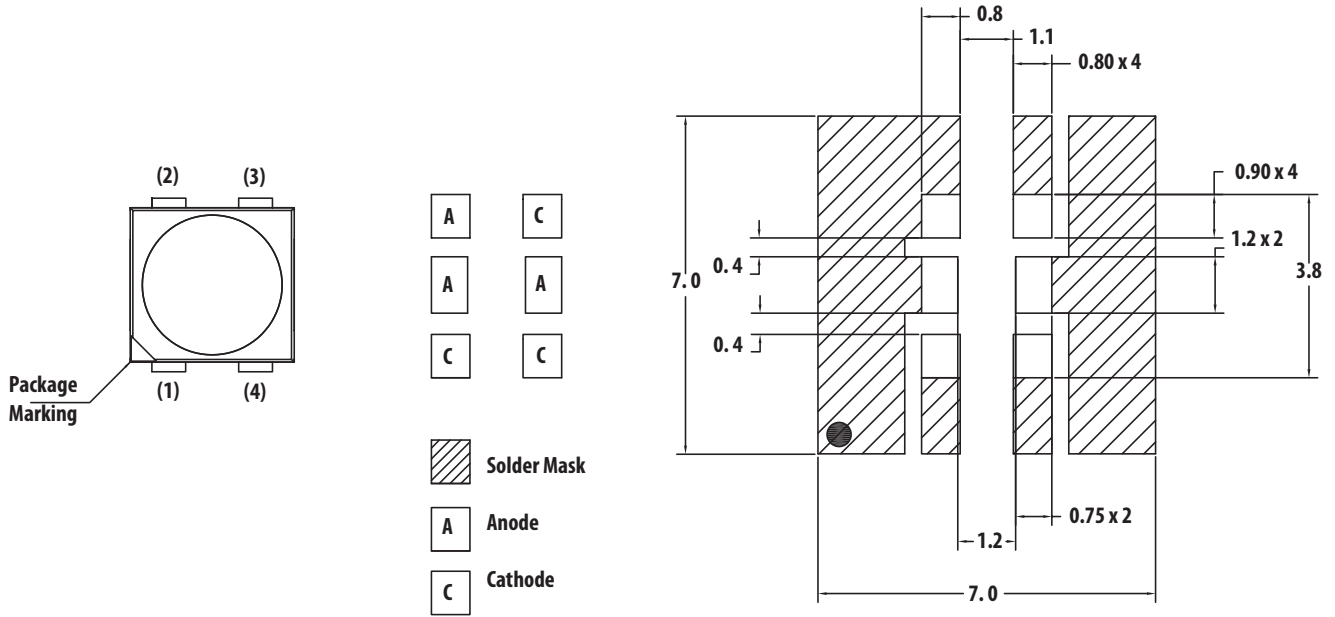

Figure 10. Recommended soldering land pattern.

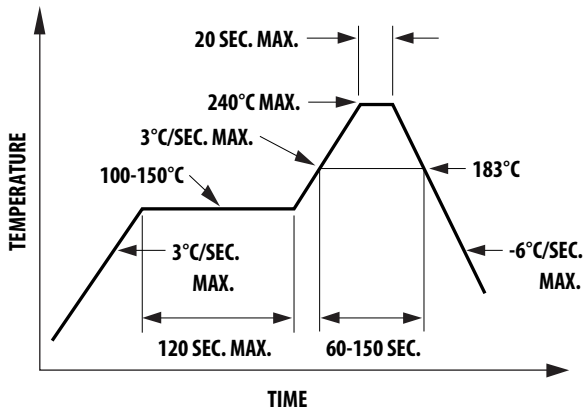

Figure 11. Recommended leaded reflow soldering profile

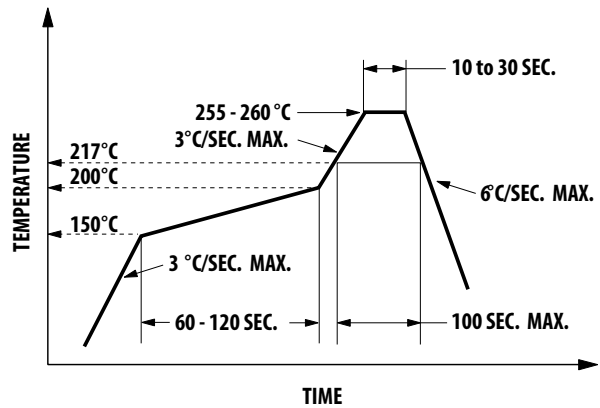

Figure 12. Recommended Pb-free reflow soldering profile.

Note: For detail information on reflow soldering of Avago surface mount LEDs, do refer to Avago Application Note AN 1060 Surface Mounting SMT LED Indicator Components

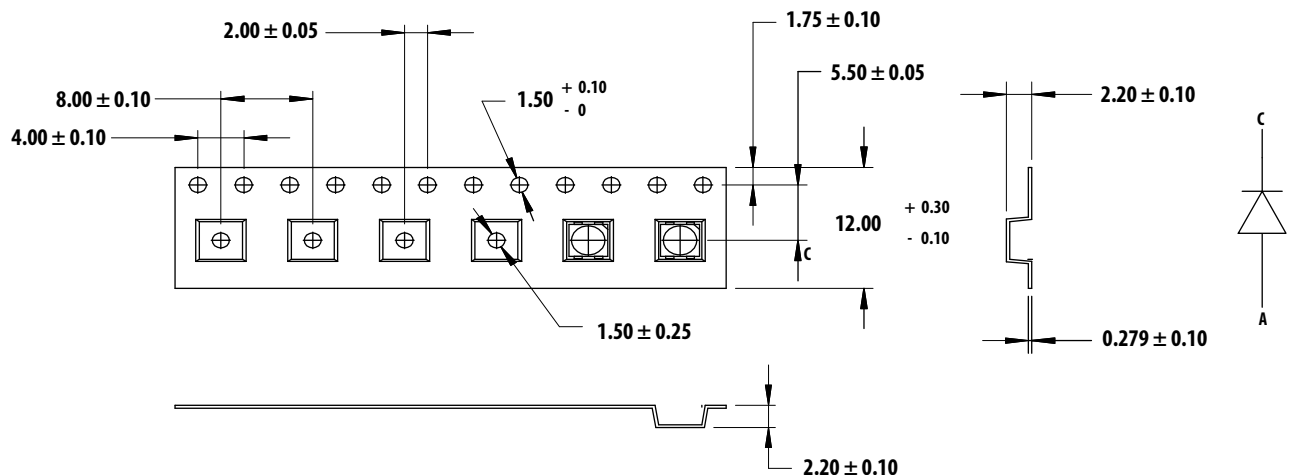

Figure 13. Carrier Tape Dimension

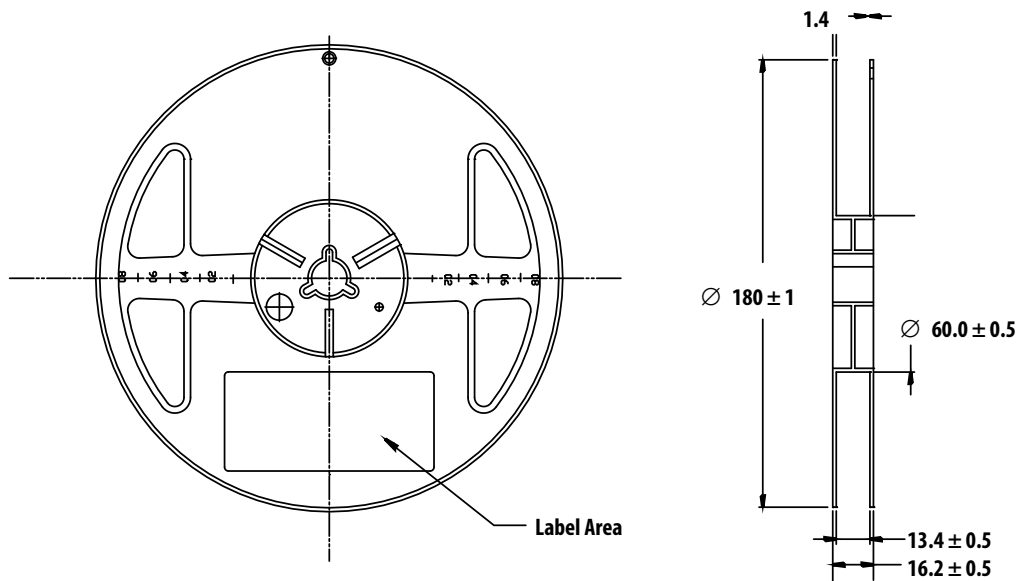

Figure 14. Reel Dimension

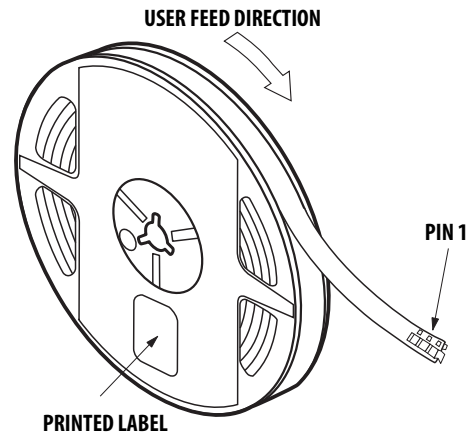

Figure 15. Reeling Orientation

Intensity Bin Select (X_2, X_3)

Individual reel will contain parts from 1 half bin only

X_2	Min Iv Bin (Minimum Intensity Bin)		
	Red	Green	Blue
0	0	0	0
A	U1	V2	S2

X_3	Number of Half bin from X_2		
	Red	Green	Blue
0	0	0	0
A	4	4	4

Note: 0 represents no maximum bin limit

Color Bin Select (X_4)

Individual Reel will contain part from 1 full bin only

X_4	Color Bin Combinations		
	Red	Green	Blue
0	Full distribution	C & D	B & C

Intensity Bin Limits

Bin ID	Min (mcd)	Max (mcd)
S2	224.0	285.0
T1	285.0	355.0
T2	355.0	450.0
U1	450.0	560.0
U2	560.0	715.0
V1	715.0	900.0
V2	900.0	1125.0
W1	1125.0	1400.0
W2	1400.0	1800.0
X1	1800.0	2240.0

Tolerance of each bin limit $\pm 12\%$

Color Bin Limits

Red	Min (nm)	Max (nm)
Full distribution	618.0	628.0

Green	Min (nm)	Max (nm)
C	525.0	530.0
D	530.0	535.0

Blue	Min (nm)	Max (nm)
B	465.0	470.0
C	470.0	475.0

Tolerance of each bin limit is ± 1 nm

Packaging Option (X₅)

Option	Test Current	Package Type	Reel Size
2	20mA	Top mount	7 inch

CIE 1931 - Chromaticity Diagram

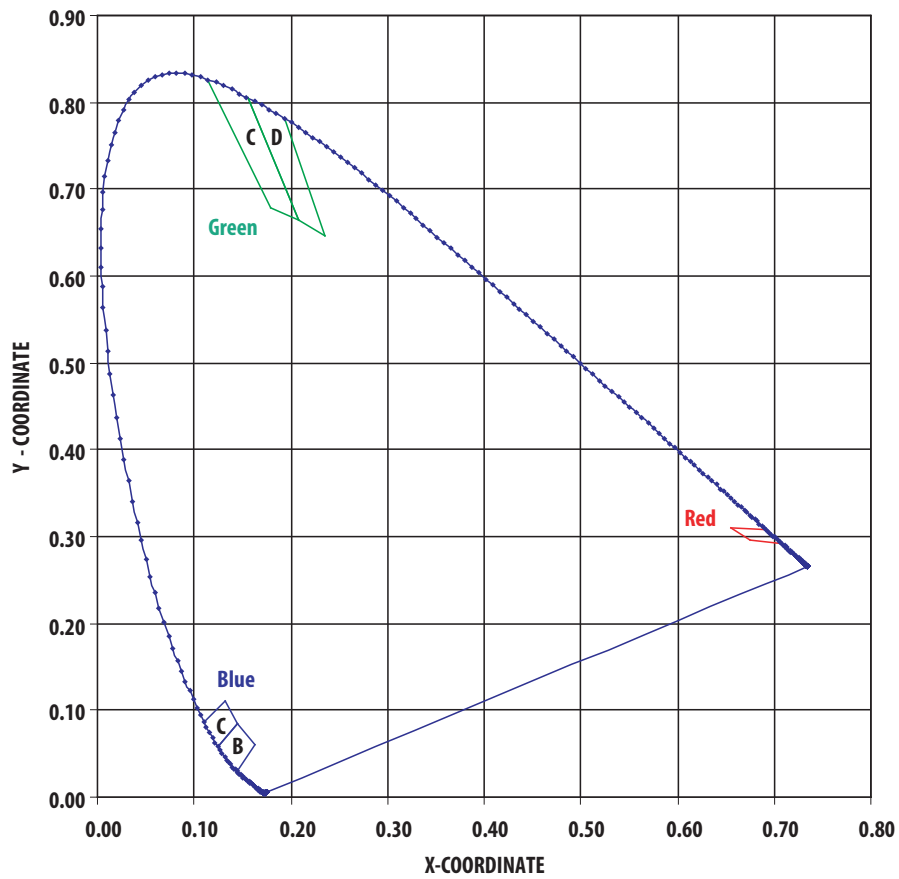

Handling Precaution

The encapsulation material of the product is made of silicone for better reliability of the product. As silicone is a soft material, please do not press on the silicone or poke a sharp object onto the silicone. These might damage the product and cause premature failure. During assembly of handling, the unit should be held on the body only. Please refer to Avago Application Note AN 5288 for detail information.

Moisture Sensitivity

This product is qualified as Moisture Sensitive Level 2a per Jedec J-STD-020. Precautions when handling this moisture sensitive product is important to ensure the reliability of the product. Do refer to Avago Application Note AN5305 Handling of Moisture Sensitive Surface Mount Devices for details.

A. Storage before use

- Unopen moisture barrier bag (MBB) can be stored at <math><40^{\circ}\text{C}</math>/90%RH for 12 months. If the actual shelf life has exceeded 12 months and the HIC indicates that baking is not required, then it is safe to reflow the LEDs per the original MSL rating.
- It is not recommended to open the MBB prior to assembly (e.g. for IQC).

B. Control after opening the MBB

- The humidity indicator card (HIC) shall be read immediately upon opening of MBB.
- The LEDs must be kept at <math><30^{\circ}\text{C}</math> / 60%RH at all time and all high temperature related process including soldering, curing or rework need to be completed within 672 hours.

C. Control for unfinished reel

- For any unused LEDs, they need to be stored in sealed MBB with desiccant or desiccator at <math><5\%</math>RH.

D. Control of assembled boards

- If the PCB soldered with the LEDs is to be subjected to other high temperature processes, the PCB need to be stored in sealed MBB with desiccant or desiccator at <math><5\%</math>RH to ensure no LEDs have exceeded their floor life of 672 hours

E. Baking is required if:

- "10%" or "15%" HIC indicator turns pink
- The LEDs are exposed to condition of $>30^{\circ}\text{C}$ / 60% RH at any time.
- The Led floor life exceeded 672hrs.

Recommended baking condition: $60\pm 5^{\circ}\text{C}$ for 20hrs

For product information and a complete list of distributors, please go to our web site: www.avagotech.com

Avago, Avago Technologies, and the A logo are trademarks of Avago Technologies Limited in the United States and other countries. Data subject to change. Copyright © 2008 Avago Technologies Limited. All rights reserved. AV02-1033EN - March 10, 2008

AVAGO
TECHNOLOGIES