

FEATURES

- **LOW VOLTAGE, LOW CURRENT OPERATION**
- **SMALL PACKAGE OUTLINE:**
1.2 mm x 0.8 mm
- **LOW HEIGHT PROFILE:**
Just 0.50 mm high
- **TWO DIFFERENT DIE TYPES:**
Q1 - Ideal buffer amplifier transistor
Q2 - Ideal oscillator transistor
- **IDEAL FOR 1-2 GHz OSCILLATORS**

DESCRIPTION

NEC's UPA862TD contains one NE851 and one NE685 NPN high frequency silicon bipolar chip. The NE851 is an excellent oscillator chip, featuring low 1/f noise and high immunity to pushing effects. The NE685 is an excellent buffer transistor, featuring low noise and high gain. NEC's new ultra small TD package is ideal for all portable wireless applications where reducing board space is a prime consideration. Each transistor chip is independently mounted and easily configured for oscillator/buffer amplifier and other applications.

OUTLINE DIMENSIONS (Units in mm)

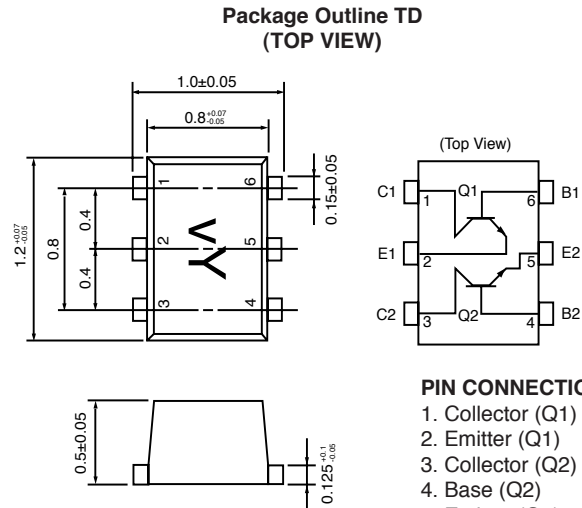

ELECTRICAL CHARACTERISTICS (TA = 25°C)

PART NUMBER PACKAGE OUTLINE				UPA862TD TD		
	SYMBOLS	PARAMETERS AND CONDITIONS	UNITS	MIN	TYP	MAX
Q1	ICBO	Collector Cutoff Current at VCB = 5 V, IE = 0	nA			100
	IEBO	Emitter Cutoff Current at VEB = 1 V, IC = 0	nA			100
	hFE	DC Current Gain ¹ at VCE = 3 V, IC = 10 mA		75	110	150
	fr	Gain Bandwidth at VCE = 3 V, IC = 10 mA, f = 2 GHz	GHz	10	12	
	Cre	Feedback Capacitance ² at VCB = 3 V, IE = 0, f = 1 MHz	pF		0.4	0.7
	IS21EI ²	Insertion Power Gain at VCE = 3 V, IC = 10 mA, f = 2 GHz	dB	7	8.5	
	NF	Noise Figure at VCE = 3 V, IC = 3 mA, f = 2 GHz	dB		1.5	2.5
Q2	ICBO	Collector Cutoff Current at VCB = 10 V, IE = 0	nA			600
	IEBO	Emitter Cutoff Current at VEB = 1 V, IC = 0	nA			600
	hFE	DC Current Gain ¹ at VCE = 3 V, IC = 7 mA		100	120	145
	fr	Gain Bandwidth at VCE = 1 V, IC = 15 mA, f = 2 GHz	GHz	5.0	6.5	
	Cre	Feedback Capacitance ² at VCB = 3 V, IE = 0, f = 1 MHz	pF		0.6	0.8
	IS21EI ²	Insertion Power Gain at VCE = 1 V, IC = 5 mA, f = 2 GHz	dB	3.0	4.0	
	IS21EI ²	Insertion Power Gain at VCE = 1 V, IC = 15 mA, f = 2 GHz	dB	4.5	5.5	
NF	Noise Figure at VCE = 1 V, IC = 10 mA, f = 2 GHz	dB		1.9	2.5	

- Notes: 1. Pulsed measurement, pulse width ≤ 350 μs, duty cycle ≤ 2 %.
2. Collector to base capacitance when measured with capacitance meter (automatic balanced bridge method), with emitter connected to guard pin of capacitances meter.

ABSOLUTE MAXIMUM RATINGS^{1,2} (T_A = 25°C)

SYMBOLS	PARAMETERS	UNITS	RATINGS	
			Q1	Q2
V _{CB0}	Collector to Base Voltage	V	9	9
V _{CEO}	Collector to Emitter Voltage	V	6	5.5
V _{EBO}	Emitter to Base Voltage	V	2	1.5
I _C	Collector Current	mA	30	100
P _T	Total Power Dissipation ¹	mW	180	192
			210 Total	
T _J	Junction Temperature	°C	150	150
T _{STG}	Storage Temperature	°C	-65 to +150	

Note: 1. Operation in excess of any one of these parameters may result in permanent damage.
 2. Mounted on 1.08cm² x 1.0 mm(t) glass epoxy PCB

ORDERING INFORMATION

PART NUMBER	QUANTITY	PACKAGING
UPA862TD-T3-A	10K Pcs./Reel	Tape & Reel

TYPICAL PERFORMANCE CURVES (T_A = 25°C)

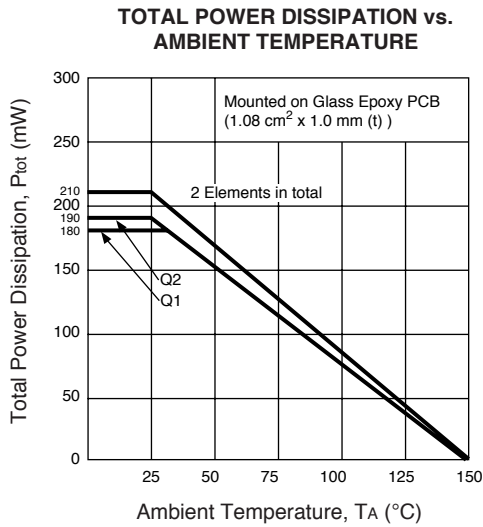

Q1

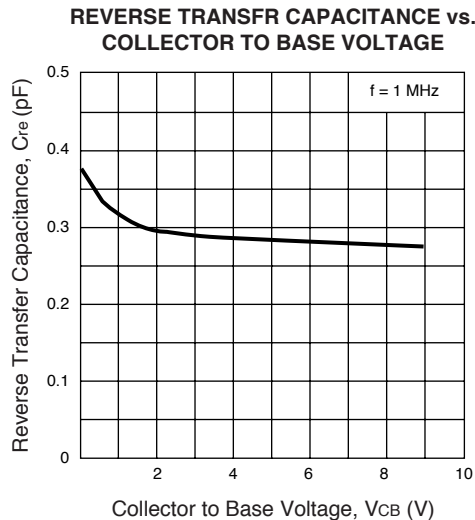

Q2

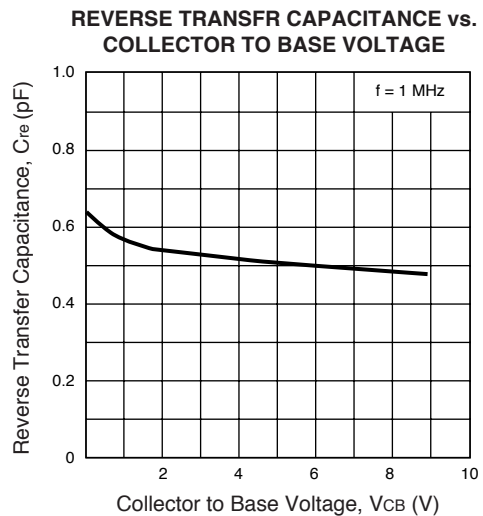

TYPICAL PERFORMANCE CURVES (TA = 25°C)

Q1

COLLECTOR CURRENT vs. BASE TO EMITTER VOLTAGE

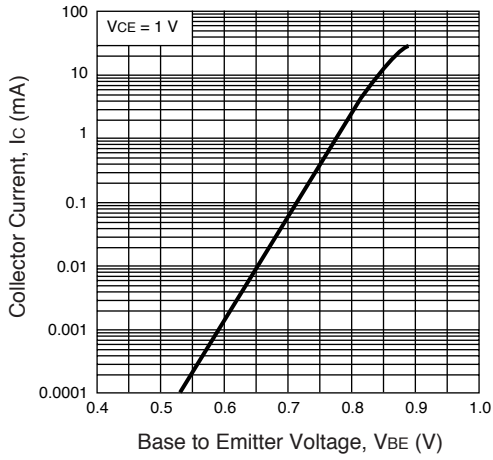

Q2

COLLECTOR CURRENT vs. BASE TO EMITTER VOLTAGE

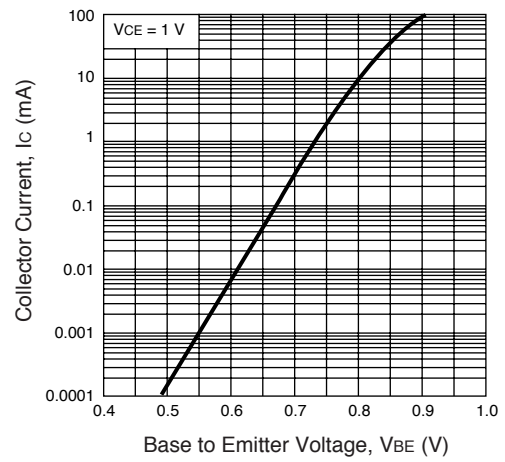

COLLECTOR CURRENT vs. BASE TO EMITTER VOLTAGE

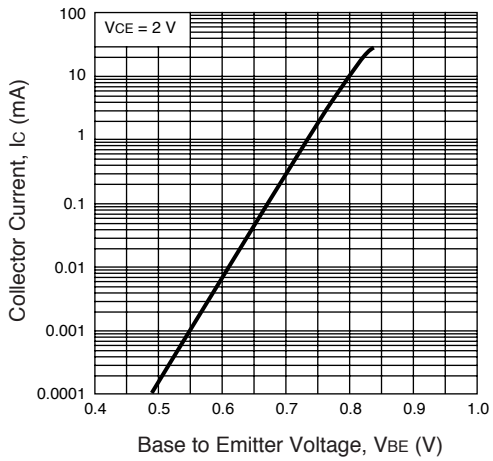

COLLECTOR CURRENT vs. BASE TO EMITTER VOLTAGE

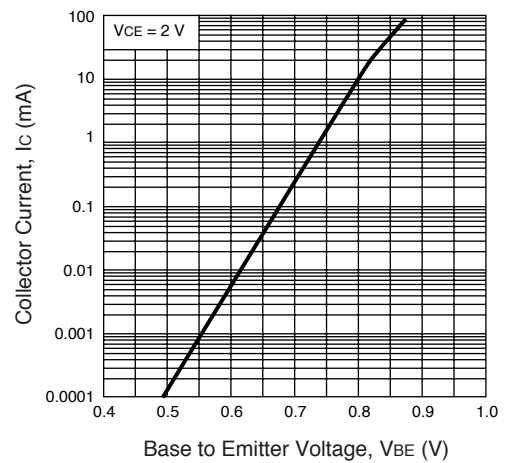

COLLECTOR CURRENT vs. COLLECTOR TO EMITTER VOLTAGE

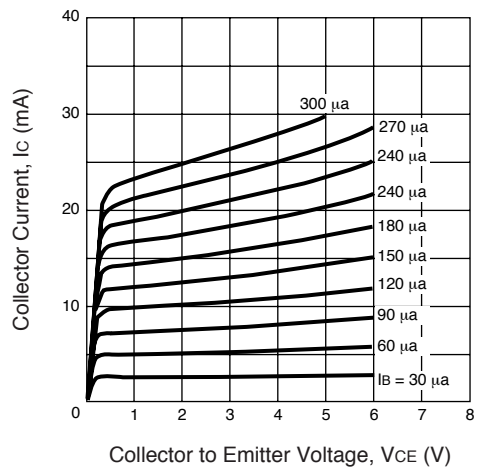

COLLECTOR CURRENT vs. COLLECTOR TO EMITTER VOLTAGE

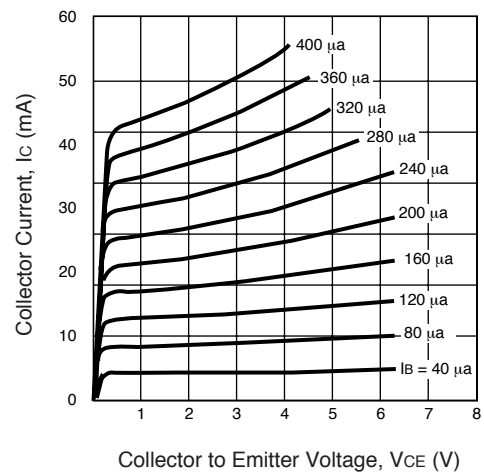

TYPICAL PERFORMANCE CURVES (T_A = 25°C)

Q1

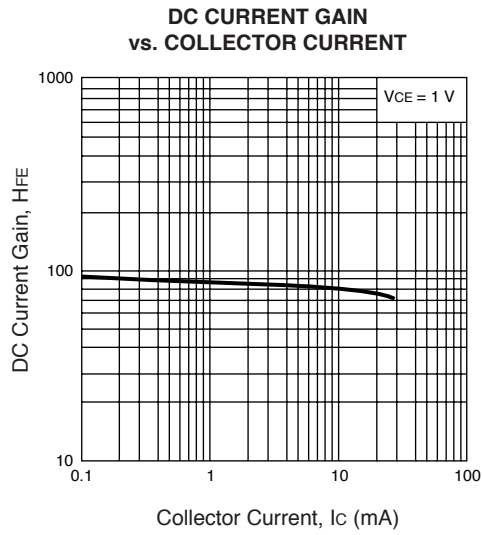

Q2

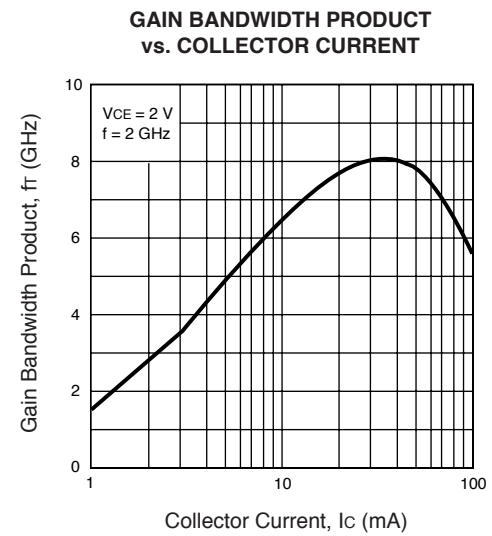
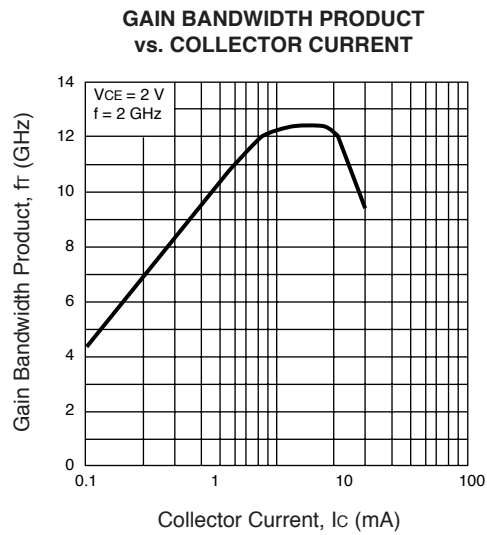
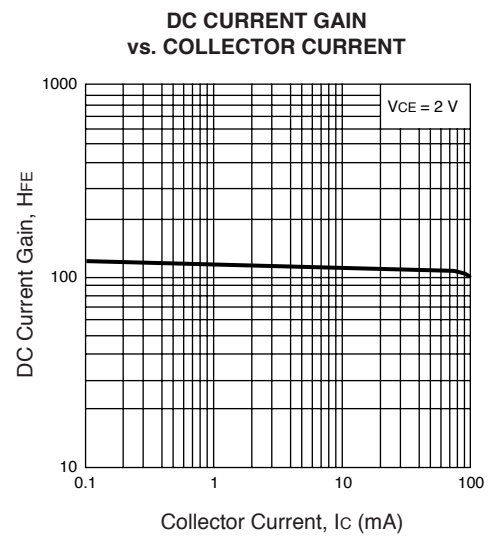
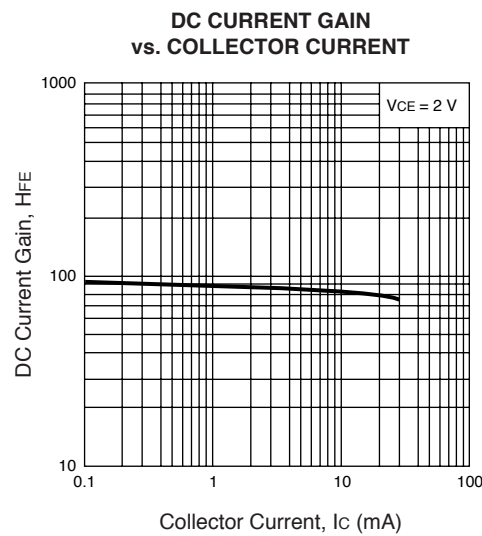
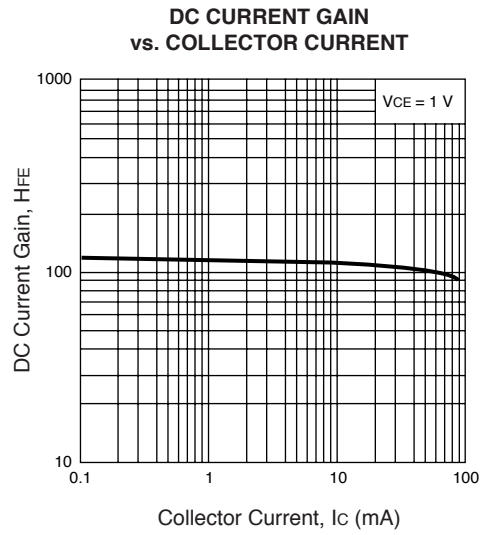

TYPICAL PERFORMANCE CURVES (TA = 25°C)

Q1

INSERTION POWER GAIN,
MAG, MSG vs. FREQUENCY

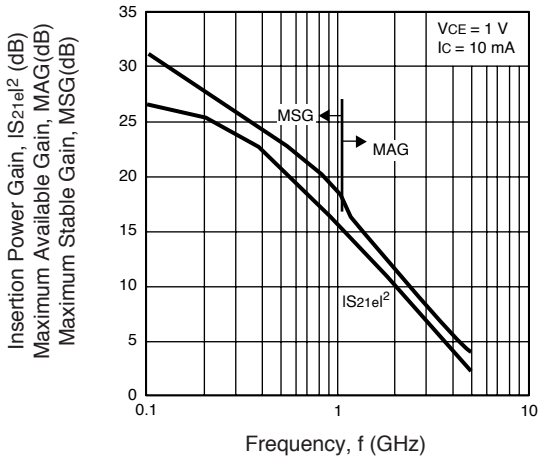

Q2

INSERTION POWER GAIN,
MAG, MSG vs. FREQUENCY

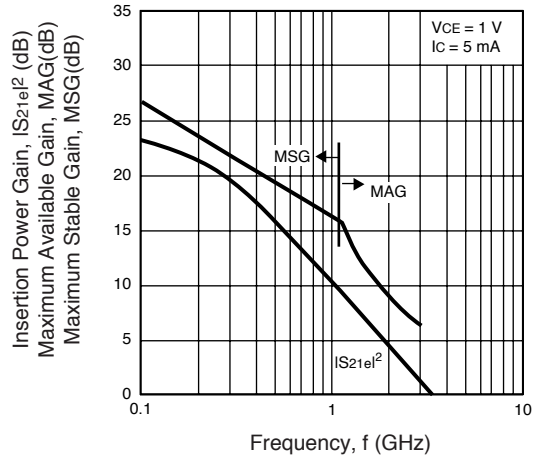

INSERTION POWER GAIN,
MAG, MSG vs. FREQUENCY

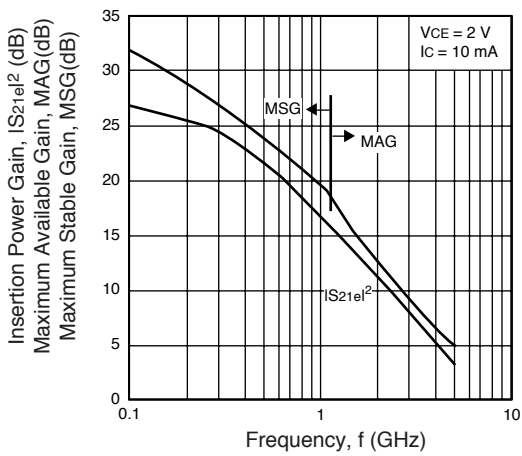

INSERTION POWER GAIN,
MAG, MSG vs. FREQUENCY

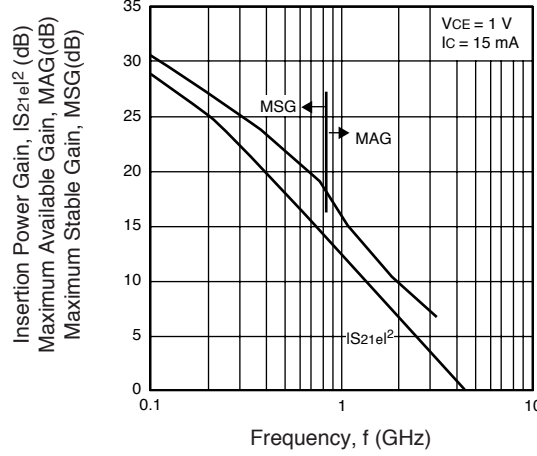

INSERTION POWER GAIN,
MAG, MSG vs. FREQUENCY

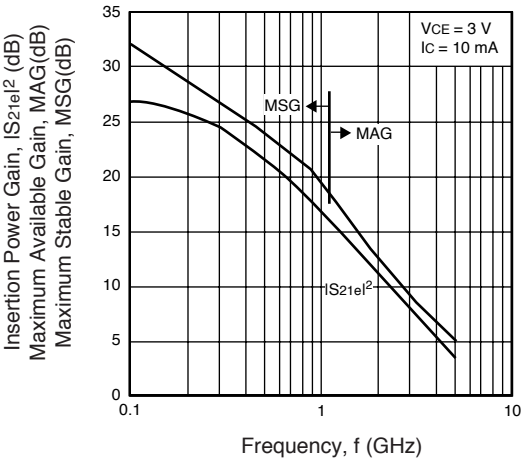

INSERTION POWER GAIN,
MAG, MSG vs. FREQUENCY

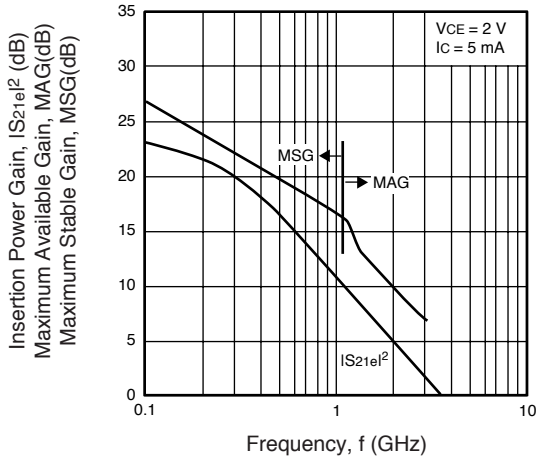

TYPICAL PERFORMANCE CURVES (TA = 25°C)

Q1

INSERTION POWER GAIN, MAG, MSG
vs. COLLECTOR CURRENT

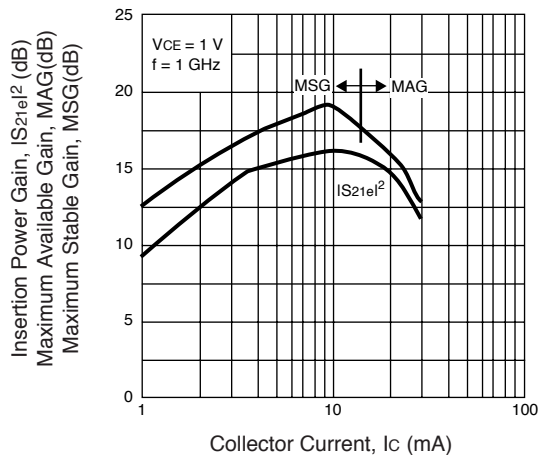

Q2

INSERTION POWER GAIN, MAG, MSG
vs. COLLECTOR CURRENT

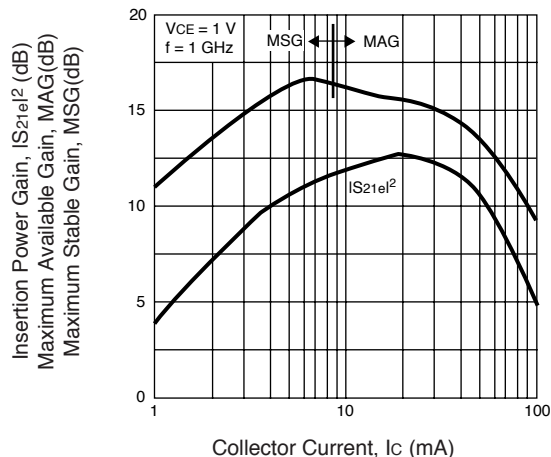

INSERTION POWER GAIN, MAG, MSG
vs. COLLECTOR CURRENT

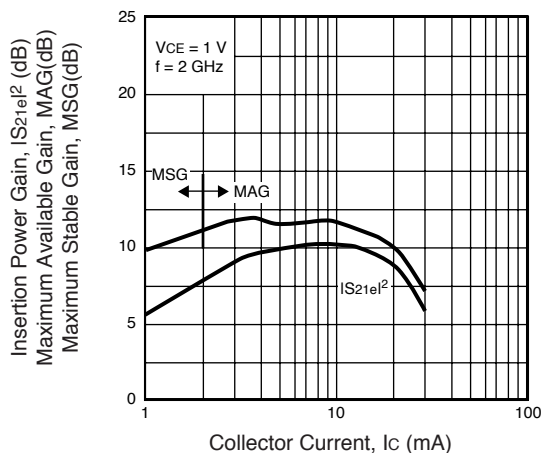

INSERTION POWER GAIN, MAG, MSG
vs. COLLECTOR CURRENT

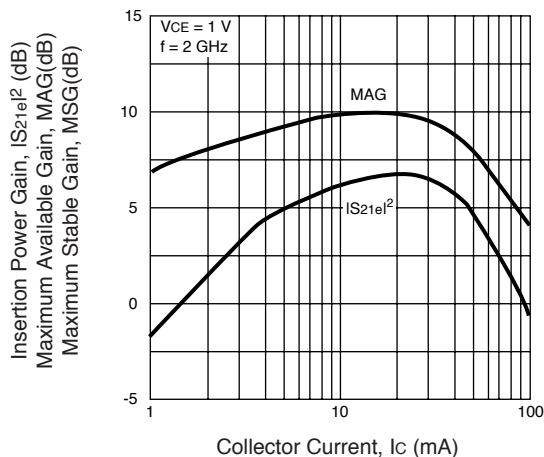

INSERTION POWER GAIN, MAG, MSG
vs. COLLECTOR CURRENT

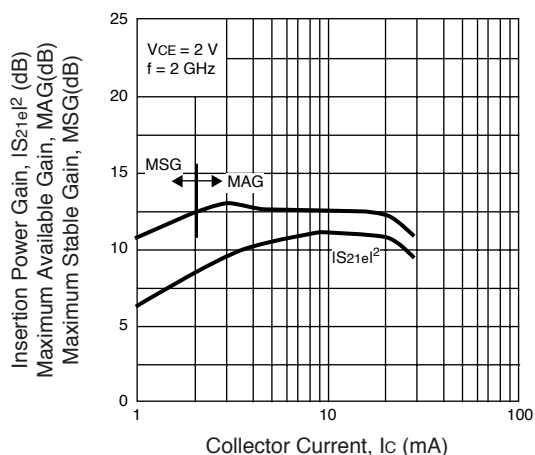

INSERTION POWER GAIN, MAG, MSG
vs. COLLECTOR CURRENT

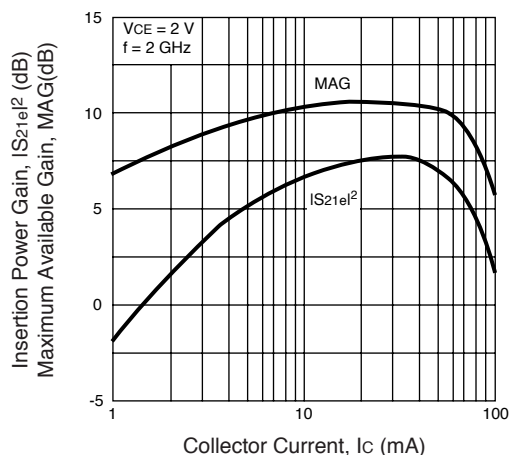

TYPICAL PERFORMANCE CURVES (TA = 25°C)

Q1

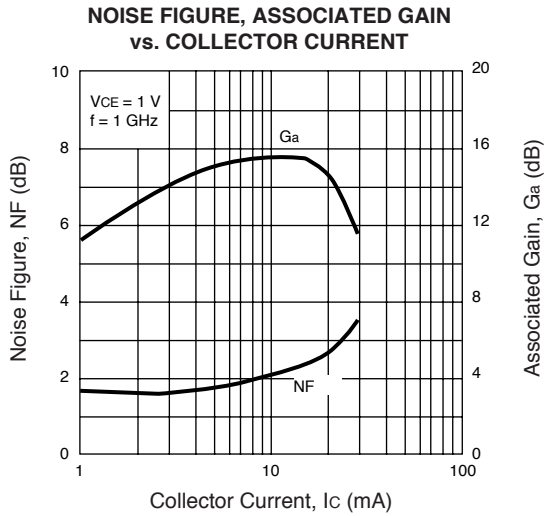

Q2

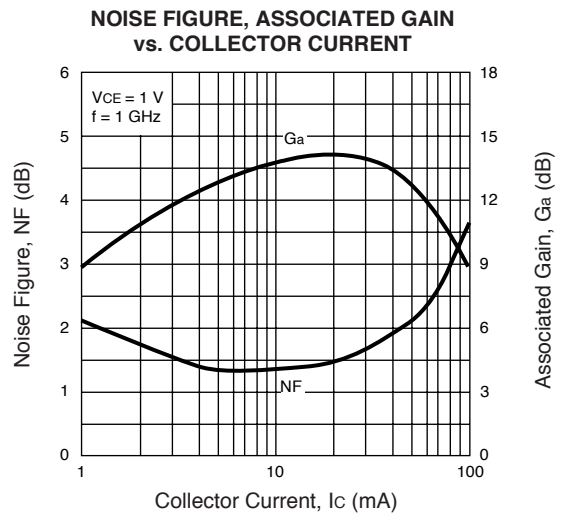

NOISE FIGURE, ASSOCIATED GAIN vs. COLLECTOR CURRENT

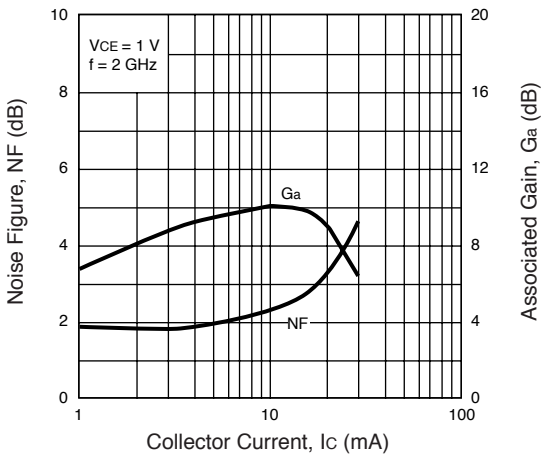

NOISE FIGURE, ASSOCIATED GAIN vs. COLLECTOR CURRENT

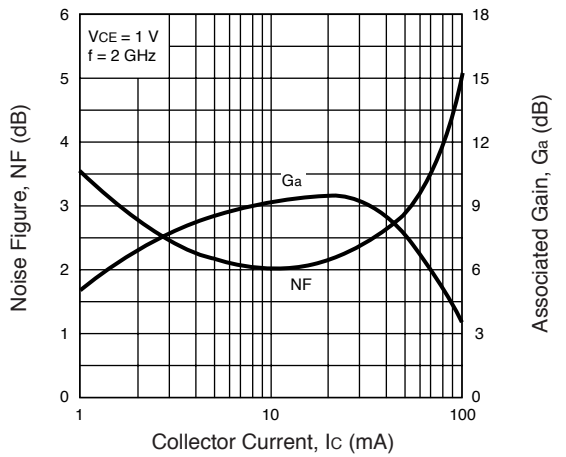

NOISE FIGURE, ASSOCIATED GAIN vs. COLLECTOR CURRENT

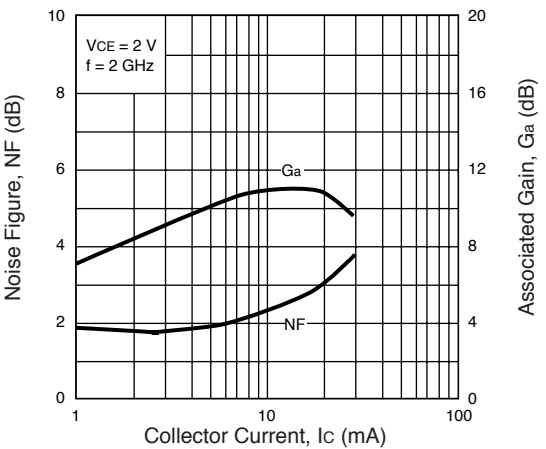

NOISE FIGURE, ASSOCIATED GAIN vs. COLLECTOR CURRENT

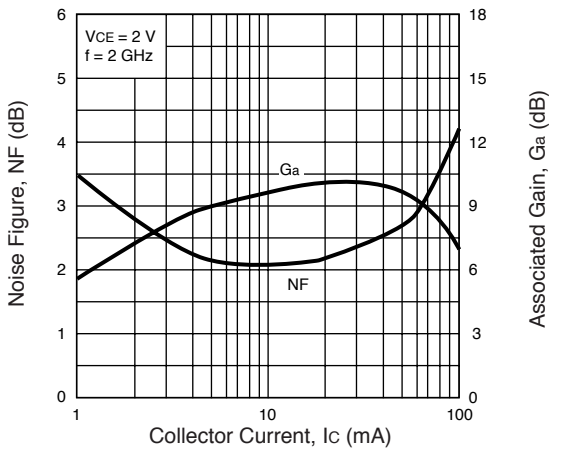

TYPICAL SCATTERING PARAMETERS

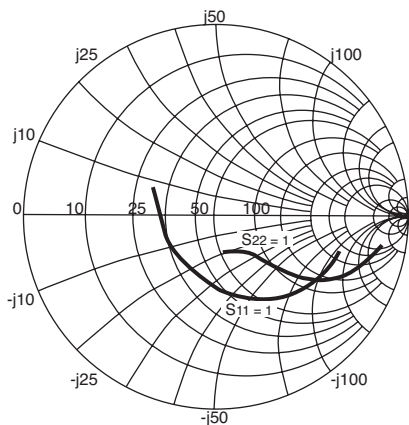

0.100 to 3.000GHz by 0.050

Coordinates in Ohms
Frequency in GHz
V_{CE} = 2.5 V, I_c = 10 mA

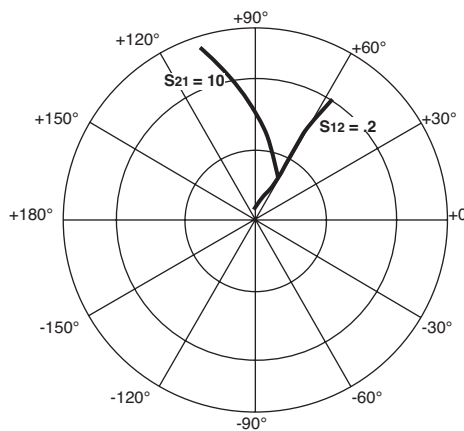

0.100 to 3.000GHz by 0.050

UPA82TD (Q1)

V_{CE} = 2.5V, I_c = 10 mA

Frequency GHz	S ₁₁		S ₂₁		S ₁₂		S ₂₂		K	MAG ¹ (dB)
	MAG	ANG	MAG	ANG	MAG	ANG	MAG	ANG		
0.10	0.726	-18.1	20.331	161.8	0.013	80.9	0.937	-11.7	0.21	31.83
0.20	0.667	-37.4	18.720	148.4	0.024	71.4	0.863	-21.2	0.30	28.89
0.30	0.594	-53.3	16.706	136.9	0.033	66.5	0.774	-28.1	0.39	27.06
0.40	0.521	-66.9	14.756	127.5	0.040	62.4	0.691	-33.1	0.50	25.69
0.50	0.459	-78.6	13.006	120.0	0.045	60.6	0.623	-36.3	0.58	24.56
0.60	0.408	-89.0	11.512	113.9	0.050	59.4	0.565	-38.6	0.66	23.59
0.70	0.366	-98.3	10.269	108.8	0.055	59.1	0.517	-40.0	0.73	22.70
0.80	0.334	-107.2	9.233	104.4	0.060	58.9	0.477	-41.0	0.79	21.91
0.90	0.310	-115.8	8.382	100.7	0.064	59.0	0.446	-41.9	0.84	21.18
1.00	0.292	-123.8	7.661	97.4	0.068	59.3	0.419	-42.5	0.88	20.50
1.10	0.282	-131.2	7.052	94.4	0.073	59.4	0.399	-43.3	0.92	19.86
1.20	0.273	-138.6	6.529	91.7	0.077	59.5	0.379	-44.0	0.95	19.28
1.30	0.268	-145.2	6.079	89.2	0.082	59.7	0.363	-45.1	0.97	18.71
1.40	0.266	-151.1	5.681	86.8	0.086	59.7	0.348	-46.2	0.99	18.18
1.50	0.264	-156.7	5.329	84.6	0.091	59.8	0.335	-47.6	1.01	17.15
1.60	0.264	-161.9	5.015	82.5	0.095	59.8	0.322	-48.7	1.03	16.18
1.70	0.265	-166.7	4.736	80.5	0.100	59.7	0.310	-50.1	1.04	15.48
1.80	0.267	-171.4	4.488	78.7	0.104	59.6	0.299	-51.5	1.06	14.87
1.90	0.270	-175.6	4.266	76.8	0.109	59.5	0.290	-53.0	1.07	14.33
2.00	0.276	-179.4	4.060	75.0	0.113	59.5	0.282	-54.6	1.08	13.84
2.10	0.282	177.1	3.878	73.3	0.118	59.2	0.274	-56.5	1.09	13.40
2.20	0.288	174.1	3.704	71.6	0.122	59.1	0.269	-58.7	1.09	12.97
2.30	0.295	171.4	3.556	70.0	0.127	58.8	0.264	-60.7	1.09	12.61
2.40	0.301	168.9	3.414	68.5	0.131	58.5	0.259	-63.0	1.10	12.24
2.50	0.307	166.8	3.283	66.9	0.136	58.1	0.256	-65.2	1.10	11.90
2.60	0.312	165.1	3.159	65.5	0.140	58.0	0.251	-67.5	1.11	11.55
2.70	0.316	163.4	3.049	64.1	0.144	57.8	0.248	-69.6	1.11	11.23
2.80	0.321	161.9	2.943	62.7	0.148	57.4	0.245	-71.6	1.12	10.91
2.90	0.325	160.2	2.848	61.3	0.153	57.1	0.243	-73.2	1.12	10.62
3.00	0.329	158.9	2.759	60.0	0.157	56.7	0.242	-75.0	1.12	10.35

Note:

1. Gain Calculations:

$$MAG = \frac{|S_{21}|}{|S_{12}|} (K \pm \sqrt{K^2 - 1})$$

. When $K \leq 1$, MAG is undefined and MSG values are used. $MSG = \frac{|S_{21}|}{|S_{12}|}$, $K = \frac{1 + |\Delta|^2 - |S_{11}|^2 - |S_{22}|^2}{2 |S_{12} S_{21}|}$, $\Delta = S_{11} S_{22} - S_{21} S_{12}$

MAG = Maximum Available Gain

MSG = Maximum Stable Gain

TYPICAL SCATTERING PARAMETERS

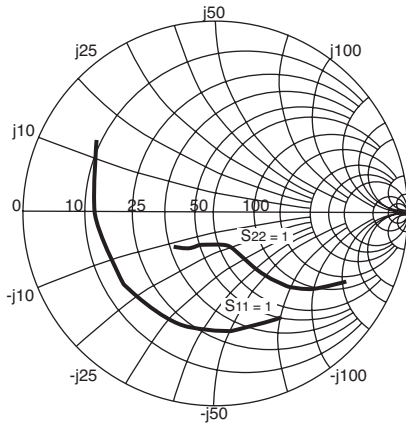

0.100 to 3.000GHz by 0.050

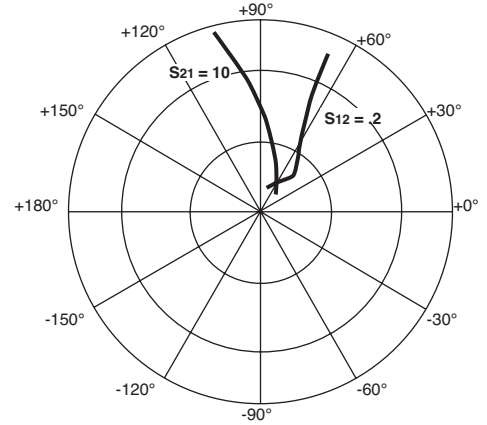

0.100 to 3.000GHz by 0.050

Coordinates in Ohms
Frequency in GHz
V_{CE} = 1 V, I_c = 10 mA

UPA862TD (Q2)

V_{CE} = 1 V, I_c = 10 mA

Frequency GHz	S ₁₁		S ₂₁		S ₁₂		S ₂₂		K	MAG ¹ (dB)
	MAG	ANG	MAG	ANG	MAG	ANG	MAG	ANG		
0.10	0.692	-58.7	20.972	144.3	0.028	61.7	0.800	-29.7	0.22	28.79
0.20	0.653	-100.9	16.060	123.6	0.041	48.9	0.599	-46.0	0.31	25.88
0.30	0.634	-124.2	12.209	111.1	0.048	44.0	0.465	-53.6	0.43	24.04
0.40	0.622	-139.2	9.673	102.9	0.053	42.6	0.382	-58.0	0.54	22.64
0.50	0.616	-149.4	7.951	96.9	0.056	42.9	0.329	-60.7	0.65	21.52
0.60	0.611	-157.1	6.721	92.2	0.059	44.5	0.291	-63.0	0.74	20.54
0.70	0.609	-163.3	5.816	88.1	0.063	46.1	0.264	-64.7	0.82	19.66
0.80	0.609	-168.2	5.118	84.6	0.067	47.9	0.243	-66.7	0.89	18.86
0.90	0.614	-172.5	4.573	81.4	0.070	49.8	0.229	-68.7	0.94	18.13
1.00	0.618	-176.2	4.134	78.5	0.074	51.6	0.218	-71.1	0.98	17.46
1.10	0.625	-179.4	3.774	75.7	0.078	53.1	0.212	-73.6	1.01	16.31
1.20	0.630	177.6	3.469	73.1	0.083	54.8	0.206	-76.7	1.03	15.12
1.30	0.634	175.0	3.210	70.5	0.088	56.0	0.204	-80.0	1.05	14.29
1.40	0.638	172.6	2.984	68.1	0.092	57.2	0.202	-83.6	1.07	13.53
1.50	0.641	170.5	2.788	65.8	0.097	58.2	0.203	-87.5	1.08	12.83
1.60	0.644	168.4	2.615	63.6	0.102	59.3	0.203	-91.2	1.10	12.21
1.70	0.647	166.5	2.462	61.4	0.107	60.3	0.204	-95.2	1.11	11.65
1.80	0.652	164.5	2.327	59.3	0.112	61.1	0.207	-99.0	1.11	11.16
1.90	0.657	162.8	2.207	57.3	0.118	61.8	0.211	-102.7	1.11	10.75
2.00	0.663	161.1	2.098	55.3	0.123	62.4	0.216	-106.1	1.10	10.42
2.10	0.670	159.5	2.000	53.4	0.129	62.9	0.222	-109.6	1.09	10.11
2.20	0.676	158.1	1.908	51.4	0.134	63.3	0.230	-112.7	1.08	9.85
2.30	0.683	156.8	1.827	49.6	0.140	63.7	0.239	-115.9	1.06	9.63
2.40	0.687	155.5	1.750	47.8	0.146	63.9	0.248	-119.0	1.05	9.39
2.50	0.692	154.5	1.679	46.1	0.152	64.2	0.258	-121.9	1.04	9.16
2.60	0.695	153.5	1.612	44.5	0.158	64.3	0.267	-124.6	1.03	8.95
2.70	0.698	152.6	1.554	42.9	0.165	64.5	0.277	-127.2	1.03	8.74
2.80	0.702	151.8	1.498	41.4	0.171	64.7	0.286	-129.7	1.02	8.62
2.90	0.706	150.8	1.448	40.0	0.178	64.7	0.294	-131.9	1.00	8.69
3.00	0.710	150.0	1.401	38.6	0.184	64.7	0.303	-133.8	0.99	8.81

UPA862TD NONLINEAR MODEL

BJT NONLINEAR MODEL PARAMETERS(1)

Parameters	Q1 NE685	Q2 NE851	Parameters	Q1 NE685	Q2 NE851
IS	7.0e-16	137e-18	MJC	0.34	0.14
BF	109	166	XCJC	0.5	0.5
NF	1	0.9871	CJS	0	0
VAF	15	20.4	VJS	0.75	0.75
IKF	0.19	50	MJS	0	0
ISE	7.90e-13	80.4e-15	FC	0.1	0.55
NE	2.19	2.4	TF	2.0e-12	18e-12
BR	1	28.7	XTF	6	0.1
NR	1.08	0.9889	VTF	3	2
VAR	12.4	2.7	ITF	0.005	0.03
IKR	infinity	0.021	PTF	0	0
ISC	0	532e-18	TR	1.0e-9	1.0e-9
NC	2	1.28	EG	1.11	1.11
RE	1.3	0.45	XTB	0	0
RB	5	4	XTI	3	3
RBM	3	1	KF (2)	0	0
IRB	0.005	0	AF (2)	1	1
RC	10	1.7			
CJE	0.4e-12	2.4e-12			
VJE	0.81	0.87			
MJE	0.5	0.34			
CJC	0.18e-12	0.65e-12			
VJC	0.75	0.52			

(1) Gummel-Poon Model

(2) AF and KF are 1/f noise parameters and are bias dependant. The appropriate values for the 1/f noise parameters (AF and KF) shall be chosen from the table below, according to the desired current range.

Q1		Ic = 5 mA	Ic =10 mA	Ic = 15 mA
	KF	54.38e-12	997.6e-12	500.2e-12
	AF	2.071	2.375	2.288

Q2		Ic = 5 mA	Ic =10 mA	Ic = 15 mA
	KF	4.547e-15	855e-12	1.73e-9
	AF	1.4	2.551	2.626

MODEL RANGE

Frequency: 0.1 to 3.0 GHz

Bias: V_{CE} =0.5 V to 2.5 V, I_c = 1 mA to 20 mA

Date: 08/03

For a better understanding on AF and KF parameters, please refer to AN1026.

SCHEMATIC

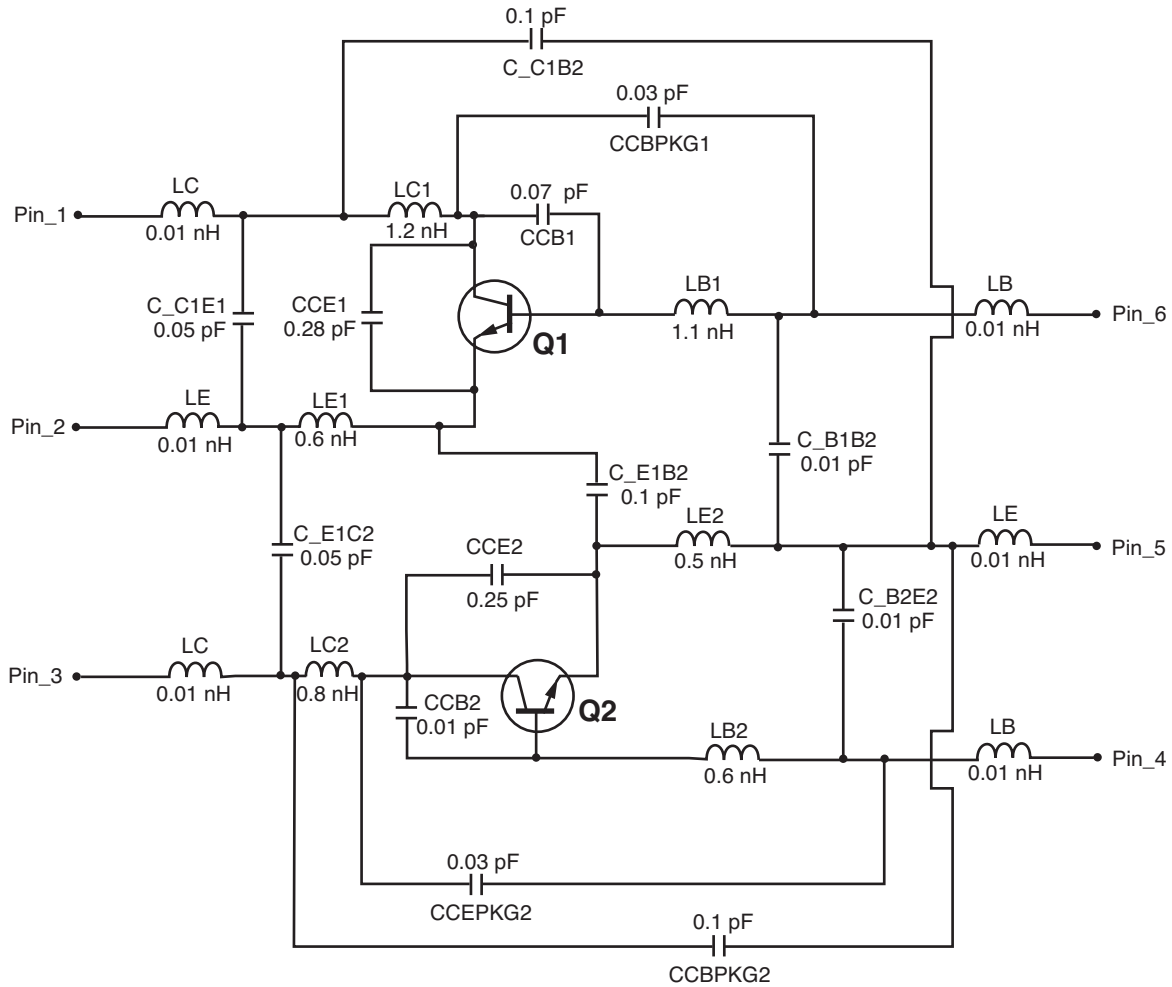

MODEL RANGE

Frequency: 0.1 to 3.0 GHz
 Bias: $V_{CE} = 0.5\text{ V to }2.5\text{ V}$, $I_c = 1\text{ mA to }20\text{ mA}$
 Date: 08/03

Life Support Applications

These NEC products are not intended for use in life support devices, appliances, or systems where the malfunction of these products can reasonably be expected to result in personal injury. The customers of CEL using or selling these products for use in such applications do so at their own risk and agree to fully indemnify CEL for all damages resulting from such improper use or sale.

CEL California Eastern Laboratories, Your source for NEC RF, Microwave, Optoelectronic, and Fiber Optic Semiconductor Devices.
 4590 Patrick Henry Drive • Santa Clara, CA 95054-1817 • (408) 988-3500 • FAX (408) 988-0279 • www.cel.com

DATA SUBJECT TO CHANGE WITHOUT NOTICE

08/04/2003

Subject: Compliance with EU Directives

CEL certifies, to its knowledge, that semiconductor and laser products detailed below are compliant with the requirements of European Union (EU) Directive 2002/95/EC Restriction on Use of Hazardous Substances in electrical and electronic equipment (RoHS) and the requirements of EU Directive 2003/11/EC Restriction on Penta and Octa BDE.

CEL Pb-free products have the same base part number with a suffix added. The suffix –A indicates that the device is Pb-free. The –AZ suffix is used to designate devices containing Pb which are exempted from the requirement of RoHS directive (*). In all cases the devices have Pb-free terminals. All devices with these suffixes meet the requirements of the RoHS directive.

This status is based on CEL’s understanding of the EU Directives and knowledge of the materials that go into its products as of the date of disclosure of this information.

Restricted Substance per RoHS	Concentration Limit per RoHS (values are not yet fixed)	Concentration contained in CEL devices	
		-A	-AZ
Lead (Pb)	< 1000 PPM	Not Detected	(*)
Mercury	< 1000 PPM	Not Detected	
Cadmium	< 100 PPM	Not Detected	
Hexavalent Chromium	< 1000 PPM	Not Detected	
PBB	< 1000 PPM	Not Detected	
PBDE	< 1000 PPM	Not Detected	

If you should have any additional questions regarding our devices and compliance to environmental standards, please do not hesitate to contact your local representative.

Important Information and Disclaimer: Information provided by CEL on its website or in other communications concerning the substance content of its products represents knowledge and belief as of the date that it is provided. CEL bases its knowledge and belief on information provided by third parties and makes no representation or warranty as to the accuracy of such information. Efforts are underway to better integrate information from third parties. CEL has taken and continues to take reasonable steps to provide representative and accurate information but may not have conducted destructive testing or chemical analysis on incoming materials and chemicals. CEL and CEL suppliers consider certain information to be proprietary, and thus CAS numbers and other limited information may not be available for release.

In no event shall CEL’s liability arising out of such information exceed the total purchase price of the CEL part(s) at issue sold by CEL to customer on an annual basis.

See CEL Terms and Conditions for additional clarification of warranties and liability.