



# Balun Transformers

Wound SMD

## ATB series

---

**ATB3225-75011CT (3.2×2.5×2.3mm)**

**ATB3225-75032CT (3.2×2.5×2.3mm)**

**ATB3225-75034CT (3.2×2.5×2.3mm)**

---

## REMINDERS FOR USING THESE PRODUCTS

Before using these products, be sure to request the delivery specifications.

### SAFETY REMINDERS

Please pay sufficient attention to the warnings for safe designing when using these products.

#### REMINDERS

- The storage period is less than 6 months. Be sure to follow the storage conditions (Temperature: 5 to 40°C, Humidity: 10 to 75% RH or less).  
If the storage period elapses, the soldering of the terminal electrodes may deteriorate.
- Do not use or store in locations where there are conditions such as gas corrosion (salt, acid, alkali, etc.).
- Before soldering, be sure to preheat components.  
The preheating temperature should be set so that the temperature difference between the solder temperature and chip temperature does not exceed 150°C.
- Soldering corrections after mounting should be within the range of the conditions determined in the specifications.  
If overheated, a short circuit, performance deterioration, or lifespan shortening may occur.
- When embedding a printed circuit board where a chip is mounted to a set, be sure that residual stress is not given to the chip due to the overall distortion of the printed circuit board and partial distortion such as at screw tightening portions.
- Self heating (temperature increase) occurs when the power is turned ON, so the tolerance should be sufficient for the set thermal design.
- Carefully lay out the coil for the circuit board design of the non-magnetic shield type.  
A malfunction may occur due to magnetic interference.
- Use a wrist band to discharge static electricity in your body through the grounding wire.
- Do not expose the products to magnets or magnetic fields.
- Do not use for a purpose outside of the contents regulated in the delivery specifications.
- The products listed on this catalog are intended for use in general electronic equipment (AV equipment, telecommunications equipment, home appliances, amusement equipment, computer equipment, personal equipment, office equipment, measurement equipment, industrial robots) under a normal operation and use condition.  
The products are not designed or warranted to meet the requirements of the applications listed below, whose performance and/or quality require a more stringent level of safety or reliability, or whose failure, malfunction or trouble could cause serious damage to society, person or property.  
If you intend to use the products in the applications listed below or if you have special requirements exceeding the range or conditions set forth in the each catalog, please contact us.

- (1) Aerospace/Aviation equipment
- (2) Transportation equipment (cars, electric trains, ships, etc.)
- (3) Medical equipment
- (4) Power-generation control equipment
- (5) Atomic energy-related equipment
- (6) Seabed equipment
- (7) Transportation control equipment

- (8) Public information-processing equipment
- (9) Military equipment
- (10) Electric heating apparatus, burning equipment
- (11) Disaster prevention/crime prevention equipment
- (12) Safety equipment
- (13) Other applications that are not considered general-purpose applications

When designing your equipment even for general-purpose applications, you are kindly requested to take into consideration securing protection circuit/device or providing backup circuits in your equipment.

# Balun Transformers

## Wound SMD

Halogen-free  
Compatible with lead-free solders

# Overview of the ATB Series

## FEATURES

- The ATB3225 case size is L3.2×W2.5×H2.3mm.
- The case size is smaller than conventional baluns.
- The frequency band width for ATB3225-75011CT is 5 to 200MHz, for ATB3225-75032CT is 5 to 100MHz, and for ATB3225-75034CT is 1 to 100MHz.
- Low insertion loss and good balance parameters.
- Conforms to the RoHS Directive.

## APPLICATION

Cable modem

## PART NUMBER CONSTRUCTION

ATB	3225	-	750	11	CT	-	T	000
Series name	LxWxH Dimensions (mm)	Impedance (Ω) at 100MHz	Impedance ratio		Type	Packaging style	Internal code	
	3.2x2.5x2.3	750   75	11   1:1	32   3:2	CT   Center tap	T   ø180mm reel	TL   ø330mm reel	
			34   3:4					

## OPERATING TEMPERATURE RANGE, PACKAGE QUANTITY, PRODUCT WEIGHT

Type	Temperature range		Reel diameter	Package quantity	Individual weight
	Operating temperature*	Storage temperature**			
	(°C)	(°C)		(pieces/reel)	(mg)
ATB3225-75011CT	-25 to +85	-25 to +85	ø180mm	2,000	75
			ø330mm	10,000	
ATB3225-75032CT	-25 to +85	-25 to +85	ø180mm	2,000	75
			ø330mm	10,000	
ATB3225-75034CT	-25 to +85	-25 to +85	ø180mm	2,000	75
			ø330mm	10,000	

\* Operating temperature range includes self-temperature rise.

\*\* The Storage temperature range is for after the circuit board is mounted.

○ Halogen-free: Indicates that Cl content is less than 900ppm, Br content is less than 900ppm, and that the total Cl and Br content is less than 1500ppm.

• All specifications are subject to change without notice.

# Overview of the ATB Series

## RECOMMENDED REFLOW PROFILE



Preheating			Soldering		Peak	
Temp.	Temp.	Time	Temp.	Time	Temp.	Time
T1	T2	t1	T3	t2	T4	t3
150°C	180°C	60 to 120s	230°C	10 to 30s	245°C	5s max.

ATB series

# ATB3225-75011CT Type



## SHAPE & DIMENSIONS

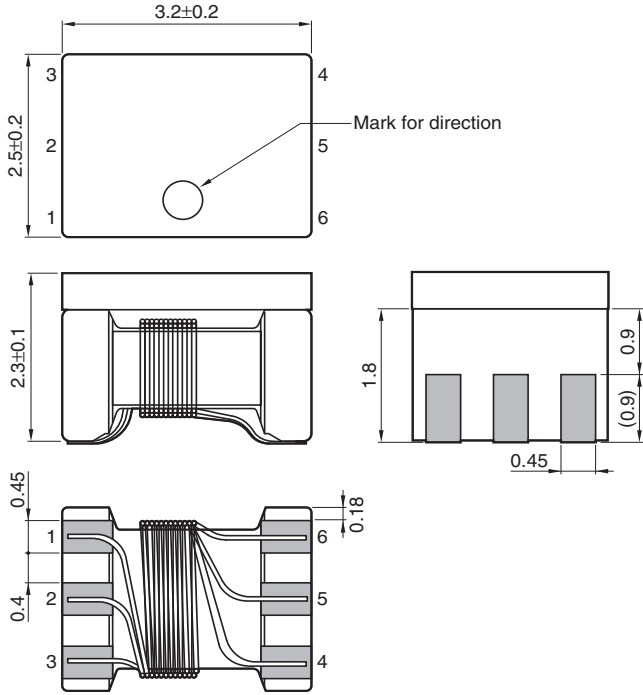

Dimensions in mm

## RECOMMENDED LAND PATTERN

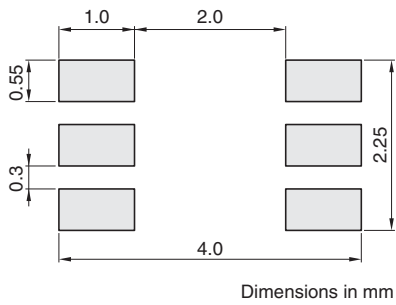

Dimensions in mm

## CIRCUIT DIAGRAM

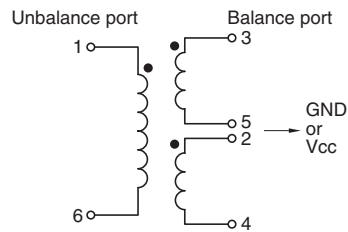

• All specifications are subject to change without notice.

# ATB series ATB3225-75011CT Type

## ELECTRICAL CHARACTERISTICS

### CHARACTERISTICS SPECIFICATION TABLE

DC resistance ( $\Omega$ )max.	Impedance ratio	Frequency range (MHz)	Insertion loss (dB)max.	Return loss (dB)min.	Amplitude unbalance (dB)max.	Phase unbalance (deg.)	Part No.*
0.7	1:1 (75 $\Omega$ :75 $\Omega$ )	5 to 65	0.8	15	0.1	180 $\pm$ 2	ATB3225-75011CT-□000
		5 to 200	0.5	10	0.5	180 $\pm$ 5	

\* □ : Includes packaging style indication (T:  $\phi$ 180mm reel, TL:  $\phi$ 330mm reel).

### Measurement equipment

Measurement item	Product No.	Manufacturer
Insertion loss	E5071B	Agilent Technologies
Return loss	E5071B	Agilent Technologies
Amplitude unbalance	E5071B	Agilent Technologies
Phase unbalance	E5071B	Agilent Technologies

\* Equivalent measurement equipment may be used.

## FREQUENCY CHARACTERISTICS

### INSERTION LOSS

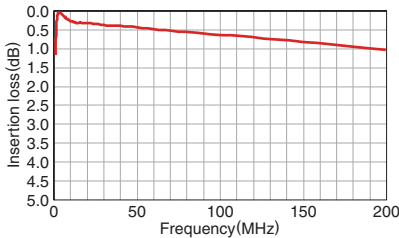

### RETURN LOSS

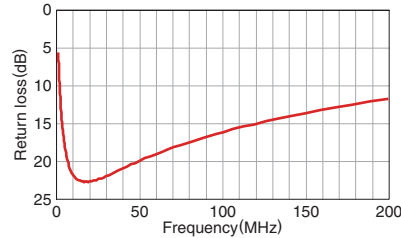

### AMPLITUDE UNBALANCE

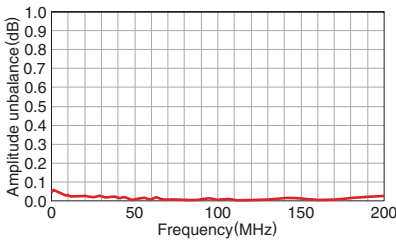

### PHASE UNBALANCE

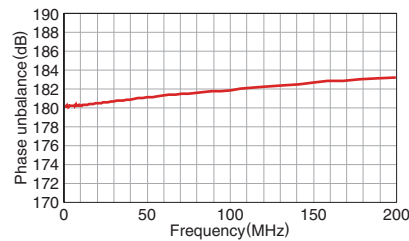

• All specifications are subject to change without notice.

ATB series

# ATB3225-75032CT Type



### SHAPE & DIMENSIONS

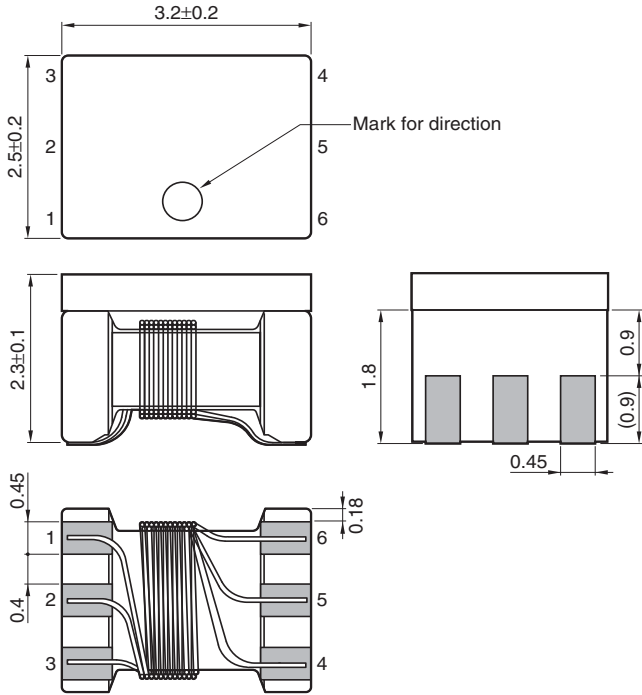

Dimensions in mm

### RECOMMENDED LAND PATTERN

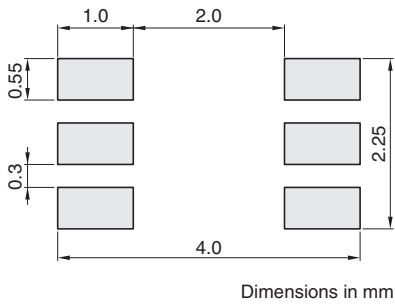

Dimensions in mm

### CIRCUIT DIAGRAM

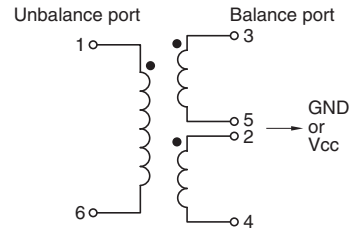

• All specifications are subject to change without notice.

# ATB series ATB3225-75032CT Type

## ELECTRICAL CHARACTERISTICS

### CHARACTERISTICS SPECIFICATION TABLE

DC resistance (Ω)max.	Impedance ratio	Frequency range (MHz)	Insertion loss (dB)max.	Return loss (dB)min.	Amplitude unbalance (dB)max.	Phase unbalance (deg.)	Part No.*
0.7	3:2 (75Ω:50Ω)	5 to 100	2	5	1	180±10	ATB3225-75032CT-□000

\* □ : Includes packaging style indication (T: ø180mm reel, TL: ø330mm reel).

### Measurement equipment

Measurement item	Product No.	Manufacturer
Insertion loss	E5071B	Agilent Technologies
Return loss	E5071B	Agilent Technologies
Amplitude unbalance	E5071B	Agilent Technologies
Phase unbalance	E5071B	Agilent Technologies

\* Equivalent measurement equipment may be used.

## FREQUENCY CHARACTERISTICS

### INSERTION LOSS

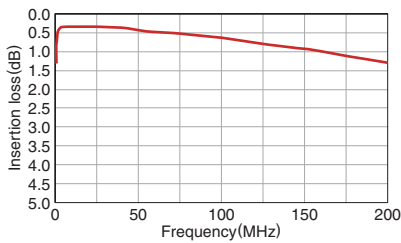

### RETURN LOSS

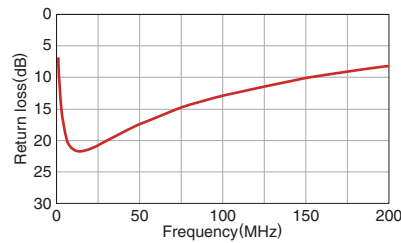

### AMPLITUDE BALANCE

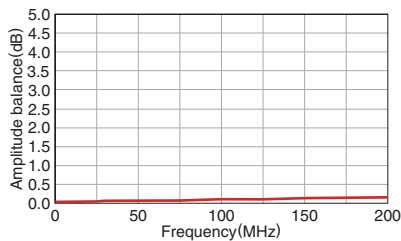

### PHASE BALANCE

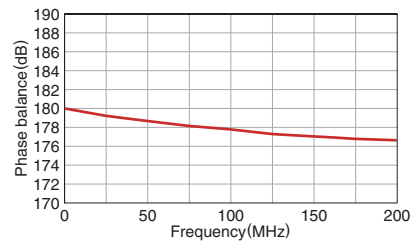

• All specifications are subject to change without notice.



ATB series

# ATB3225-75034CT Type



## SHAPE & DIMENSIONS

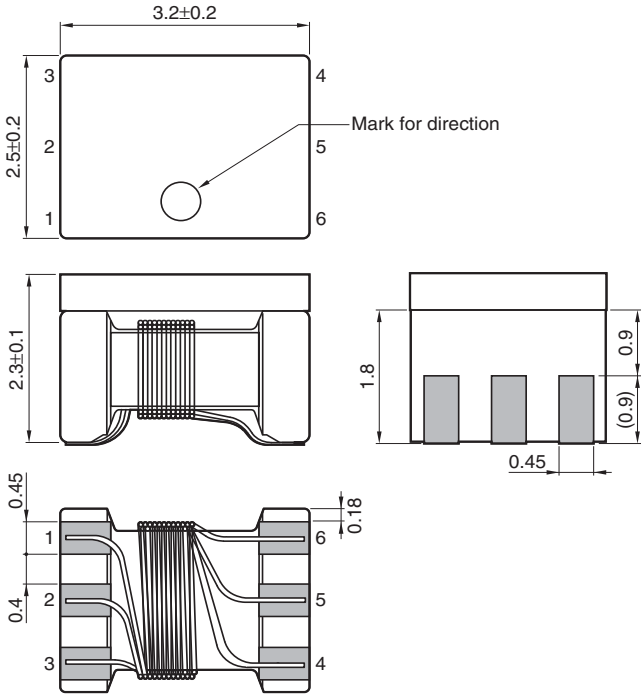

Dimensions in mm

## RECOMMENDED LAND PATTERN

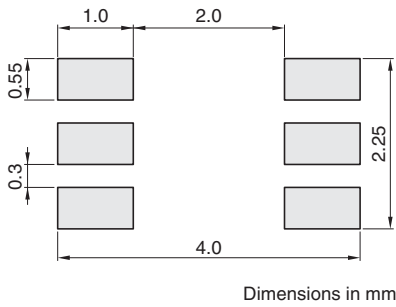

Dimensions in mm

## CIRCUIT DIAGRAM

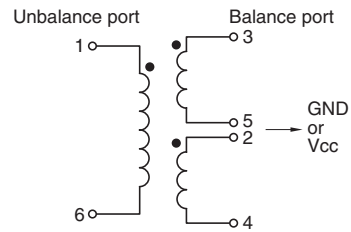

• All specifications are subject to change without notice.

# ATB series ATB3225-75034CT Type

## ELECTRICAL CHARACTERISTICS

### CHARACTERISTICS SPECIFICATION TABLE

DC resistance ( $\Omega$ )max.	Impedance ratio	Frequency range (MHz)	Insertion loss (dB)max.	Return loss (dB)min.	Amplitude unbalance (dB)max.	Phase unbalance (deg.)	Part No.*
0.7	3:4 (75 $\Omega$ :100 $\Omega$ )	1 to 100	2	5	0.1	180 $\pm$ 10	ATB3225-75034CT-□000

\* □ : Includes packaging style indication (T:  $\phi$ 180mm reel, TL:  $\phi$ 330mm reel).

### Measurement equipment

Measurement item	Product No.	Manufacturer
Insertion loss	E5071B	Agilent Technologies
Return loss	E5071B	Agilent Technologies
Amplitude unbalance	E5071B	Agilent Technologies
Phase unbalance	E5071B	Agilent Technologies

\* Equivalent measurement equipment may be used.

## FREQUENCY CHARACTERISTICS

### INSERTION LOSS

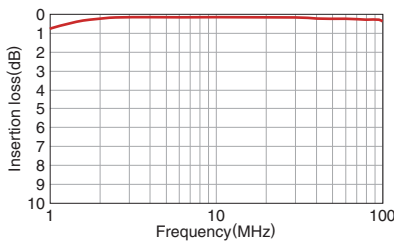

### RETURN LOSS

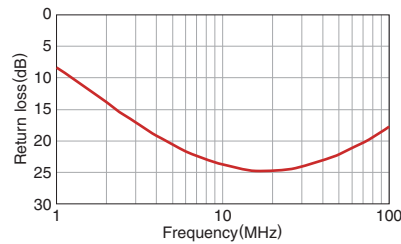

### AMPLITUDE IMBALANCE

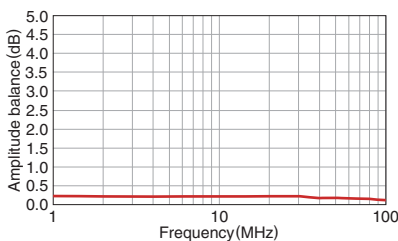

### PHASE BALANCE

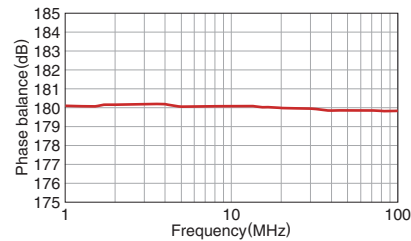

• All specifications are subject to change without notice.

ATB series

# Packaging style

## REEL DIMENSIONS

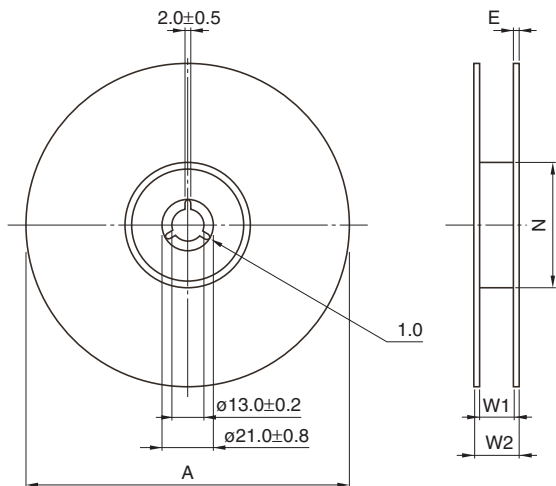

Dimensions in mm

Type	A	W1	W2	N	E
ATB3225-75011CT	ø180+0/-1.5	9+1/-0	13±1	60+1/-0	2 typ.
ATB3225-75032CT	ø180+0/-1.5	9+1/-0	13±1	60+1/-0	2 typ.
ATB3225-75034CT	ø180+0/-1.5	9+1/-0	13±1	60+1/-0	2 typ.

## TAPE DIMENSIONS

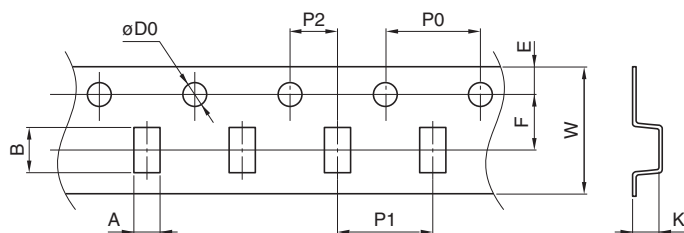

Dimensions in mm

Type	A	B	øD0	E	F	P0	P1	P2	W	K
ATB3225-75011CT	2.9±0.1	3.6±0.1	1.5+0.1/0	1.75±0.1	3.5±0.05	4.0±0.1	4.0±0.1	2.0±0.05	8.0±0.2	2.5±0.05
ATB3225-75032CT	2.9±0.1	3.6±0.1	1.5+0.1/0	1.75±0.1	3.5±0.05	4.0±0.1	4.0±0.1	2.0±0.05	8.0±0.2	2.5±0.05
ATB3225-75034CT	2.9±0.1	3.6±0.1	1.5+0.1/0	1.75±0.1	3.5±0.05	4.0±0.1	4.0±0.1	2.0±0.05	8.0±0.2	2.5±0.05

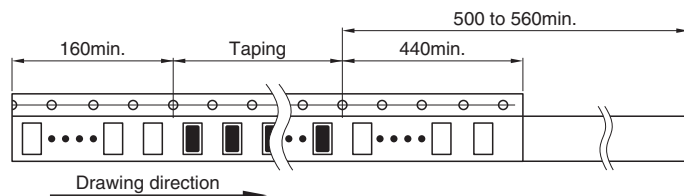

Dimensions in mm

• All specifications are subject to change without notice.

# Mouser Electronics

Authorized Distributor

Click to View Pricing, Inventory, Delivery & Lifecycle Information:

[TDK:](#)

[ATB3225-75011CT](#)