

1 2 3 4 5 6 7

A

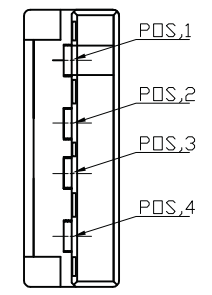
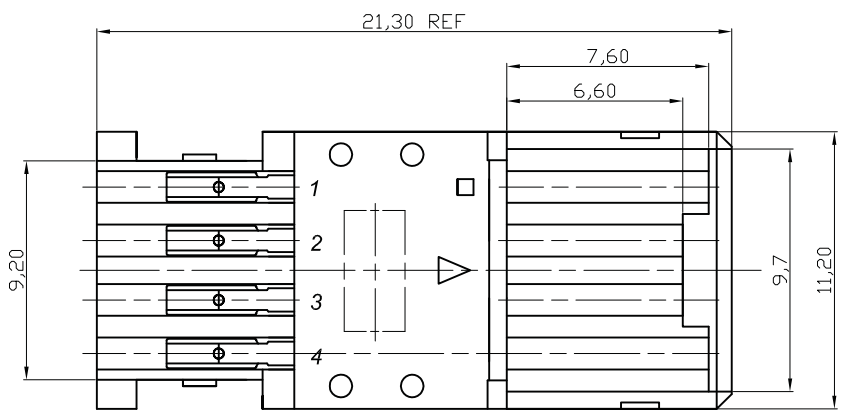
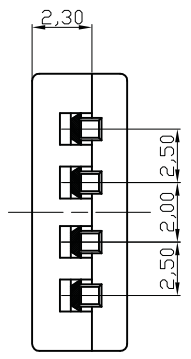

B

C

D

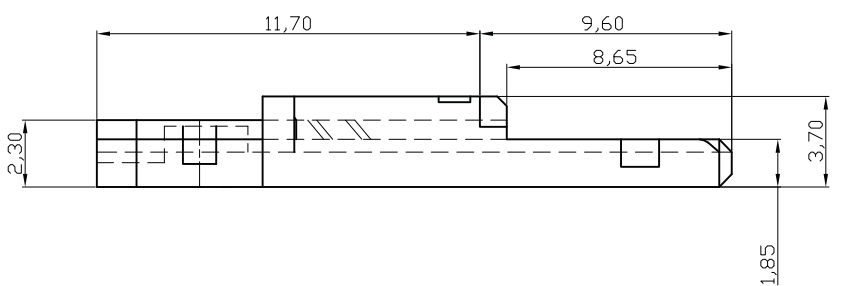

NOTE:
 1.MATERIALS:
 INSULATION:PBT WITH 30%GLASS FILLED , UL94V-0 RADTED
 COLOR:WHITE
 CONTACT:COPPER ALLOY
 PLATING 30µ" GOLD

E

F

G

Unit: mm



Scale	Free					Date	Name	Title	
TOLERANCE						Drawn	10.04.12	Miller	ASSMANN WSW-No. A-USBPA-2-R
.XX	±0.10					Approved	12.02.13	Groll	
.X	±0.20								Drawing-No.
X.	±0.50								rev01
XX.	±1								
DIM	TOL								Sheet 1/4
		①	Tooling modification	12.02.13	Wilson	 1840 W. Drake Drive, Suite 101 • Tempe, AZ 85283 Toll Free: 1-877-277-6266 • Email: info@assmann.us			
Angle	TOL	Id.	Modification	Date	Name			Replace	

H

1 2 3 4 5 6 7

1

2

3

4

5

6

7

A

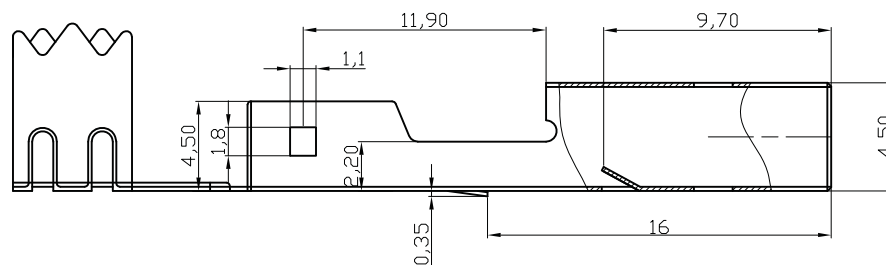
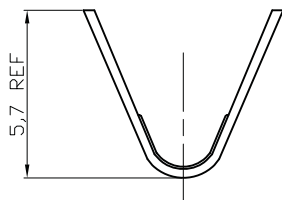

SECTION A-A

B

B

C

NOTE:

1.0.MATERIALS:

1.1.COLD ROLL STEEL. t=0.35mm

2.0.FINISHES:

2.1.5.0um Min.BRIGHT TIN/LEAD(9:1) OVER 5.0um Min.COPPER

2.2.3.0um-5.0um NICKEL OVER 5.0um Min.COPPER

2.3.1.5u" Min.Au+80~150U".NICKEL+100U"Min.COPPER

2.4.3.0um-5.0um NICKEL OVER 5.0um Min.COPPER(SPECIAL PLATED)

④ 3.0. APPLICATION CABLE SPEC:

UL CSA Type	AWG Signal wires Power wires	Jacket OD.	Cable length(max.)
UL CM UL FT4	28AWG x 1T.P. 28AWG x 2Cores	4.2mm	0.81m
	28AWG x 1T.P. 26AWG x 2Cores	4.4mm	1.31m
	28AWG x 1T.P. 24AWG x 2Cores	4.7mm	2.08m
	28AWG x 1T.P. 22AWG x 2Cores	5.0mm	3.33m
	28AWG x 1T.P. 20AWG x 2Cores	5.0mm	5.00m

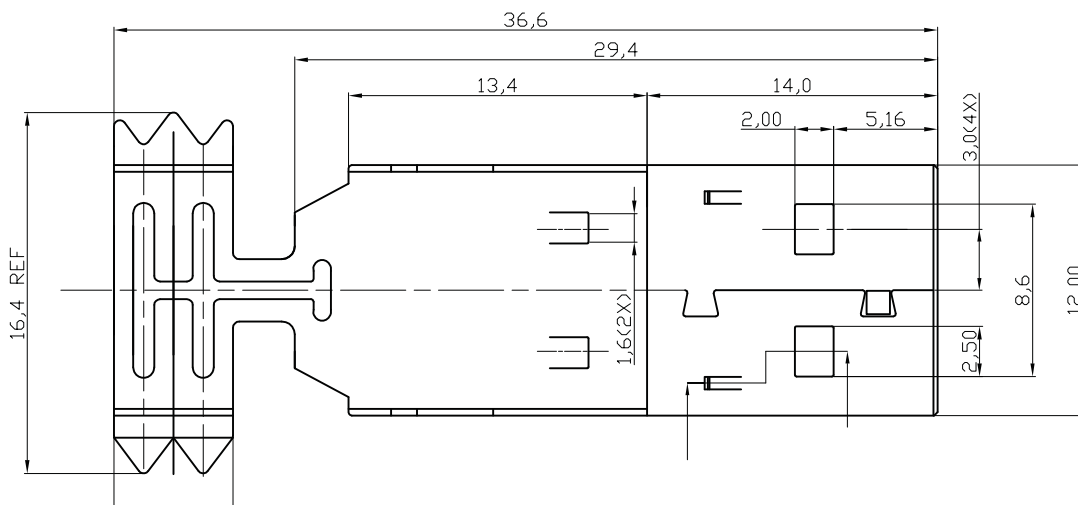

E

E

F

F

G

G

Unit: mm



Scale	Free				Date	Name	Title
TOLERANCE					Drawn	10.04.12	Miller
.XX	±0.10				Approved	12.02.13	Groll
.X	±0.20						
X.	±0.50						
XX.	±1						
DIM	TOL						
		①	Tooling modification	12.02.13	Wilson		
Angle	TOL	Id.	Modification	Date	Name		

ASSMANN
WSW components

1840 W. Drake Drive, Suite 101 • Tempe, AZ 85283
Toll Free: 1-877-277-6266 • Email: info@assmann.us

ASSMANN WSW-No.		rev01
A-USBPA-2-R		
Drawing-No.		Sheet 2/4
Replace		

1

2

3

4

5

6

7

H

H

1

2

3

4

5

6

7

A

B

C

D

E

F

G

H

A

B

C

D

E

F

G

H

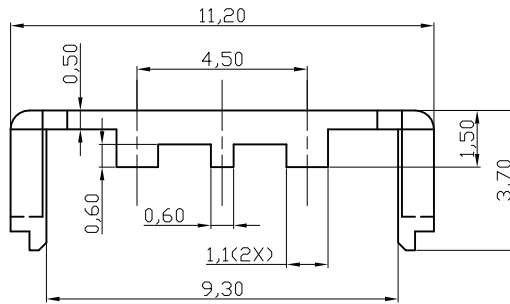
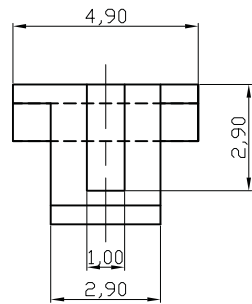
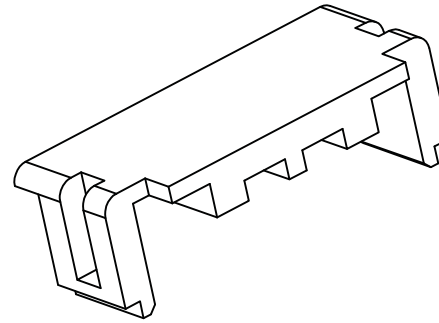
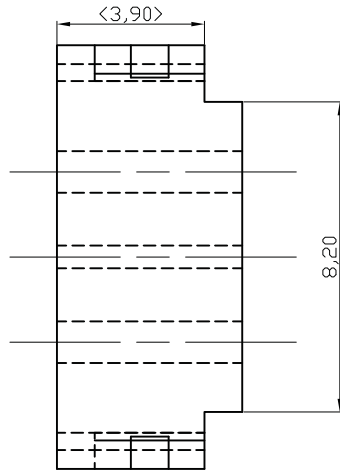

NOTE:

1.MATERIAL:PBT WITH 30%GLASS FILLED,UL 90V-0 RATED

Unit: mm



Scale	Free					Date	Name	Title
TOLERANCE						Drawn	10.04.12	Miller
.XX	± 0.10					Approved	12.02.13	Groll
.X	± 0.20							
X.	± 0.50							
XX.	± 1							
DIM	TOL							
		①	Tooling modification	12.02.13	Wilson			
		①	Modification	Date	Name			
Angle	TOL	Id.				1840 W. Drake Drive, Suite 101 • Tempe, AZ 85283 Toll Free: 1-877-277-6266 • Email: info@assmann.us		

ASSMANN WSW-No.		rev01
A-USBPA-2-R		
Drawing-No.		Sheet 3/4
Replace		

1

2

3

4

5

6

7

1

2

3

4

5

6

7

A

A

B

B

C

C

D

D

E

E

F

F

G

G

H

H

VIEW A

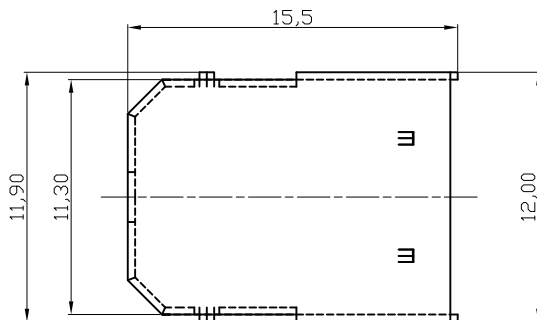
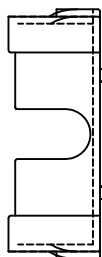

NOTE:

1.0.MATERIALS:

1.1.COLD ROLL STEEL. t=0.35mm

2.0.FINISHES:

2.1.5.0um Min.BRIGHT TIN/LEAD(9:1) OVER 5.0um Min.COPPER

2.2.3.0um-5.0um NICKEL OVER 5.0um Min.COPPER

2.3.1.5u" Min.Au+80~150U".NICKEL+100U"Min.COPPER

2.4.3.0um-5.0um NICKEL OVER 5.0um Min.COPPER(SPECIAL PLATED)

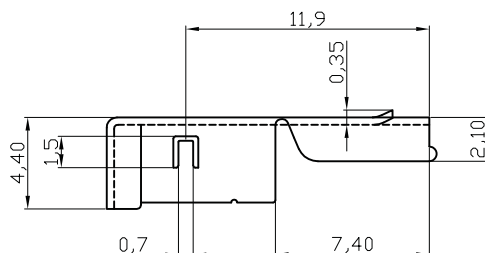
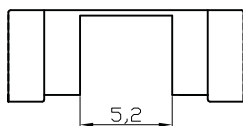

Unit: mm



Scale	Free					Date	Name	Title	
TOLERANCE						Drawn	10.04.12	Miller	ASSMANN WSW-No. A-USBPA-2-R
.XX	±0.10					Approved	12.02.13	Groll	
.X	±0.20								Drawing-No.
X.	±0.50								rev01
XX.	±1								
DIM	TOL								Sheet 4/4
		①	Tooling modification	12.02.13	Wilson	ASSMANN WSW components		Replace	
Angle	TOL	Id.	Modification	Date	Name			1840 W. Drake Drive, Suite 101 • Tempe, AZ 85283 Toll Free: 1-877-277-6266 • Email: info@assmann.us	

1

2

3

4

5

6

7