

HDSP-C5x1/C5x3

0.52" Single Digit PCB Based LED Display



Data Sheet

Description

This is 0.52" height single digit display. It utilizes GaAsP/ GaP Red, Orange, Yellow, Green and AlGaAs/GaAs Red chips. This device is halogenated.

All devices are categorized for luminous intensity. The orange, yellow and green devices are categorized for color. Use of similar device categories will yield a uniform display.

Features

- High reliability
- Excellent characters appearance
- Available in CA and CC
- RoHS Compliant
- Gray top surface with white diffused segments.

Ordering Information

Red	Green	Yellow	Orange	AlGaAs Red	Description
HDSP-C5E1	HDSP-C5G1	HDSP-C5Y1	HDSP-C5L1	HDSP-C5A1	Common Anode, Right Hand Decimal
HDSP-C5E3	HDSP-C5G3	HDSP-C5Y3	HDSP-C5L3	HDSP-C5A3	Common Cathode, Right Hand Decimal

Package Dimensions

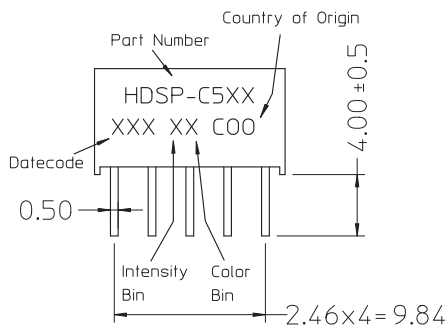
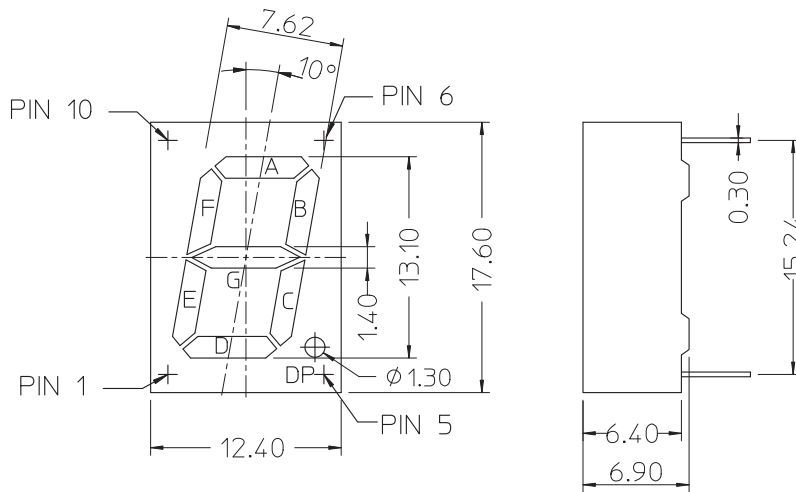

Notes:

1. All dimensions are in millimeter.
2. Unless otherwise stated, the tolerance is ± 0.25mm.

Circuit Diagram

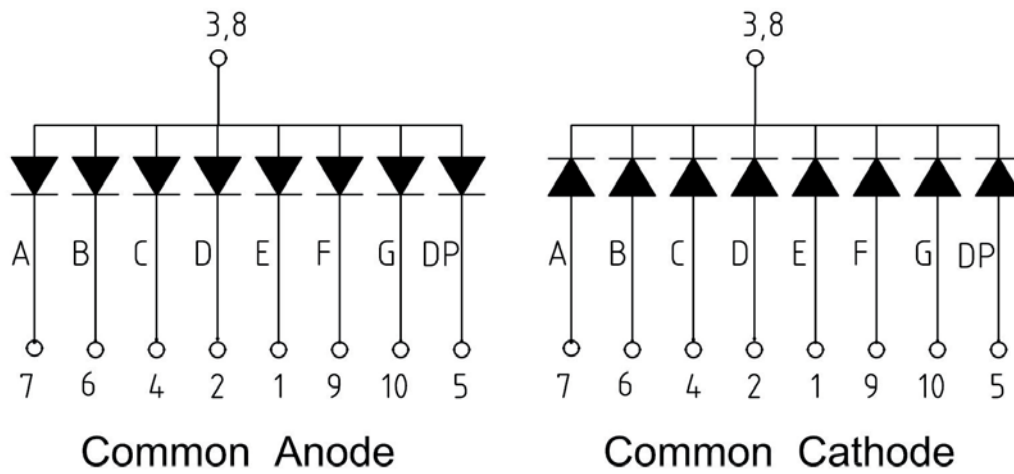

Absolute Maximum Ratings at $T_A = 25^\circ\text{C}$

Parameter	Symbol	Red/Yellow/ Orange	Green	AlGaAs Red	Units
Power Dissipation per segment or Dot Point (DP)	P_D	57.5	62.5	50	mW
Continuous Forward Current per segment	I_F	25	25	25	mA
Peak Forward Current per segment (1/10 Duty Cycle, 0.1m sec pulse width)		80	80	80	mA
Derating Linearly from 25°C per segment		0.33	0.33	0.33	mA/°C
Reverse Voltage per segment or DP	V_R		5		V
Operating Temperature	T_O		-40 to 85		°C
Storage Temperature	T_S		-40 to 85		°C
Wave solder Condition 1.6mm below body			250°C peak for 3 secs max		

Electrical / Optical Characteristic at $T_A = 25^\circ\text{C}$ **Red**

Parameter	Symbol	Min	Typ	Max	Units	Test Conditions
Average Luminous Intensity (Digit Average)	I_V	–	4.0	–	mcd	$I_F = 10\text{mA}$
Peak Wavelength	λ_p	–	640	–	nm	$I_F = 20\text{mA}$
Dominant Wavelength	λ_d	–	626	–	nm	$I_F = 20\text{mA}$
Forward Voltage per segment or DP	V_F	–	2.0	2.3	V	$I_F = 20\text{mA}$
Reverse Current	I_R	–	–	100	μA	$V_R = 5\text{V}$
Luminous Intensity Matching Ratio (Segment to Segment)	I_{V-M}		2:1			$I_F = 10\text{mA}$

Green

Parameter	Symbol	Min	Typ	Max	Units	Test Conditions
Average Luminous Intensity (Digit Average)	I_V	–	6.0	–	mcd	$I_F = 10\text{mA}$
Peak Wavelength	λ_p	–	565	–	nm	$I_F = 20\text{mA}$
Dominant Wavelength	λ_d	–	569	–	nm	$I_F = 20\text{mA}$
Forward Voltage per segment or DP	V_F	–	2.25	2.5	V	$I_F = 20\text{mA}$
Reverse Current	I_R	–	–	100	μA	$V_R = 5\text{V}$
Luminous Intensity Matching Ratio (Segment to Segment)	I_{V-M}		2:1			$I_F = 10\text{mA}$

Yellow

Parameter	Symbol	Min	Typ	Max	Units	Test Conditions
Average Luminous Intensity (Digit Average)	I_V	–	3.0	–	mcd	$I_F = 10\text{mA}$
Peak Wavelength	λ_p	–	587	–	nm	$I_F = 20\text{mA}$
Dominant Wavelength	λ_d	–	589	–	nm	$I_F = 20\text{mA}$
Forward Voltage per segment or DP	V_F	–	2.15	2.3	V	$I_F = 20\text{mA}$
Reverse Current	I_R	–	–	100	μA	$V_R = 5\text{V}$
Luminous Intensity Matching Ratio (Segment to Segment)	I_{V-M}		2:1			$I_F = 10\text{mA}$

Orange

Parameter	Symbol	Min	Typ	Max	Units	Test Conditions
Average Luminous Intensity (Digit Average)	I_V	–	4.0	–	mcd	$I_F = 10\text{mA}$
Peak Wavelength	λ_p	–	610	–	nm	$I_F = 20\text{mA}$
Dominant Wavelength	λ_d	–	605	–	nm	$I_F = 20\text{mA}$
Forward Voltage per segment or DP	V_F	–	2.15	2.3	V	$I_F = 20\text{mA}$
Reverse Current	I_R	–	–	100	μA	$V_R = 5\text{V}$
Luminous Intensity Matching Ratio (Segment to Segment)	I_{V-M}		2:1			$I_F = 10\text{mA}$

AlGaAs Red

Parameter	Symbol	Min	Typ	Max	Units	Test Conditions
Average Luminous Intensity (Digit Average)	I_V	–	16	–	mcd	$I_F = 10\text{mA}$
Peak Wavelength	λ_p	–	660	–	nm	$I_F = 20\text{mA}$
Dominant Wavelength	λ_d	–	643	–	nm	$I_F = 20\text{mA}$
Forward Voltage per segment or DP	V_F	–	1.85	2.0	V	$I_F = 20\text{mA}$
Reverse Current	I_R	–	–	100	μA	$V_R = 5\text{V}$
Luminous Intensity Matching Ratio (Segment to Segment)	I_{V-M}		2:1			$I_F = 10\text{mA}$

Red

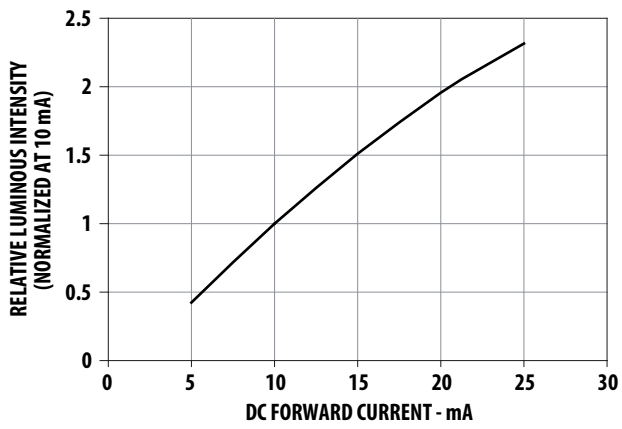

Figure 1. Relative Luminous Intensity Vs Forward Current

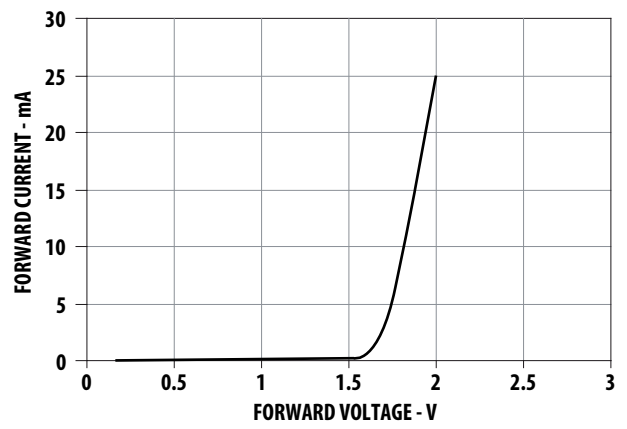

Figure 2. Forward Voltage Vs Current

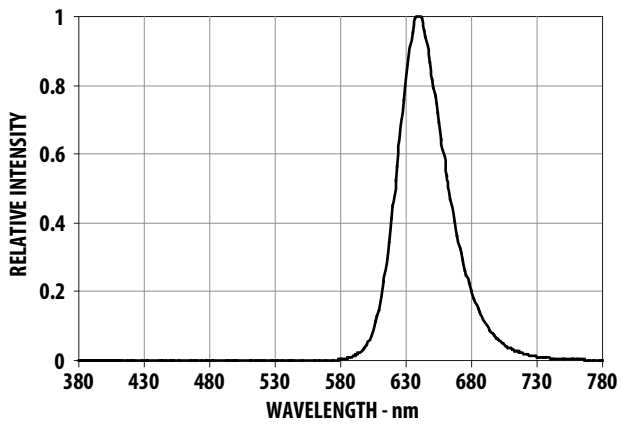

Figure 3. Relative Luminous Intensity Vs Wavelength

Green

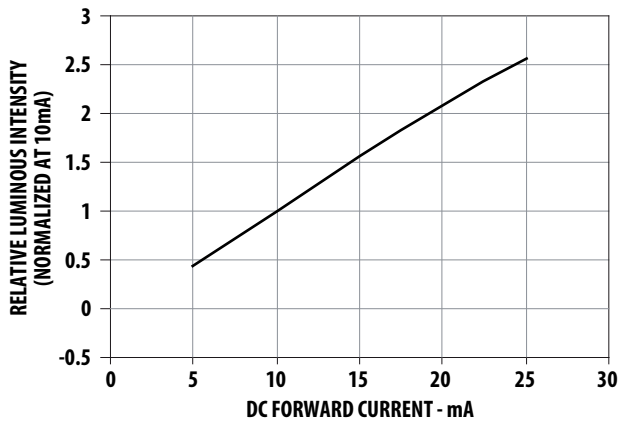

Figure 4. Relative Luminous Intensity Vs Forward Current

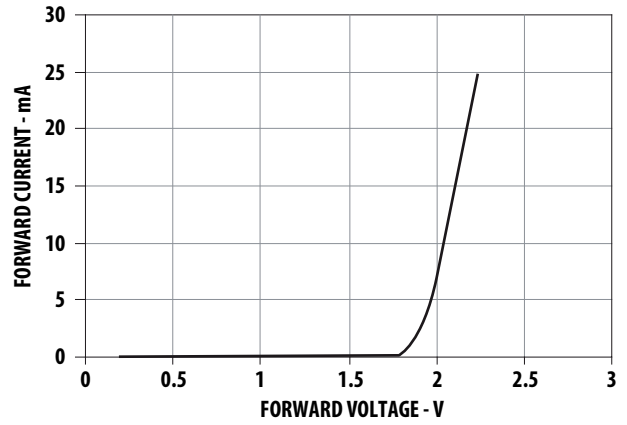

Figure 5. Forward Voltage Vs Current

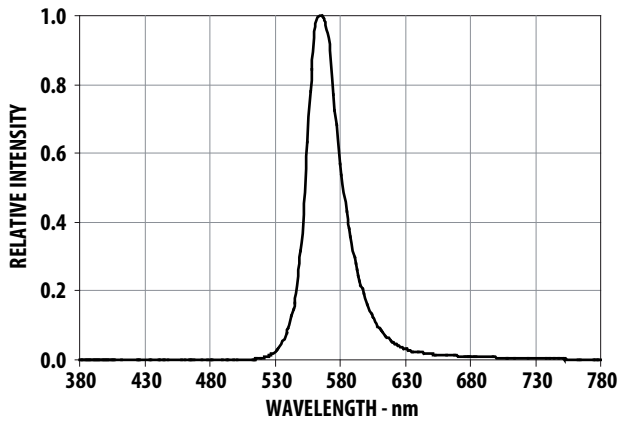

Figure 6. Relative Luminous Intensity Vs Wavelength

Yellow

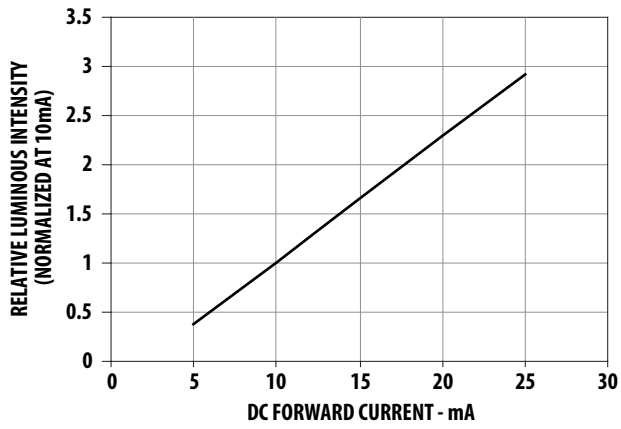

Figure 7. Relative Luminous Intensity Vs Forward Current

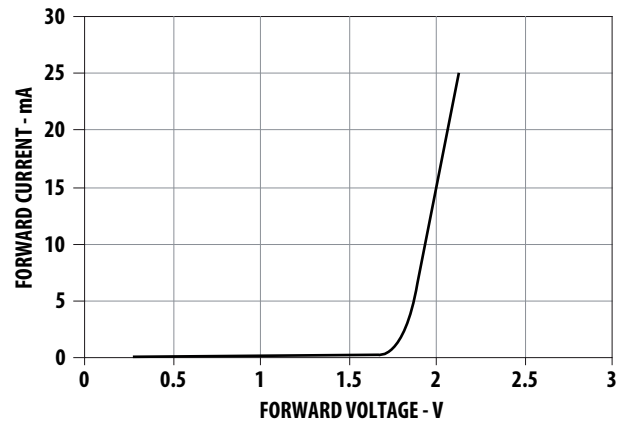

Figure 8. Forward Voltage Vs Current

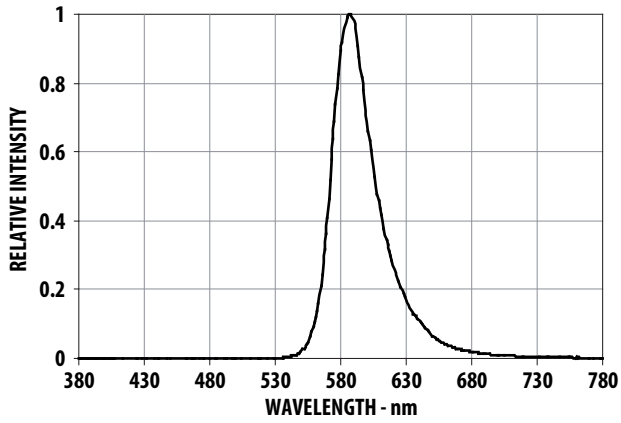

Figure 9. Relative Luminous Intensity Vs Wavelength

Orange

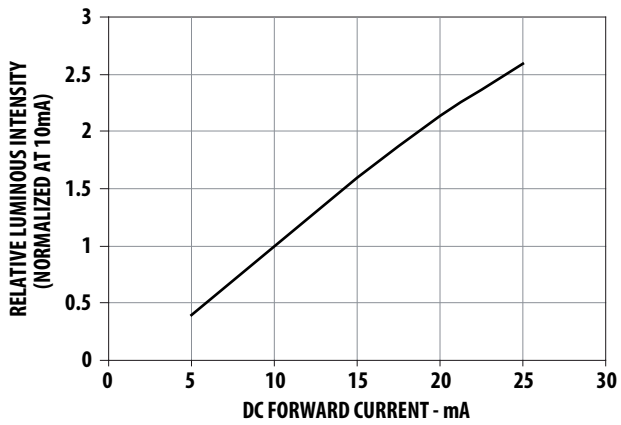

Figure 10. Relative Luminous Intensity Vs Forward Current

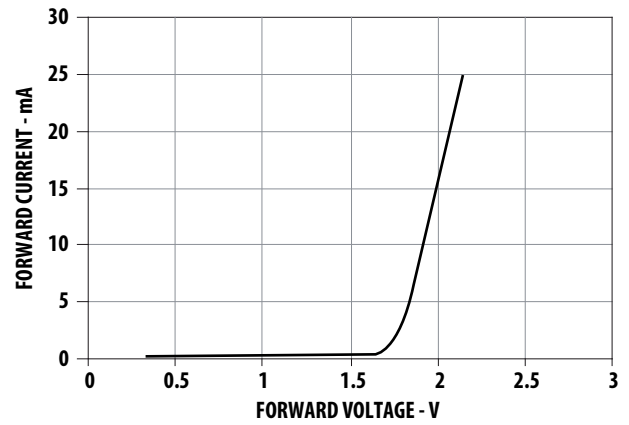

Figure 11. Forward Voltage Vs Current

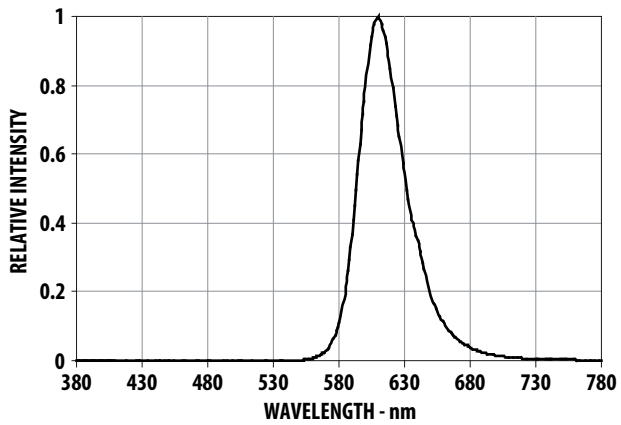

Figure 12. Relative Luminous Intensity Vs Wavelength

AlGaAs Red

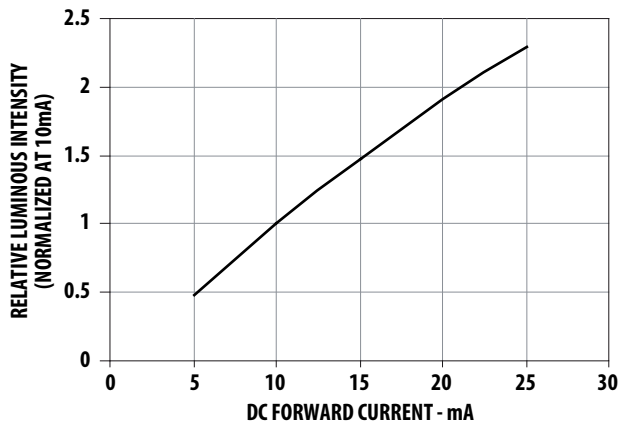

Figure 13. Relative Luminous Intensity Vs Forward Current

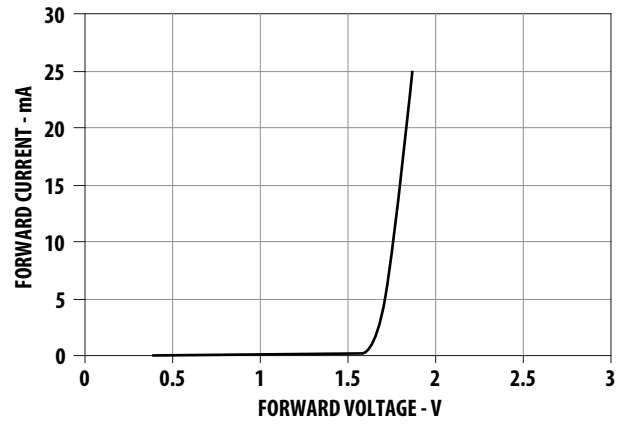

Figure 14. Forward Voltage Vs Current

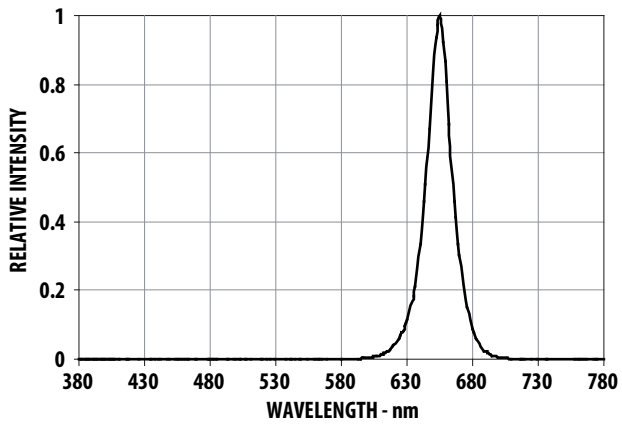
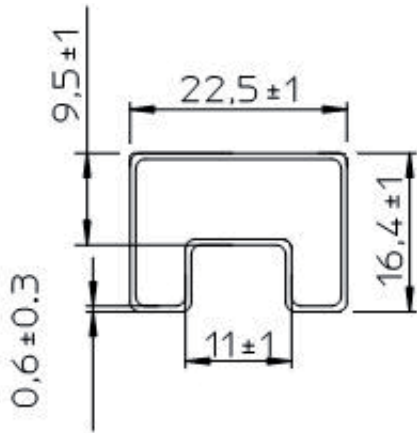
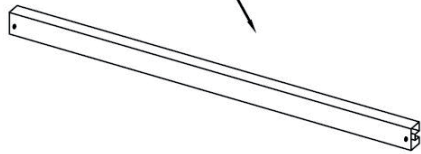

Figure 15. Relative Luminous Intensity Vs Wavelength

Packing Tube Specifications:

25 PCS PRODUCTS PER IC TUBE



Tube Front View



Tube Top View

For product information and a complete list of distributors, please go to our web site: www.avagotech.com

Avago, Avago Technologies, and the A logo are trademarks of Avago Technologies in the United States and other countries. Data subject to change. Copyright © 2005-2010 Avago Technologies. All rights reserved. AV02-2493EN - October 19, 2010

