

# SC Type Fiber Optic Connectors

## HSC Series

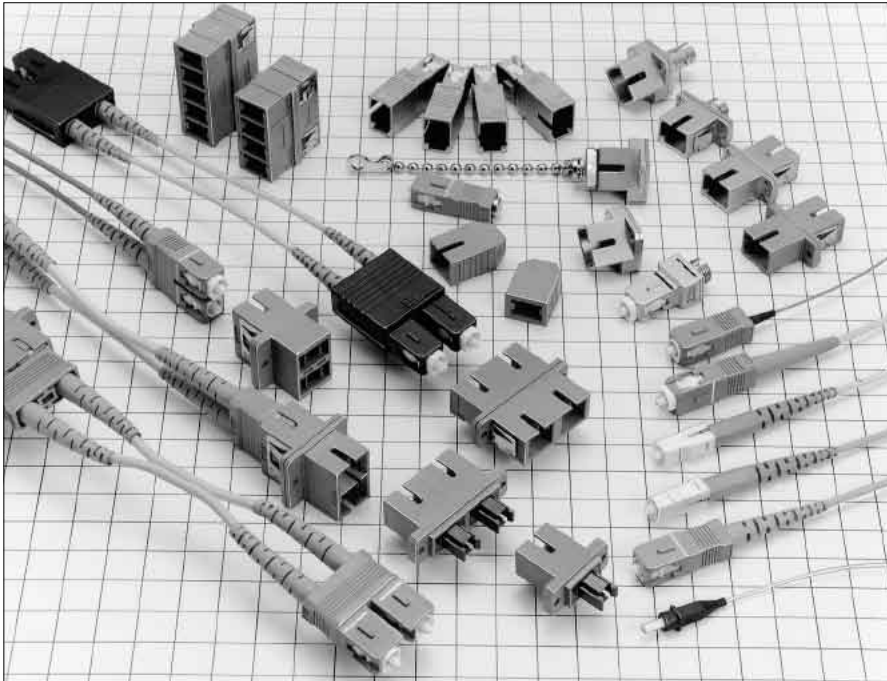

### ■ Features

#### 1. IEC, JIS standard compliant and intermateability test certified.

Comply with IEC 61754-4 and JIS C 5973(F04).  
SC intermate test by NTT certified connector.

#### 2. Flame resistant

Satisfies flammability rating UL94V-0.

#### 3. Three types of Duplex SC connector

Available in following types;

Flexible F type – Floating mechanism and comply with ANSI standards.

Rigid F type – 12.7mm spacing between the fibers, low profile and compatibility with the flexible F-type.

Rigid H type – 8.5mm spacing between the fibers and for high density applications.

#### 4. Simplified plugs and receptacles

Small size (23.8 mm plug length). SC simplified plug is designed for equipments inside connection. Comply with IEC 61754-4-1.

## Product Specifications

Ratings		Operating temperature range		-25°C to +70°C	Storage temperature range		-25°C to +70°C
Item		Test Method (IEC 61300)			Specifications		
Optical Characteristics	Insertion Loss	(SM)	Wavelength 1310nm (LD)		0.5dB max. (PC, AdPC, APC)		
		(GI)	Wavelength 1310nm (LED)		0.3dB max. (PC)		
	Return Loss	(SM)	Wavelength 1310nm (LD)		22dB min. (PC) 40dB min. (AdPC)		
		(GI)			22dB min. (PC)		
Mechanical Characteristics	Engagement and Separation force		Measured with corresponding connector.			Simplex plug Engagement force: 19.6 N max. Separation force: 19.6 N max. Duplex plug Engagement force: 39 N max. Separation force: 39 N max.	
	Ferrule withdrawal force		Extract zirconia gauge 2.499 ±0.0005 mm dia from split sleeve.			Copper alloy split sleeve 2N to 5.9N Zirconia split sleeve 2N to 3.9N	
	Cable retention (Straight pull)		89N tensile load for one minute.			1) Insertion loss fluctuation after test: 0.2dB max. 2) No visible damage, dislocation of clamp or cable.	
	Durability (cycles, mating/un-mating)		1000 times			1) Insertion loss fluctuation after test: 0.2dB max. 2) No visible damage, cracks or part dislocation.	
	Vibration		Frequency: 10 to 55 Hz, single amplitude of 0.75 mm, 2 hours in each of the 3 axis.				
	Shock		Acceleration of 981 m/s <sup>2</sup> , 6 ms duration, half sine shock pulse, 10 cycles in each of the 3 axis.				
Humidity (Temperature/ humidity- cycles)		-10°C to +65°C, humidity: 90% to 96% 10 cycles					
Environmental Characteristics	Change of temperature		-40°C to +75°C 42 cycles (Complies with Telcordia standard GR-326-CORE)			No significant corrosion.	
	Dry heat		240 hours at 85°C				
	Cold		240 hours at -25°C				
	Salt mist		48 hours in a 5% concentration of salt mist				

## Materials

Part	Material
Simplex plug housing	Synthetic resin
Spring	Stainless steel
Ferrule	Zirconia
Simplex adapter housing	Synthetic resin or Zinc alloy
4-position adapter housing	Synthetic resin
5-position adapter housing	Synthetic resin
Receptacle housing	Zinc alloy
Split sleeve	Zirconia or Phosphor Bronze
Dust cap	Synthetic resin

## ■ Function diagram

### Plugs

#### Ferrules

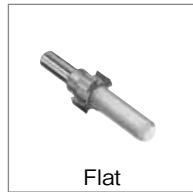

#### Plug housings

#### Manual coupling/ decoupling type

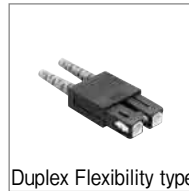
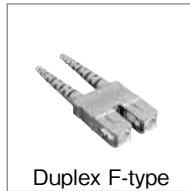

#### Tool decoupling type



### Adapters

#### Manual coupling/ decoupling type

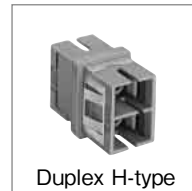
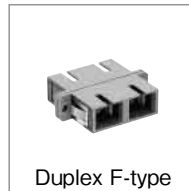
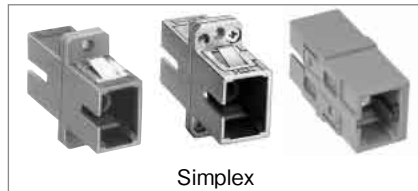

#### Tool decoupling type



#### Conversion adapters

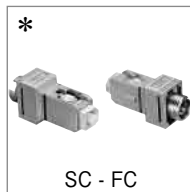

Note \*Please refer to the section HRFC.

#### Receptacle



SC

FC

MU

Harsh  
Environment

Attenuators

Terminators

POF / PCF

Simplified plugs & receptacles

Plugs



Receptacles

Manual coupling/  
decoupling type

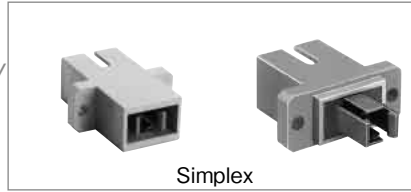

Simplex

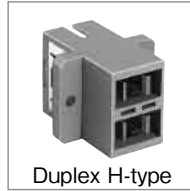

Duplex H-type

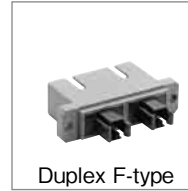

Duplex F-type

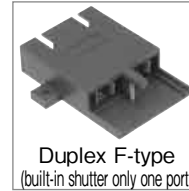

Duplex F-type  
(built-in shutter only one part)

Tool decoupling  
type

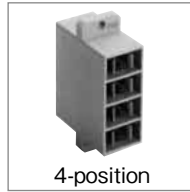

4-position

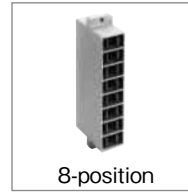

8-position

Split sleeve

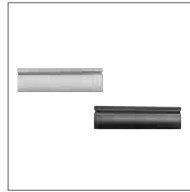

Caps

For plug



For adapter



SC

FC

MU

Harsh  
Environment

Attenuators

Terminators

POF / PCF

# 1. Ferrules

- ① It is not possible to connect it with a ferrule alone. Please use it with the plug housing.
- ② The angle of the fiber entrance (cone) is 60 degrees or 90 degrees.

## ●For PC, AdPC and UPC(Flat)

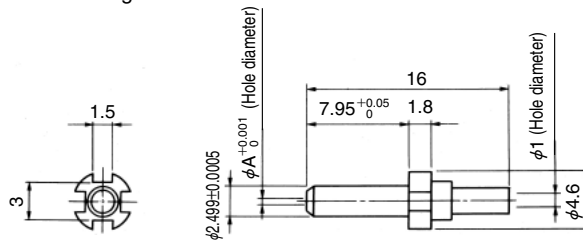

Part Number	CL No.	A dimension	Applicable Fiber cable
HSC-F321-A125(10)	704-0070-9-10	0.125	SM-9.5/125 GI-50/125
HSC-F321-A1255(10)	704-0200-2-10	0.1255	
HSC-F321-A126(10)	704-0071-1-10	0.126	

## ●For PC, AdPC and UPC(Pre-dome)

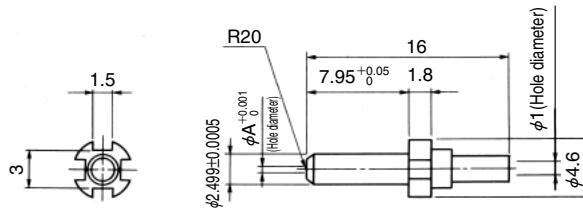

Part Number	CL No.	A dimension	Applicable Fiber cable
HSC-F3E2-A125	704-0590-9-00	0.125	SM-9.5/125 GI-50/125
HSC-F3E2-A1255	704-0571-4-00	0.1255	
HSC-F3E2-A126	704-0591-1-00	0.126	

## ●For APC

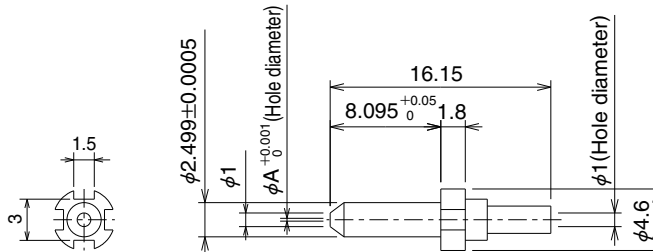

Part Number	CL No.	A dimension	Applicable Fiber cable
HSC-F391-A125(40)	704-3101-7-40	0.125	SM-9.5/125
HSC-F391-A1255(40)	704-3130-5-40	0.1255	
HSC-F391-A126(40)	704-3102-0-40	0.126	

SC

FC

MU

Harsh Environment

Attenuators

Terminators

POF / PCF

## 2. Plug Housings

Please use them with the ferrule.

### ■ Manual coupling / decoupling type

#### ● Light weight type (For 0.9mm fiber)

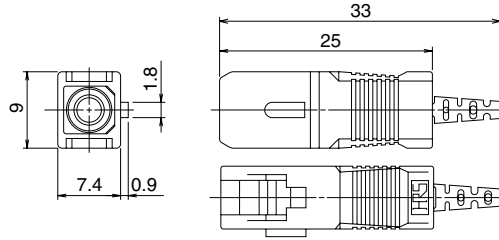

Part Number	CL No.	Boot color	Slider color	Polishing type
HSC-PH0.9-E1(26)	704-0339-2-26	Blue	Blue	PC
HSC-PH0.9-E2(51)	704-0354-6-51	Light purple		AdPC
HSC-PH0.9-E5(51)	704-3104-5-51	Green	Green	APC

#### ● Strain relief type

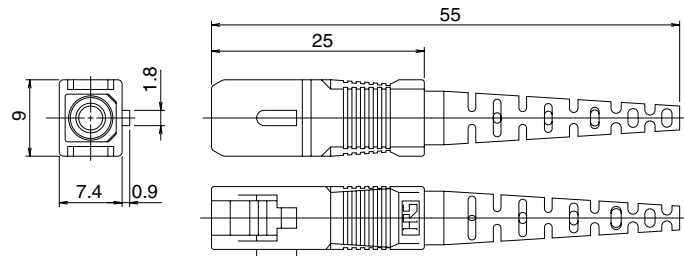

Part Number	CL No.	Fiber cable type	Slider color	Boot color	Polishing type	Outer jacket fixing
HSC-PH2-E1(64)	704-0327-3-64	φ2mm	Blue	Blue	PC	Crimp
HSC-PH2-E2(75)	704-0328-6-75			Light purple	AdPC	
HSC-PH2-E6(73)	704-0344-2-73			White	—	
HSC-PH2-E5(68)	704-3108-6-68		Green	Green	APC	
HSC-PH3-B1(68)	704-0222-5-68	φ3mm	Blue	Blue	PC	Crimp
HSC-PH3-B2(68)	704-0223-8-68			Light purple	AdPC	
HSC-PH3-B6(62)	704-0282-7-62			White	—	
HSC-PH3-B5(62)	704-3020-7-62		Green	Green	APC	

#### ● Short length type (For 2mm Cable)

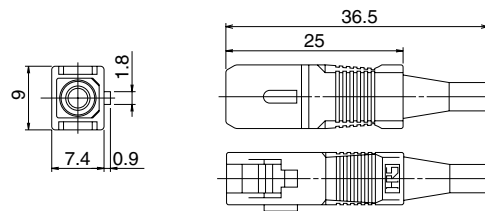

Part Number	CL No.	Slider color	Boot color	Polishing type	Outer jacket fixing
HSC-PH2-E1-A(62)	704-0464-4-62	Blue	Blue	PC	Glue
HSC-PH2-E2-A(62)	704-0480-0-62		Light purple	AdPC	
HSC-PH2-E5-A(60)	704-3124-2-60	Green	Green	APC	

● Duplex F-type

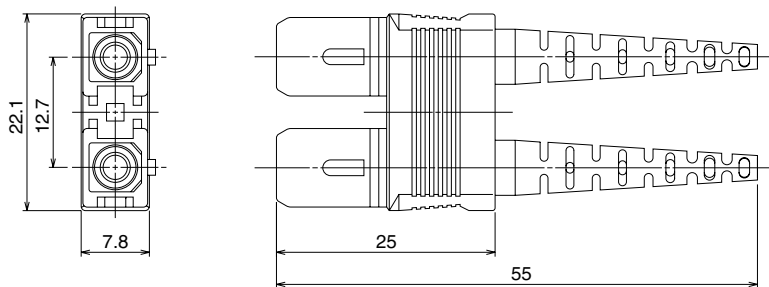

Part Number	CL No.	Applicable Fiber cable	Guide key	Slider color	Boot Color	Polishing type
HSCF-2PH2-E1(P)(62)	704-2109-3-62	φ2mm	P	Blue	Blue	PC
HSCF-2PH2-E2(P)(62)	704-2120-6-62				Light purple	AdPC
HSCF-2PH3-B1(P)(63)	704-2032-0-63	φ3mm			Blue	PC
HSCF-2PH3-B2(P)(65)	704-2036-1-65				Light purple	AdPC

● Duplex Flexibility type (Comply with ANSI), for single Mode

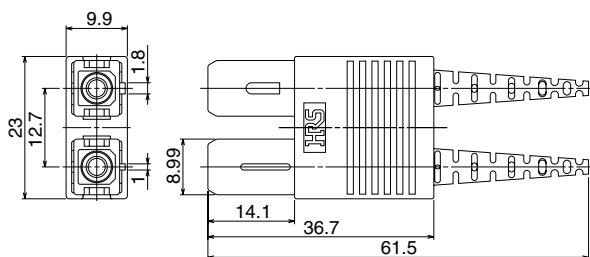

Part Number	CL No.	Applicable Fiber cable	Slider color	Boot Color	Polishing type
HSCM-2SPH2-B1(60)	704-2100-9-60	Simplex-2mm dia. cable or dual fiber zip cable	Black	Blue	PC
HSCM-2SPH3-B1(60)	704-2102-4-60	Simplex-3mm dia. cable or dual fiber zip cable		Light purple	AdPC
HSCM-2SPH2-B2(60)	704-2133-8-60	Simplex-2mm dia. cable or dual fiber zip cable			

The pitch size between plugs is flexible.  
It is possible to connect it with duplex F-type adapter.

● Duplex Flexibility type (Comply with ANSI), for Multi-mode

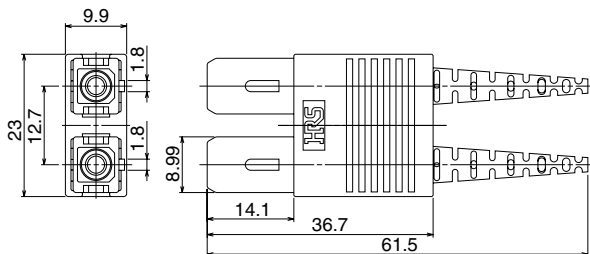

Part Number	CL No.	Applicable Fiber cable	Slider color	Boot Color	Polishing type
HSCM-2GPH2-B1(60)	704-2104-0-60	Simplex-2mm dia. cable or dual fiber zip cable	Black	Blue	PC
HSCM-2GPH3-B1(60)	704-2106-5-60	Simplex-3mm dia. cable or dual fiber zip cable			

The pitch size between plugs is flexible.  
It is possible to connect it with duplex F-type adapter.

## ■ Tool decoupling type

### ● Light weight type (For 0.9mm fiber)

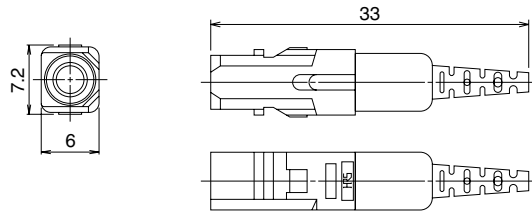

Part Number	CL No.	Boot Color	Polishing type
HSC2-PH0.9-E1(51)	704-0421-1-51	Blue	PC
HSC2-PH0.9-E2(51)	704-0422-4-51	Light purple	AdPC

### ● Strain relief type

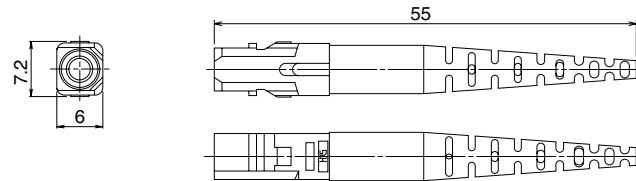

Part Number	CL No.	Fiber cable type	Boot color	Polishing type	Outer jacket fixing
HSC2-PH2-E1(69)	704-0329-9-69	φ2mm	Blue	PC	Glue
HSC2-PH2-E2(68)	704-0330-8-68		Light purple	AdPC	
HSC2-PH3-B1(63)	704-0226-6-63	φ3mm	Blue	PC	Crimp
HSC2-PH3-B2(63)	704-0227-9-63		Light purple	AdPC	



### 3.Adapters & Receptacles

#### Manual coupling / decoupling type

##### SC/SC Plastic Housing

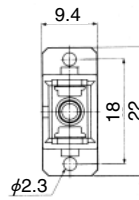
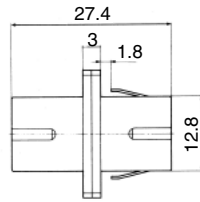

##### Panel cutout

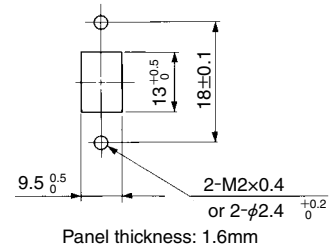

Part Number	CL No.	Split sleeve	Remarks
HSC-A3(51)	704-0092-1-51	Phosphor Bronze	PC,AdPC(Blue)
HSC-A3-D1(02)	704-0217-5-02	Zirconia	
HSC-A3-D2(06)	704-3007-9-06	Zirconia	APC(Green)

##### SC/SC Die Cast Metal Housing

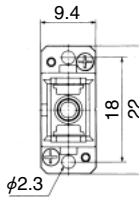
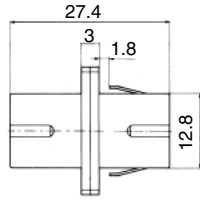

##### Panel cutout

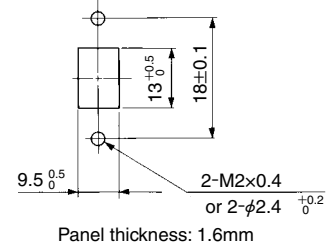

Part Number	CL No.	Split sleeve
HSC-A2(50)	704-0020-0-50	Phosphor Bronze
HSC-A2-D1(01)	704-0258-2-01	Zirconia

##### SC/SC Plastic Housing (Short flange)

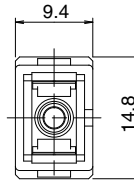
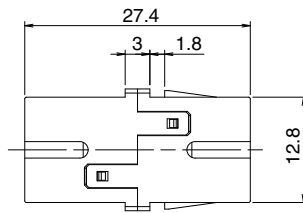

##### Panel cutout

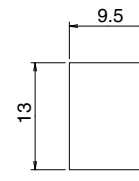

Part Number	CL No.	Split sleeve	Snap in latch for panel mount	Remarks
HSC-AFR-D1(01)	704-0572-7-01	Zirconia	without latch	PC,AdPC(Blue)
HSC-AFR-D2(01)	704-0573-0-01	Zirconia	with latch	

Note: When applying excessive force to the plug or inserting in an odd angle, the adapter housing might be damaged.

● SC/SC Plastic Housing (With shutter)

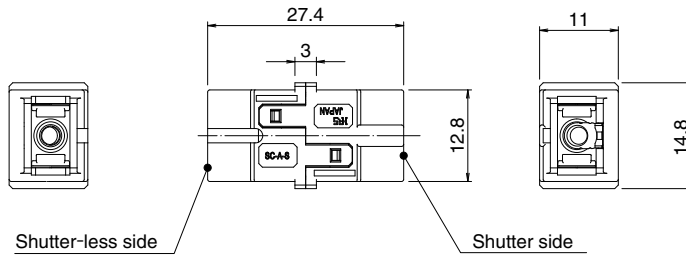

Part Number	CL No.	Split sleeve	Remarks
HSC-AFL1-S1-D1	704-0593-7-00	Zirconia	PC, AdPC(Blue)
HSC-AFL1-S1-D2	704-3141-1-00	Zirconia	APC(Green)

**Features**

With built-in automatic shutter.

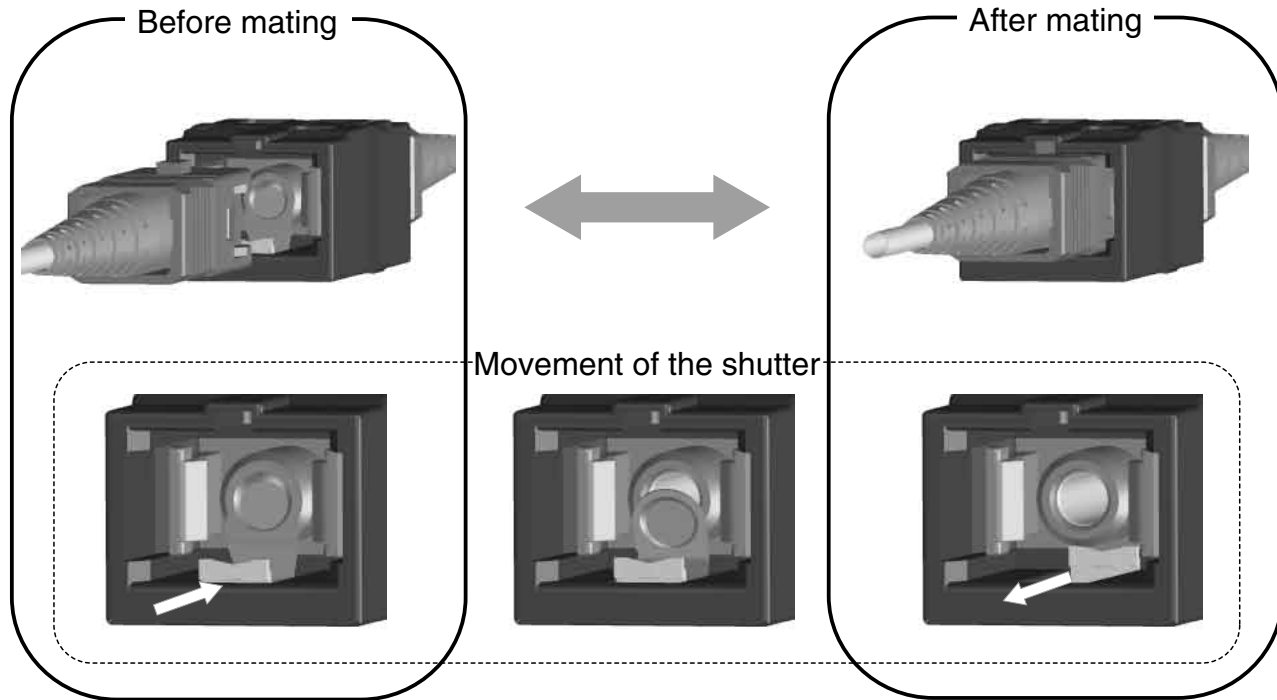

SC

FC

MU

Harsh Environment

Attenuators

Terminators

POF / PCF

SC

●F type Snap-in and/or Screw Mounting

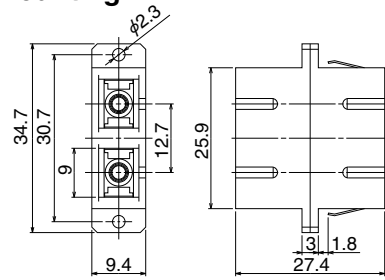
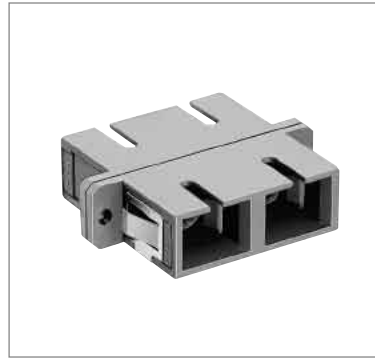

◆Panel cutout

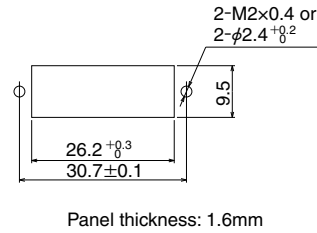

Part Number	CL No.	Split sleeve	Remarks
HSCF-2A(P)(51)	704-2008-6-51	Phosphor Bronze	PC, AdPC(Blue)
HSCF-2A-D(P)(06)	704-2040-9-06	Zirconia	
HSCF-2A-D2(P)(06)	704-2112-8-06		APC(Green)

●H type Snap-in

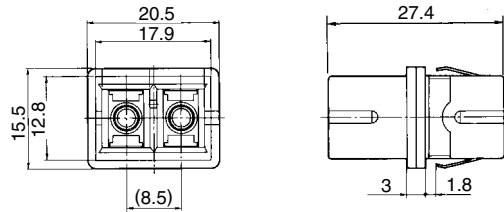

◆Panel cutout

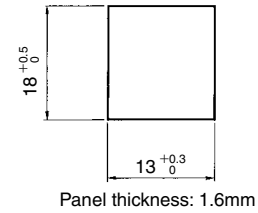

Part Number	CL No.	Split sleeve	Remarks
HSCH-2A1(P)(51)	704-2066-2-51	Phosphor Bronze	PC, AdPC(Blue)
HSCH-2A1-D2(P)	704-2137-9-00	Zirconia	APC(Green)

●H type Snap-in and/or Screw Mounting

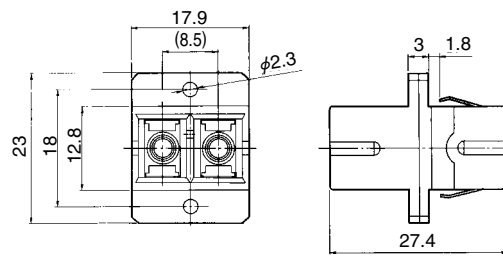

◆Panel cutout

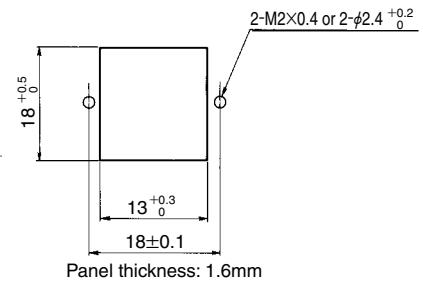

Part Number	CL No.	Split sleeve	Remarks
HSCH-2A(P)(51)	704-2020-1-51	Phosphor Bronze	PC, AdPC(Blue)
HSCH-2A-D(P)(02)	704-2062-1-02	Zirconia	
HSCH-2A-D2(P)(03)	704-2108-0-03		APC(Green)

FC

MU

Harsh Environment

Attenuators

Terminators

POF / PCF

■ Tool decoupling type

● SC2/SC2 4-way adapter

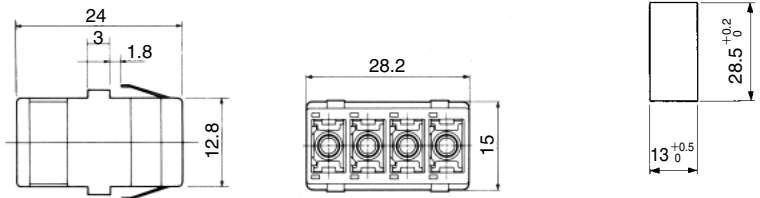

Panel thickness: 1.6mm

Part Number	CL No.	Split sleeve	Remarks
HSC2-4A(51)	704-0024-1-51	Phosphor Bronze	PC,AdPC(Blue)
HSC2-4A-D1(01)	704-0290-5-01	Zirconia	

Note: When applying excessive force to the plug or inserting in an odd angle, the zirconia sleeve within the adapter might be damaged.

● SC2/SC2 5-way adapter(for Multi-mode fiber)

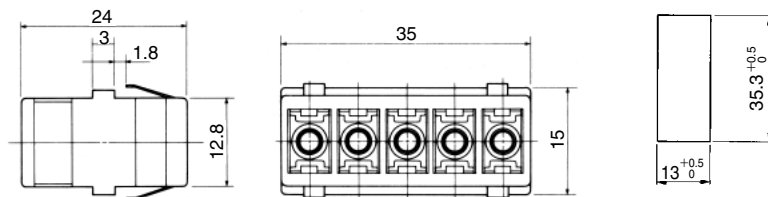

Panel thickness: 1.6mm

Part Number	CL No.	Split sleeve	Remarks
HSC2-5A(51)	704-0025-4-51	Phosphor Bronze	PC,AdPC(Blue)

Note: When applying excessive force to the plug or inserting in an odd angle, the zirconia sleeve within the adapter might be damaged.

■ Conversion adapters

● FC / SC Screw Mounting

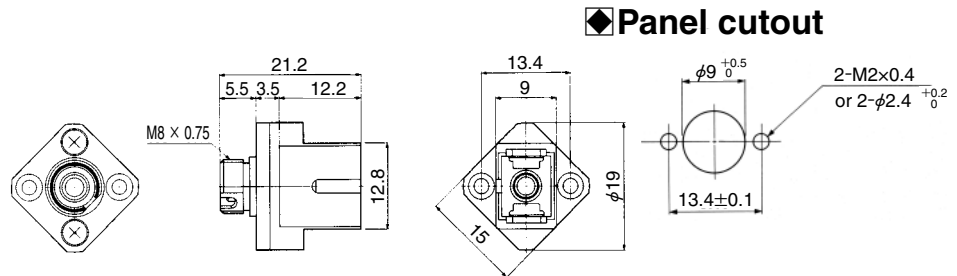

Part Number	CL No.	Split sleeve
HSCJ-HRFCJ-B(43)	704-0021-3-43	Phosphor Bronze

Note: The type of SC plug that can be mated is manual coupling/decoupling type.

● FC / SC Snap-in and/or Screw Mounting

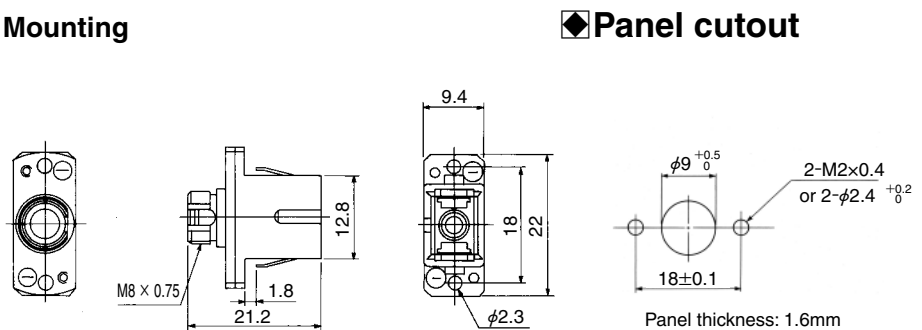

Part Number	CL No.	Split sleeve
HSCJ-HRFCJ-C(43)	704-0206-9-43	Phosphor Bronze

Note: The type of SC plug that can be mated is manual coupling/decoupling type.

## ■ Receptacles

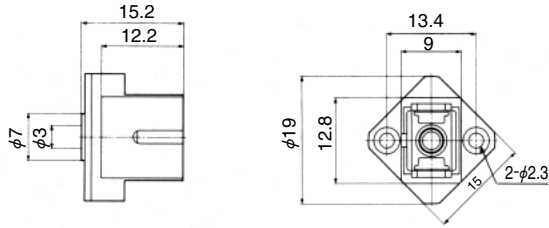

Note: Designed for power meter sensors

Part Number	CL No.	Remarks
HSC-R1-B(41)	704-0022-6-41	For MM
HSC-R2-B(41)	704-0023-9-41	For SM

Note: The type of SC plug that can be mated is manual coupling/decoupling type.

## 4. Simplified plugs & receptacles

### ■ Features

1. This product greatly reduced the number of parts compared with the SC connector, and achieved cost-saving.

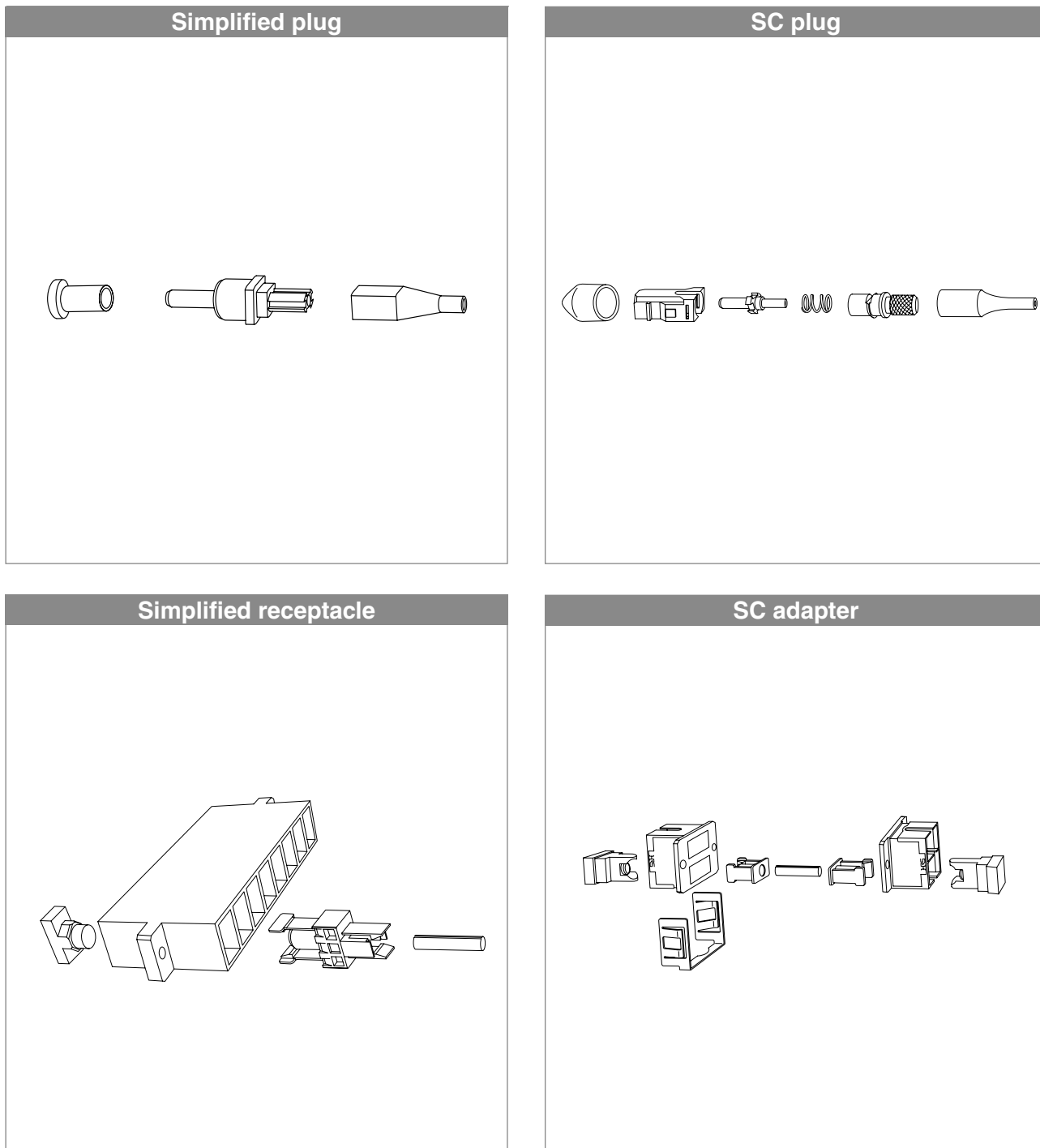

2. It achieved space-saving by using this product inside of the system.

3. Please use a special tool when you decouple the plug.

## ■ Simplified plug

Please use the special decoupling tool when you unmate the simplified plug.

### ● Simplified plug(Flat)

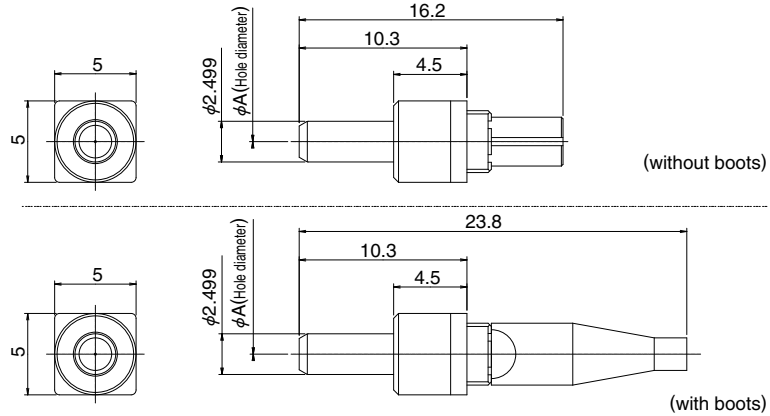

Part Number	CL No.	A dimension	Remarks
HSC2-FK-A125(56)	704-0267-3-56	0.125	without boots
HSC2-FK-A1255(56)	704-0269-9-56	0.1255	
HSC2-FK-A126(56)	704-0268-6-56	0.126	
HSC2-FK-A125(51)	704-0267-3-51	0.125	with boots
HSC2-FK-A1255(51)	704-0269-9-51	0.1255	
HSC2-FK-A126(51)	704-0268-6-51	0.126	

### ● Simplified plug(Pre-dome)

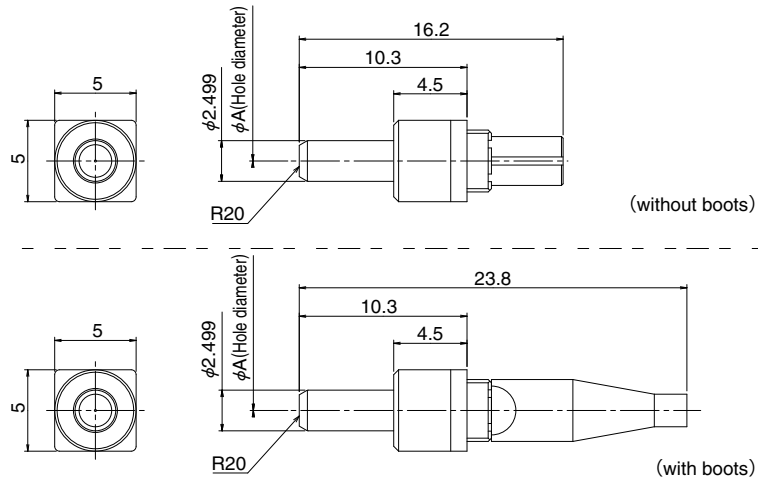

Part Number	CL No.	A dimension	Remarks
HSC2-FK2-A125(56)	704-0407-0-56	0.125	without boots
HSC2-FK2-A1255(56)	704-0408-3-56	0.1255	
HSC2-FK2-A126(56)	704-0409-6-56	0.126	
HSC2-FK2-A125(51)	704-0407-0-51	0.125	with boots
HSC2-FK2-A1255(51)	704-0408-3-51	0.1255	
HSC2-FK2-A126(51)	704-0409-6-51	0.126	

### ■ Simplified receptacle to SC

#### ● Simplex / Shrouded

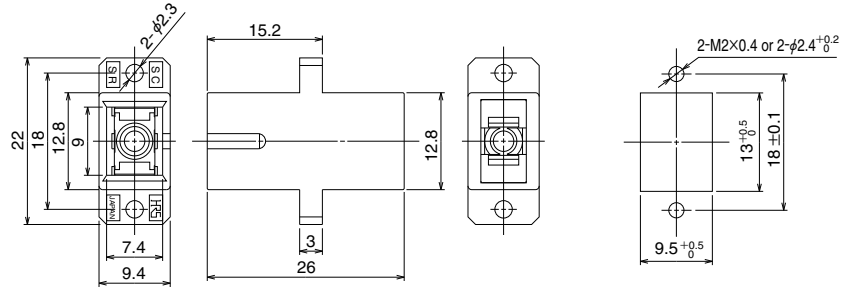

Part Number	CL No.	Split sleeve
HSC-SR-1(51)	704-0320-4-51	Phosphor Bronze
HSC-SR-D1(02)	704-0321-7-02	Zirconia
HSC-SR-1(03)	704-0320-4-03	None

Note. The type of SC plug that can be mated is manual coupling/decoupling type.

#### ◆ Panel cutout

#### ● Simplex / Unshrouded

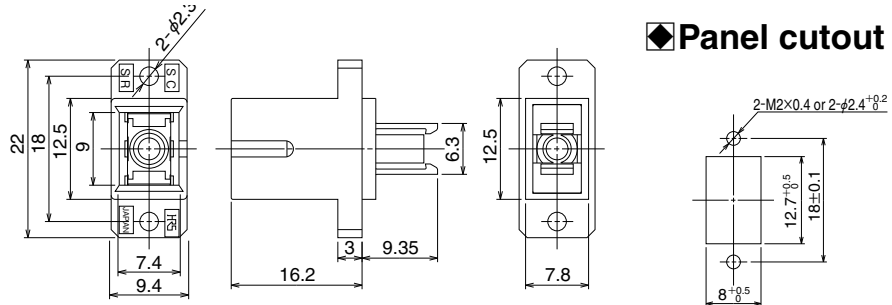
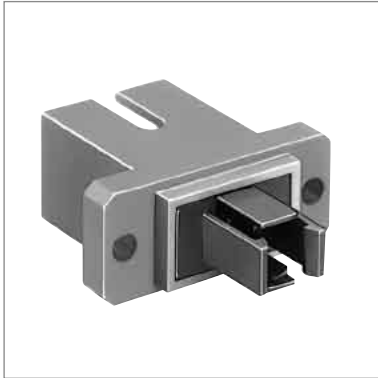

Part Number	CL No.	Split sleeve
HSC-SR-2(51)	704-0291-8-51	Phosphor Bronze
HSC-SR-D2(06)	704-0292-0-06	Zirconia
HSC-SR-2(03)	704-0291-8-03	None

Note. The type of SC plug that can be mated is manual coupling/decoupling type.

#### ◆ Panel cutout

#### ● Duplex H type / Shrouded

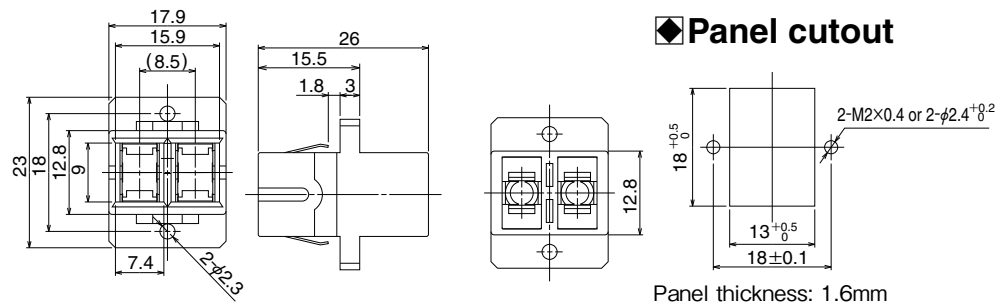

Part Number	CL No.	Split sleeve
HSCH-2SR-1(R)(51)	704-0293-3-51	Phosphor Bronze
HSCH-2SR-D1(R)(01)	704-0294-6-01	Zirconia

Note. The type of SC plug that can be mated is manual coupling/decoupling type.

#### ◆ Panel cutout



SC

● Duplex F type / Unshrouded

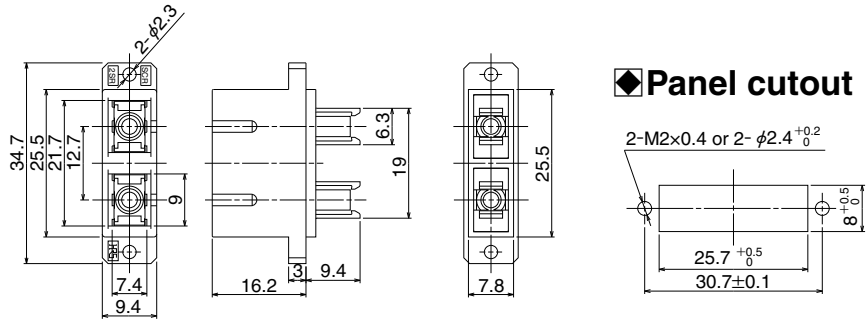
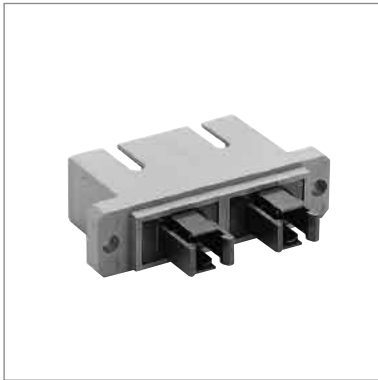

Part Number	CL No.	Split sleeve
HSCF-2SR-2(P)(51)	704-0295-9-51	Phosphor Bronze
HSCF-2SR-2(P)(03)	704-0295-9-03	None

Note. The type of SC plug that can be mated is manual coupling/decoupling type.

FC

MU

● Duplex F type / Shrouded, built-in shutter type

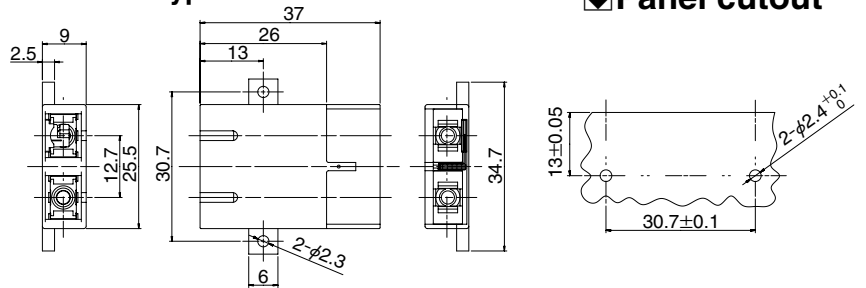

Part Number	CL No.	Split sleeve
HSCF-2SR-S2	704-0516-6-00	None

※ The type of SC plug that can be mated is manual coupling/decoupling type.  
Note. The shutter is built into only one of ports.

Harsh Environment

Attenuators

● 4-Position / Shrouded

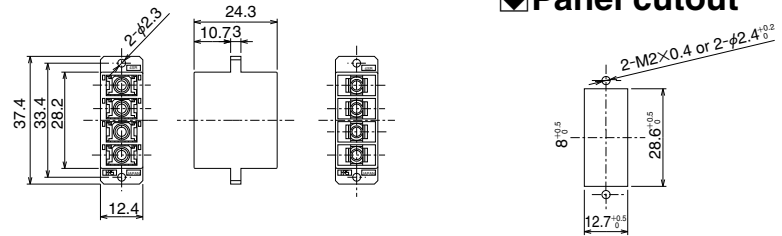

Part Number	CL No.	Split sleeve
HSC2-4SR-1(51)	704-0311-3-51	Phosphor Bronze
HSC2-4SR-D1(01)	704-0312-6-01	Zirconia
HSC2-4SR-1(03)	704-0311-3-03	None

Note: When applying excessive force to the plug or inserting in an odd angle, the zirconia sleeve within the adapter might be damaged.  
※ The type of SC plug that can be mated is tool decoupling type.

Terminators

POF / PCF

●8-Position / Shrouded

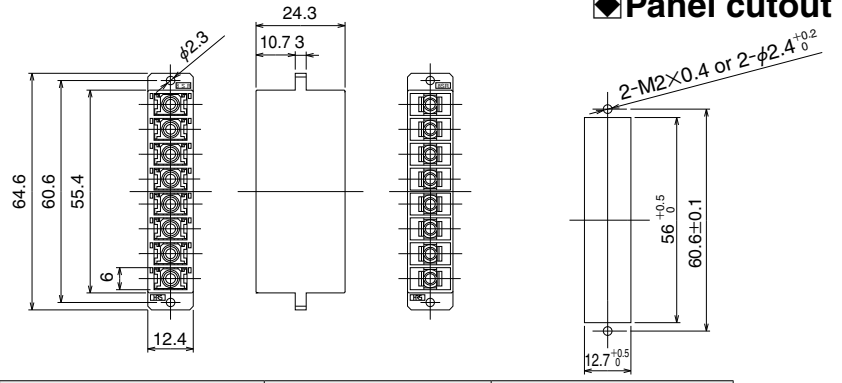

Part Number	CL No.	Split sleeve
HSC2-8SR-D1(01)	704-0270-8-01	Zirconia
HSC2-8SR-1(03)	704-0266-0-03	None

Note: When applying excessive force to the plug or inserting in an odd angle, the zirconia sleeve within the adapter might be damaged.  
 ※ The type of SC plug that can be mated is tool decoupling type.

●8-Position / Unshrouded

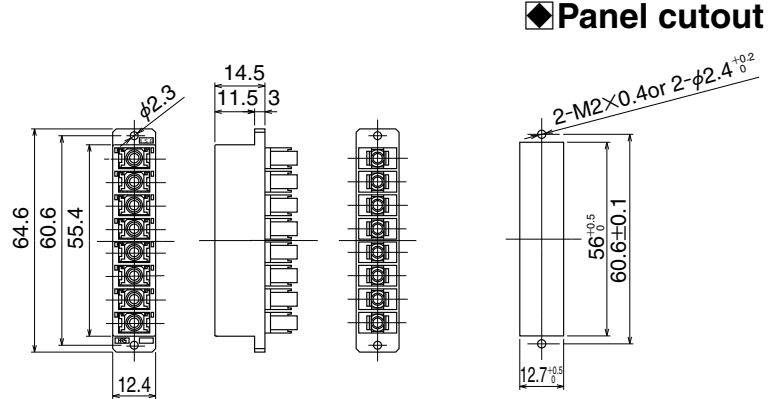

Part Number	CL No.	Split sleeve
HSC2-8SR-2(51)	704-0318-2-51	Phosphor Bronze
HSC2-8SR-D2(01)	704-0403-0-01	Zirconia
HSC2-8SR-2(03)	704-0318-2-03	None

Note: When applying excessive force to the plug or inserting in an odd angle, the zirconia sleeve within the adapter might be damaged.  
 ※ The type of SC plug that can be mated is tool decoupling type.

■Split sleeve

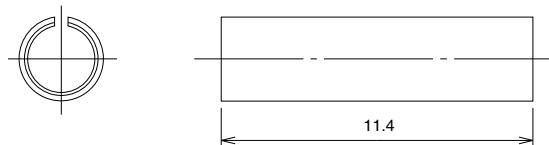
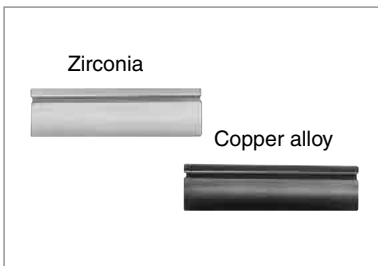

Part Number	CL No.	Split sleeve
HSC-SLIT-SLEEVE(51)	704-0275-1-51	Phosphor Bronze
HSC-D	704-0264-5-00	Zirconia

SC  
FC  
MU  
Harsh Environment  
Attenuators  
Terminators  
POF / PCF

## 5. Caps

### ■ For plug

#### ● Ferrule cap

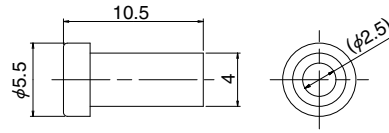

Part Number	CL No.
HSC-C7(20)	704-0420-9-20

- ※ HRS standard cap for plugs.
- ※ Press fit to ferrule outer.

#### ● Press fit to plug frame inner type cap

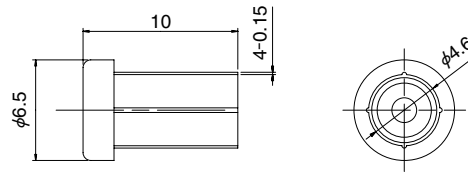

Part Number	CL No.
HSC-C1	704-0484-1-00

- ※ Press fit to plug frame inner. The cap will not touch the outside ferrule.

#### ● Cap for SC plug housing

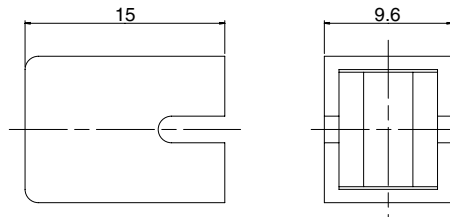

Part Number	CL No.
HSC-C8	704-0542-6-00

- ※ Press fit to outside of SC slider.

### ■ For adapter

#### ● Simplex plastic cap



Part Number	CL No.
HSC-C5	704-0363-7-00

- ※ HRS standard cap for SC adapters.
- ※ The cap is inserted in the lock part of the adapter.

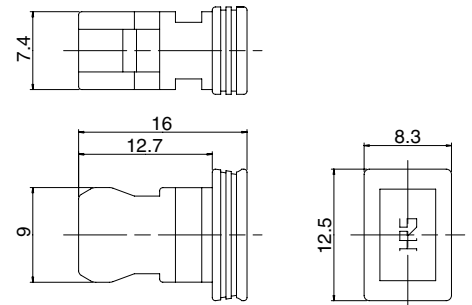

Part Number	CL No.
HSC-C9	704-0588-7-00

- ※ Press fit to adapter inner.

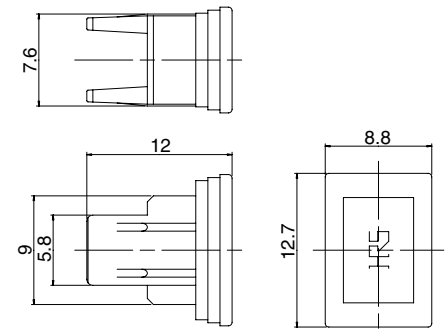

● Simplex rubber cap

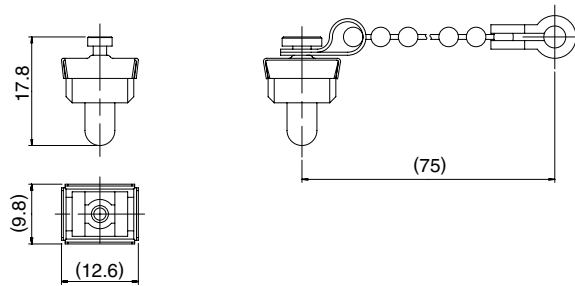

Part Number	CL No.	Remarks
HSC-C3(40)	704-0101-0-40	without cahin
HSC-C2(40)	704-0061-8-40	with cahin

※ Press fit to adapter inner.

● Simplex plastic cap

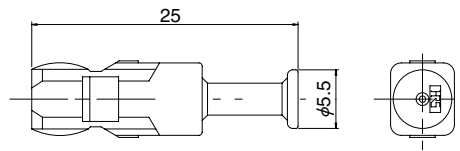

Part Number	CL No.
HSC2-C2	704-0487-0-00

※ The cap is inserted in the lock part of the adapter.

● Duplex F-type plastic cap

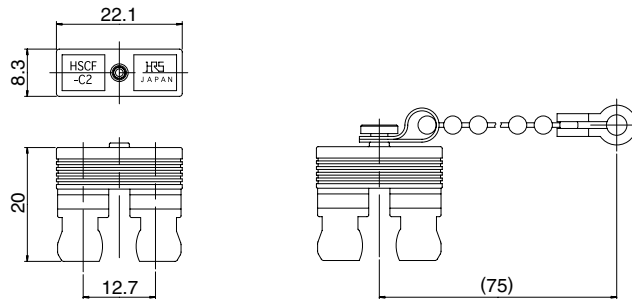

Part Number	CL No.	Remarks
HSCF-C2(40)	704-2126-2-40	without cahin
HSCF-C3(40)	704-2135-3-40	with cahin

● Duplex H-type plastic cap

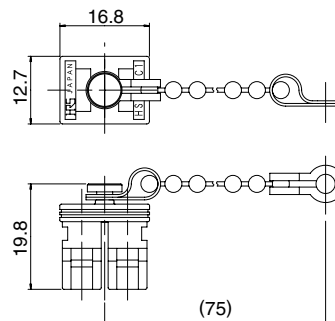

Part Number	CL No.	Remarks
HSCH-C1(40)	704-2122-1-40	with cahin

SC

FC

MU

Harsh Environment

Attenuators

Terminators

POF / PCF

## 6. Tools

### ● HSC2 Insertion/Extraction Tool



Part Number	CL No.	Applicable Products
HSC-T1-L	704-0286-8-00	HSC2 Series

Note. Handle with care because slim tips breaks easily.

#### <How to operate>

1. Open the tip of tool by compressing levers as shown below.

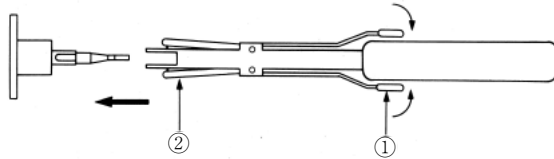

2. Insert the tool (with opening the tips) into adapter.

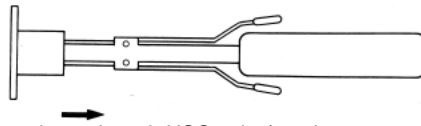

3. Release the levers (then the tool catch HSC2 plug) and you can release the connector.

### ● Extraction tool for Simplified plug (without boots)

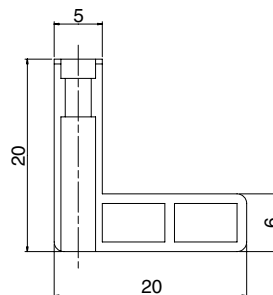
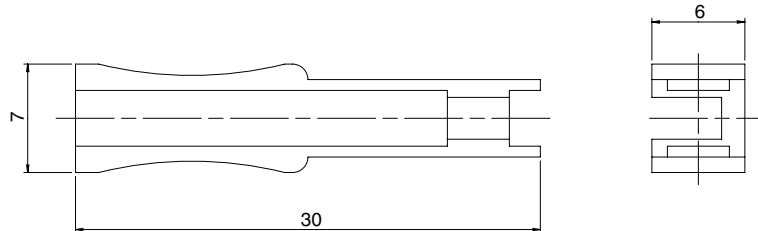
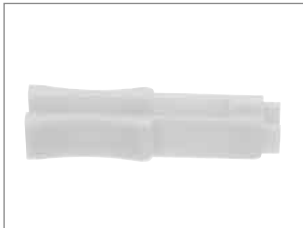

Part Number	CL No.	Shape
HSC-T13	704-0449-0-00	Straight
HSC-T8	704-0447-5-00	L type

● Extraction tool for Simplified plug (with boots)

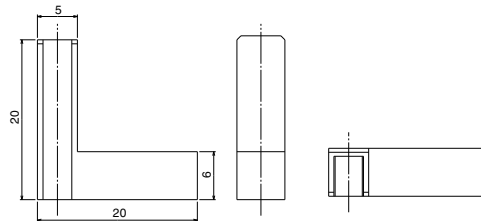
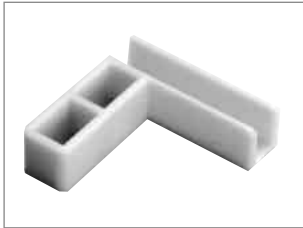
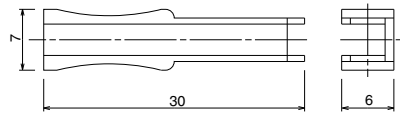
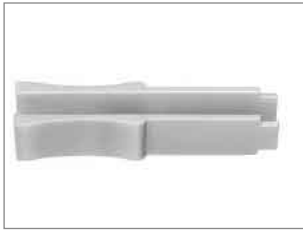

Part Number	CL No.	Shape
HSC-T10	704-0350-5-00	Straight
HSC-T12	704-0448-8-00	L type

● Crimp Tool

This is used in crimping of Kevlar or jacket at time of the plug (for cable diameter 2mm & 3mm) termination.

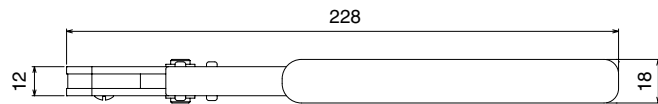
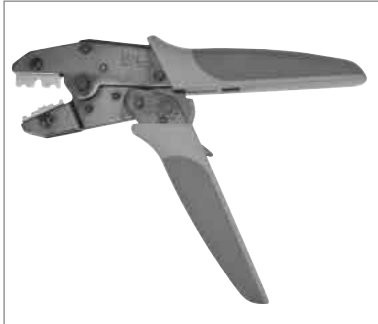

Part Number	CL No.	
HT501/HSC-T20	CL902-6064-2	(1) 2mm Jacket crimping: Please select section "2mm". 3mm Jacket crimping: Please select section "3mm". (2) Kevlar™ crimping: Please select section center round groove.

● Plug assemble tool



Part Number	CL No.
HSC2-PH2/CVMD	902-6029-1

SC

FC

MU

Harsh Environment

Attenuators

Terminators

POF / PCF

## ■ Patch cords

### ● Single mode, Polishing type: AdPC (Advanced PC)

Connector	Cable Dia.	Polishing type	Length	Part Number	CL No.
SC	φ0.9	AdPC	1m	HSC-ASPK2-F3L-1M(61)	704-1095-5-61
			2m	HSC-ASPK2-F3L-2M(62)	704-1095-5-62
			3m	HSC-ASPK2-F3L-3M(63)	704-1095-5-63
	φ2.0		1m	HSC-ASPAD2-F3Q-1M(21)	704-1170-9-21
			2m	HSC-ASPAD2-F3Q-2M(22)	704-1170-9-22
			3m	HSC-ASPAD2-F3Q-3M(23)	704-1170-9-23
FC	φ0.9		1m	HRFC-ASPA2-F3L-1M(01)	701-1073-3-01
			2m	HRFC-ASPA2-F3L-2M(02)	701-1073-3-02
			3m	HRFC-ASPA2-F3L-3M(03)	701-1073-3-03
	φ2.0		1m	HRFC-ASP72-F3Q-1M(41)	701-1059-2-41
			2m	HRFC-ASP72-F3Q-2M(42)	701-1059-2-42
			3m	HRFC-ASP72-F3Q-3M(43)	701-1059-2-43
MU	φ0.9		1m	HMUA-ASPH2-F3L-1M(61)	710-1052-4-61
			2m	HMUA-ASPH2-F3L-2M(62)	710-1052-4-62
			3m	HMUA-ASPH2-F3L-3M(63)	710-1052-4-63
	φ2.0		1m	HMUA-ASP2-F3Q-1M(70)	710-0029-7-70
			2m	HMUA-ASP2-F3Q-2M(71)	710-0029-7-71
			3m	HMUA-ASP2-F3Q-3M(72)	710-0029-7-72

### ● Single mode, Polishing type: APC (Angled PC)

Connector	Cable Dia.	Polishing type	Length	Part Number	CL No.
SC	φ2.0	APC	1m	HSC-CSPE2-F3Q-1M(21)	704-3139-0-21
			2m	HSC-CSPE2-F3Q-2M(22)	704-3139-0-22
			3m	HSC-CSPE2-F3Q-3M(23)	704-3139-0-23

### ● Multi mode, Polishing type: PC

Connector	Cable Dia.	Polishing type	Length	Part Number	CL No.
SC	φ0.9	PC	1m	HSC-SPK2-F3M7-1M(01)	704-1172-4-01
			2m	HSC-SPK2-F3M7-2M(02)	704-1172-4-02
			3m	HSC-SPK2-F3M7-3M(03)	704-1172-4-03
	φ2.0		1m	HSC-SPAD2-F3P-1M(01)	704-1173-7-01
			2m	HSC-SPAD2-F3P-2M(02)	704-1173-7-02
			3m	HSC-SPAD2-F3P-3M(03)	704-1173-7-03
FC	φ2.0		1m	HRFC-SP72-F3P-1M(51)	701-1062-7-51
			2m	HRFC-SP72-F3P-2M(52)	701-1062-7-52
			3m	HRFC-SP72-F3P-3M(53)	701-1062-7-53

Please contact HIROSE for other specifications.

## ● Patch cord structure

SC-SC

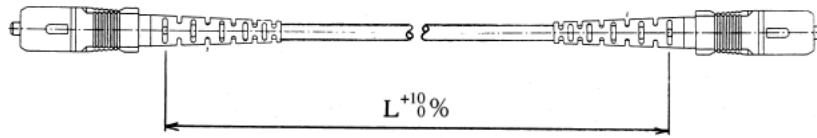

FC-FC

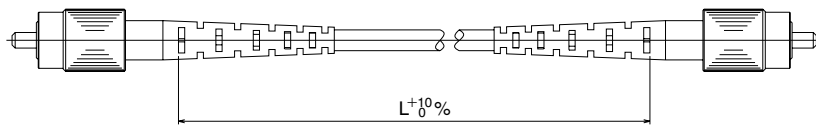

MU-MU

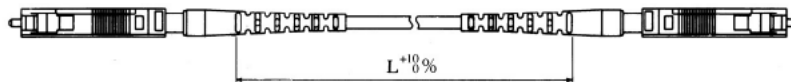

Please refer to each connector's page for SC, FC or MU type Connector's detail.

## ● Other type patch cords

Please select connector and cord specification from Table, and contact HIROSE.

Parts	Item	Specified example
Side A connector	Connector type	SC, FC, MU, LC, Simplified SC, Simplified MU
	Polishing type	AdPC, APC, PC
Side B connector	Connector type	SC, FC, MU, LC, Simplified SC, Simplified MU, None(pigtail)
	Polishing type	AdPC, APC, PC
Optical Fiber Cord	Cord style	Simplex, Duplex zipcord
	Fiber mode	SM-9.5/125, MM-50/125
	Cord diameter	φ0.9(Tight buffered), φ2, φ3
	Length	Unit: m

Please contact HIROSE for other specifications.

SC

FC

MU

Harsh  
Environment

Attenuators

Terminators

POF / PCF



# Mouser Electronics

Authorized Distributor

Click to View Pricing, Inventory, Delivery & Lifecycle Information:

## Hirose Electric:

[HSC-PH3-A2\(16\)](#) [HSC-PH3-A2\(40\)](#) [HSC-PH3-A2\(41\)](#) [HSC-PH3-A2\(46\)](#) [HSC-PH3-A2\(52\)](#) [HSC2-PH2-A2\(16\)](#)  
[HSC-A2\(44\)](#) [HSC-A2\(45\)](#) [HSC-A2\(46\)](#) [HSC-A2\(49\)](#) [HSC-A2\(50\)](#) [HSCJ-HRFCJ-B\(40\)](#) [HSCJ-HRFCJ-B\(43\)](#) [HSC-R1-B\(40\)](#) [HSC-R2-B\(40\)](#) [HSC-R2-B\(41\)](#) [HSC2-4A\(51\)](#) [HSC2-4A\(52\)](#) [HSC2-5A\(51\)](#) [HSC-P-T](#) [HSC-C2\(40\)](#) [HSC-C2\(41\)](#)  
[HSC-F321-A125\(10\)](#) [HSC-F321-A126\(10\)](#) [HSC-F321-A127](#) [HSC-F321-A128](#) [HSC-A3\(27\)](#) [HSC-A3\(40\)](#) [HSC-A3\(41\)](#) [HSC-A3\(42\)](#) [HSC-A3\(45\)](#) [HSC-A3\(50\)](#) [HSC-A3\(51\)](#) [HSC-A3\(52\)](#) [HSC-A3\(53\)](#) [HSC-A3\(55\)](#) [HSC-A3\(59\)](#)  
[HSC-A3\(60\)](#) [HSC-A3\(63\)](#) [HSC-A3\(65\)](#) [HSCJ-HRFCJ-A\(40\)](#) [HSC-C3\(40\)](#) [HSCJ-HSTJ-B\(40\)](#) [HSCJ-HSTJ-B\(42\)](#)  
[HSC-PH1-A\(40\)](#) [HSC-F321-A1255](#) [HSC-F321-A1255\(10\)](#) [HSC-F331-A1255\(20\)](#) [HSCP-HRFCJ-1\(40\)](#) [HSCP-HRFCJ-1\(41\)](#) [HSCP-HRFCJ-2\(40\)](#) [HSCP-HRFCJ-2\(41\)](#) [HSC-C4](#) [HSC-C4\(01\)](#) [HSCJ-HRFCJ-C\(40\)](#) [HSCJ-HRFCJ-C\(41\)](#)  
[HSCJ-HRFCJ-C\(43\)](#) [HSCJ-HRFCJ-C\(44\)](#) [HSC-A3-D1](#) [HSC-A3-D1\(02\)](#) [HSC-A3-D1\(03\)](#) [HSC-A3-D1\(05\)](#) [HSC-A3-D1\(06\)](#) [HSC-A3-D1\(11\)](#) [HSC-A3-D1\(21\)](#) [HSC-PH2-B1\(40\)](#) [HSC-PH2-B2\(40\)](#) [HSC-PH3-B1\(43\)](#) [HSC-PH3-B1\(45\)](#)  
[HSC-PH3-B1\(47\)](#) [HSC-PH3-B1\(48\)](#) [HSC-PH3-B2\(48\)](#) [HSC2-PH2-B1\(40\)](#) [HSC2-PH2-B2\(40\)](#) [HSC2-PH3-B1\(40\)](#)  
[HSC2-PH3-B1\(43\)](#) [HSC2-PH3-B2\(40\)](#) [HSC2-PH3-B2\(43\)](#) [HSC-PH2-A4\(40\)](#) [HSC-PH3-A4\(40\)](#) [HSC-A2-D1\(01\)](#) [HSC-A2-D1\(03\)](#) [HSC-D](#) [HSC-D\(01\)](#) [HSC2-8SR-1\(03\)](#) [HSC2-8SR-1\(08\)](#) [HSC2-8SR-1\(40\)](#) [HSC2-8SR-1\(51\)](#) [HSC2-8SR-1\(52\)](#) [HSC2-8SR-1\(53\)](#) [HSC2-FK-A125\(03\)](#) [HSC2-FK-A125\(11\)](#) [HSC2-FK-A125\(31\)](#) [HSC2-FK-A125\(32\)](#) [HSC2-FK-A125\(33\)](#) [HSC2-FK-A125\(36\)](#) [HSC2-FK-A125\(37\)](#) [HSC2-FK-A126\(03\)](#) [HSC2-FK-A126\(14\)](#) [HSC2-FK-A126\(31\)](#)