

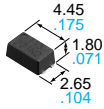

## RF (Radio Frequency) C X R 5 SSOP Type (by)

# PhotoMOS RELAYS



mm inch

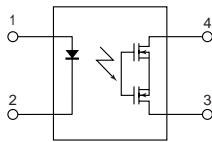

### FEATURES

#### 1. Reduced package size

Lower surface has been reduced 60% and mounting space 40% compared to conventional 4-pin SOP type.

#### 2. Lower output capacitance and on-resistance

Output capacitance(C): 1.0pF (typ.)  
ON resistance(R): 5.5Ω (typ.)

#### 3. Mounting space has been reduced and output signals have been improved by using new flat lead terminals.

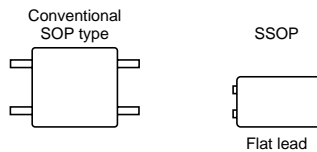

#### 4. High speed switching

Turn on time: 0.02ms  
Turn off time: 0.02ms

### TYPICAL APPLICATIONS

#### Measuring and testing equipment

1. Test equipment  
IC tester, Liquid crystal driver tester, semiconductor performance tester
2. Board tester  
Bear board tester, In-circuit tester, function tester
3. Medical equipment  
Ultrasonic wave diagnostic machine
4. Multi-point recorder  
Warping, thermo couple

### TYPES

Circuit arrangement	Type	Output rating*		Tape and reel packing style		Packing quantity in tape and reel
		Load voltage	Load current	Picked from the 1/4-pin side	Picked from the 2/3-pin side	
1 Form A	AC/DC type	25 V	150 mA	AQY221N3VY	AQY221N3VW	3,500 pcs.

\* Indicate the peak AC and DC values.

Notes: (1)Tape package is the standard packing style.

(2)For space reasons, the initial letters of the product number "AQY and V", the package type indicator "Y" and "W" are omitted from the seal.

### RATING

#### 1. Absolute maximum ratings (Ambient temperature: 25°C 77°F)

Item		Symbol	AQY221N3V	Remarks
Input	LED forward current	I <sub>F</sub>	50mA	
	LED reverse voltage	V <sub>R</sub>	5V	
	Peak forward current	I <sub>FP</sub>	1A	f=100 Hz, Duty factor=0.1%
	Power dissipation	P <sub>in</sub>	75mW	
Output	Load voltage (peak AC)	V <sub>L</sub>	25V	
	Continuous load current (peak AC)	I <sub>L</sub>	0.15A	Peak AC,DC
	Peak load current	I <sub>peak</sub>	0.4A	100 ms (1 shot), V <sub>L</sub> = DC
	Power dissipation	P <sub>out</sub>	250mW	
Total power dissipation		P <sub>T</sub>	300mW	
I/O isolation voltage		V <sub>iso</sub>	1,500V AC	
Temperature limits	Operating	T <sub>opr</sub>	-40°C to +85°C -40°F to +185°F	Non-condensing at low temperatures
	Storage	T <sub>stg</sub>	-40°C to +100°C -40°F to +212°F	

PhotoMOS Relays RF CXR5 SSOP  
ASCT1B268E '03.3

New

# AQY221N3V

## 2. Electrical characteristics (Ambient temperature: 25°C 77°F)

Item			Symbol	AQY221N3V	Condition	
Input	LED operate current	Typical	I <sub>Fon</sub>	1.0 mA	I <sub>L</sub> = 80 mA	
		Maximum		3.0 mA		
	LED turn off current	Minimum	I <sub>Foff</sub>	0.2 mA	I <sub>L</sub> = 80 mA	
		Typical		0.9 mA		
	LED dropout voltage	Typical	V <sub>F</sub>	1.14 V (1.35 V at I <sub>F</sub> = 50mA)		I <sub>F</sub> = 5mA
		Maximum		1.5 V		
Output	On resistance	Typical	R <sub>on</sub>	5.5Ω	I <sub>F</sub> = 5mA I <sub>L</sub> = 80 mA Within 1 s on time	
		Maximum		7.5Ω		
	Output capacitance	Typical	C <sub>out</sub>	1.0 pF	I <sub>F</sub> = 0 V <sub>B</sub> = 0 V f = 1 MHz	
		Maximum		1.5 pF		
	Off state leakage current	Typical	I <sub>Leak</sub>	0.01 nA	I <sub>F</sub> = 0 V <sub>L</sub> = Max.	
		Maximum		10 nA		
Transfer characteristics	Switching speed	Turn on time*	Typical	T <sub>on</sub>	0.02 ms	I <sub>F</sub> = 5mA V <sub>L</sub> = 10V R <sub>L</sub> = 125Ω
			Maximum		0.5ms	
		Turn off time*	Typical	T <sub>off</sub>	0.02ms	
			Maximum		0.2 ms	
	I/O capacitance	Typical	C <sub>iso</sub>	0.8 pF	f = 1MHz V <sub>B</sub> = 0	
		Maximum		1.5 pF		
	Initial I/O isolation resistance	Minimum	R <sub>iso</sub>	1,000MΩ	500V DC	

Note: Recommendable LED forward current I<sub>F</sub> = 5 mA.  
For type of connection, see Page 5.

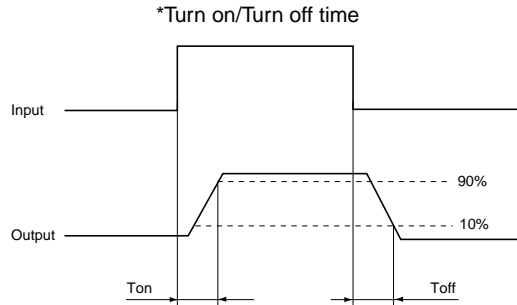

## REFERENCE DATA

### 1. Load current vs. ambient temperature characteristics

Allowable ambient temperature: -40°C to +85°C  
-40°F to +185°F

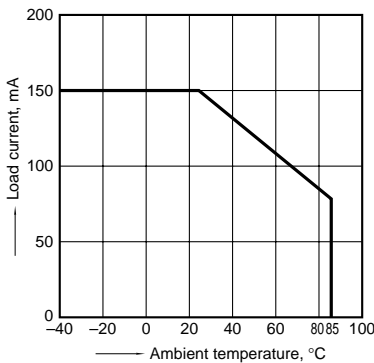

### 2. Load current vs. Load voltage characteristics

Ambient temperature: 25°C 77°F

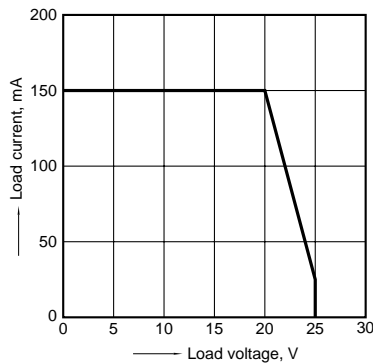

### 3. On resistance vs. ambient temperature characteristics

Measured portion: between terminals 3 and 4  
LED current: 5 mA; Load voltage: Max. (DC);  
Load current: 80mA (DC)

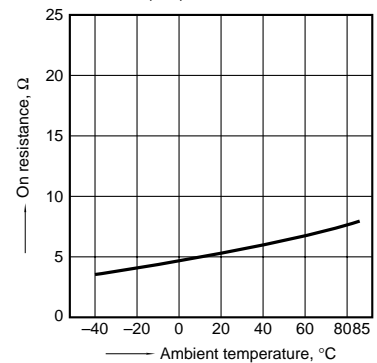

## 4. Turn on time vs. ambient temperature characteristics

Measured portion: between terminals 3 and 4  
LED current: 5 mA; Load voltage: 10V (DC);  
Continuous load current: 80mA (DC)

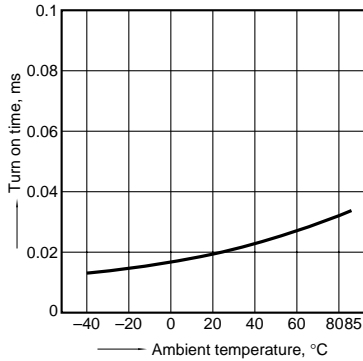

## 5. Turn off time vs. ambient temperature characteristics

LED current: 5 mA; Load voltage: 10V (DC);  
Continuous load current: 80mA (DC)

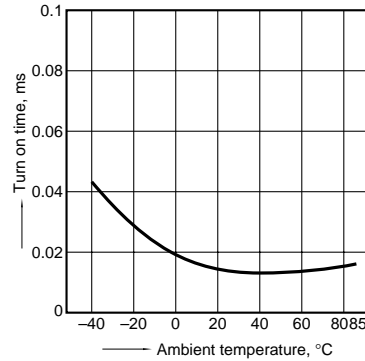

## 6. LED operate current vs. ambient temperature characteristics

Load voltage: Max. (DC);  
Continuous load current: 80mA (DC)

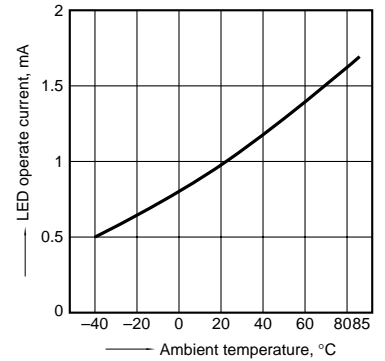

## 7. LED turn off current vs. ambient temperature characteristics

Load voltage: Max. (DC);  
Continuous load current: 80mA (DC)

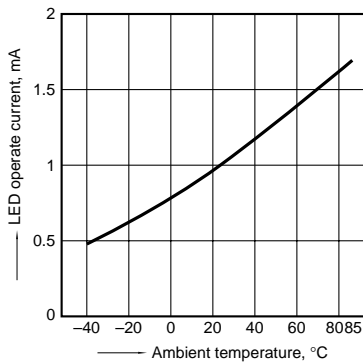

## 8. LED dropout voltage vs. ambient temperature characteristics

LED current: 5 to 50 mA

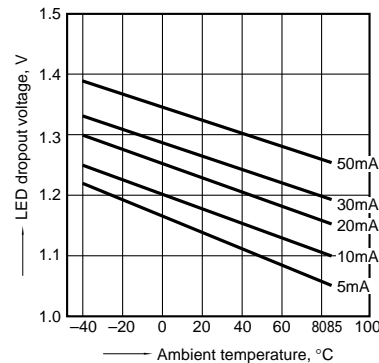

## 9. Voltage vs. current characteristics of output at MOS portion

Measured portion: between terminals 3 and 4  
Ambient temperature: 25°C 77°F

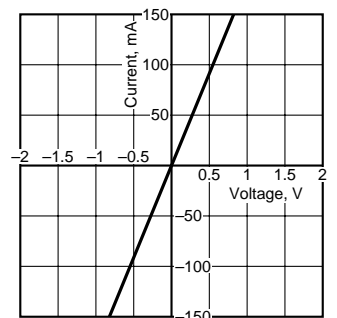

## 10. Off state leakage current

Measured portion: between terminals 3 and 4  
Ambient temperature: 25°C 77°F

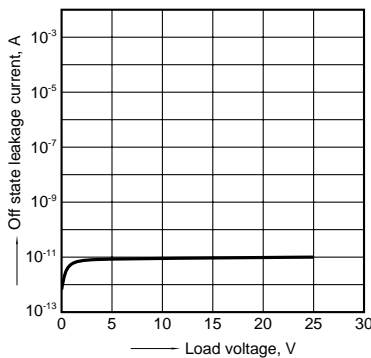

## 11. LED forward current vs. turn on time characteristics

Measured portion: between terminals 3 and 4  
Load voltage: 10V (DC); Continuous load current:  
80mA (DC); Ambient temperature: 25°C 77°F

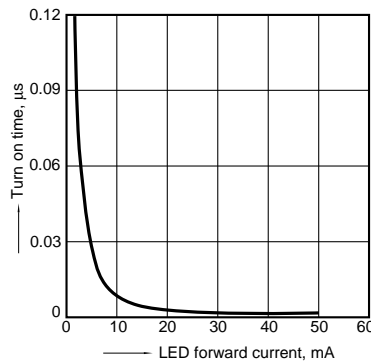

## 12. LED forward current vs. turn off time characteristics

Measured portion: between terminals 3 and 4  
Load voltage: 10V (DC); Continuous load current:  
80mA (DC); Ambient temperature: 25°C 77°F

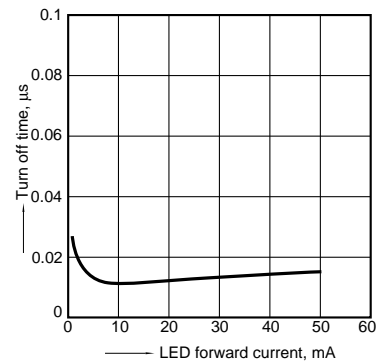

## 13. Applied voltage vs. output capacitance characteristics

Measured portion: between terminals 3 and 4  
Frequency: 1 MHz, 30m Vrms; Ambient temperature:  
25°C 77°F

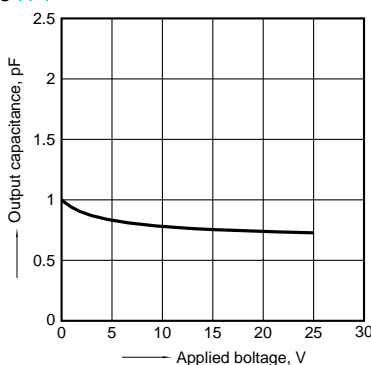

## 14. Isolation characteristics (50Ω impedance)

Measured portion: between terminals 3 and 4  
Ambient temperature: 25°C 77°F

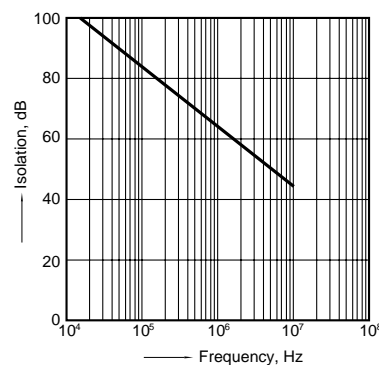

## 15. Insertion loss characteristics (50Ω impedance)

Measured portion: between terminals 3 and 4  
Ambient temperature: 25°C 77°F

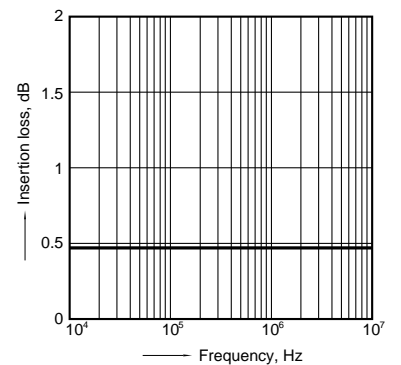

# AQY221N3V

16. On resistance distribution  
 Measured portion: between terminals 3 and 4  
 Continuous load current: 80mA (DC)  
 Quantity, n=60; Ambient temperature: 25°C 77°F

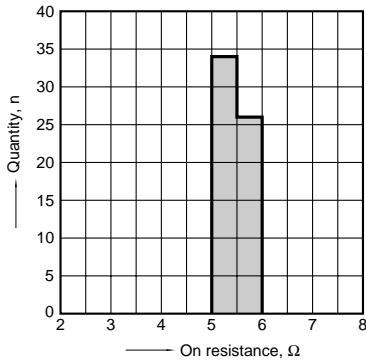

17. Turn on time distribution  
 Load voltage: 10V (DC)  
 Continuous load current: 80mA (DC)  
 Quantity, n = 60; Ambient temperature: 25°C 77°F

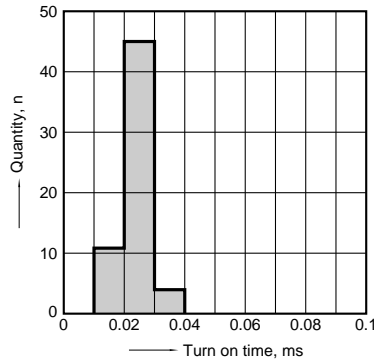

18. Turn off time distribution  
 Load voltage: 10V (DC)  
 Continuous load current: 80mA (DC)  
 Quantity, n = 60; Ambient temperature: 25°C 77°F

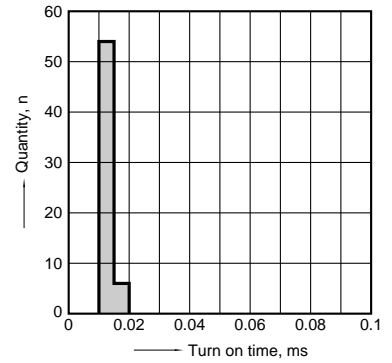

19. LED operate current distribution  
 Load voltage: 10V (DC)  
 Continuous load current: 80mA (DC)  
 Quantity, n = 60; Ambient temperature: 25°C 77°F

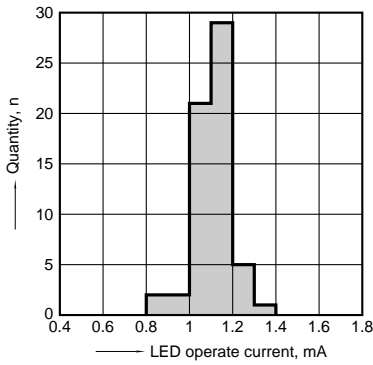

## DIMENSIONS

mm inch

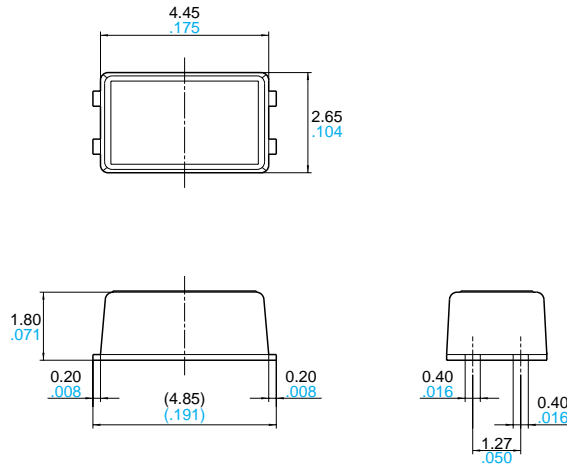

Recommended mounting pad (TOP VIEW)

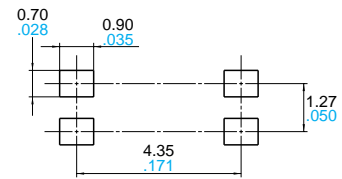

Tolerance: ±0.1 ±.004

Terminal thickness = 0.15 .006  
 General tolerance: ±0.1 ±.004

## SCHEMATIC AND WIRING DIAGRAMS

Notes: 1. E1: Power source at input side; IF: LED forward current; VL: Load voltage; IL: Load current

Schematic	Output configuration	Load	Wiring diagram
	1a	AC/DC	

## CAUTIONS FOR USE

### 1. Short across terminals

Do not short circuit between terminals when relay is energized. There is possibility of breaking the internal IC.

### 2. Surge voltages at the input

If reverse surge voltages are present at the input terminals, connect a diode in reverse parallel across the input terminals and keep the reverse voltages below the reverse breakdown voltage.

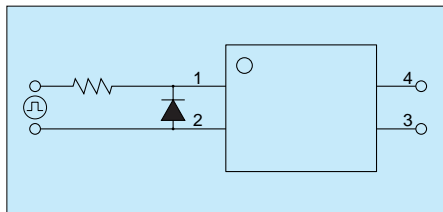

### 3. Recommended LED forward current (I<sub>F</sub>)

It is recommended that the LED forward current (I<sub>F</sub>) be kept at 5mA.

### 4. Ripple in the input power supply

If ripple is present in the input power supply, observe the following:

- 1) For LED operate current at E<sub>min</sub>, maintain the value mentioned in the table of "3. Recommended LED forward current (I<sub>F</sub>)."
- 2) Keep the LED operate current at 50 mA or less at E<sub>max</sub>.

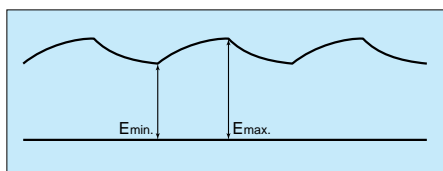

### 5. Output spike voltages

- 1) If an inductive load generates spike voltages which exceed the absolute maximum rating, the spike voltage must be limited.

Typical circuits are shown below.

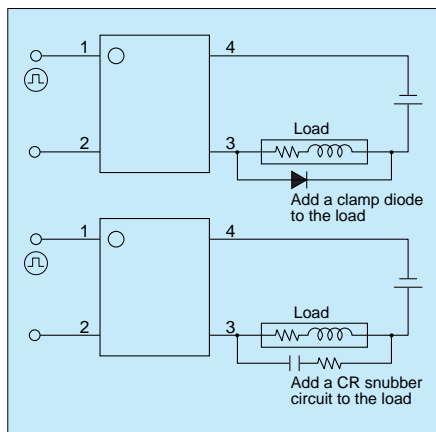

- 2) If spike voltages generated at the load are limited with a clamp diode and the circuit wires are long, spike voltages will occur by inductance.

Keep wires as short as possible to minimize inductance.

### 6. Cleaning solvents compatibility

Dip cleaning with an organic solvent is recommended for removal of solder flux, dust, etc. Select a cleaning solvent from the following table. If ultrasonic cleaning is used, the severity of factors such as frequency, output power and cleaning solvent selected may cause loose wires and other defects. Make sure these conditions are correct before use. For details, please consult us.

Cleaning solvent		Compatibility (○: Yes X: No)
Chlorine base	<ul style="list-style-type: none"> <li>• Trichlene</li> <li>• Chloroethylene</li> </ul>	○
Aqueous	<ul style="list-style-type: none"> <li>• Indusco</li> <li>• Hollis</li> <li>• Lonco Terg</li> </ul>	○
Alcohol base	<ul style="list-style-type: none"> <li>• IPA</li> <li>• Ethanol</li> </ul>	○
Others	<ul style="list-style-type: none"> <li>• Thinner</li> <li>• Gasoline</li> </ul>	X

## 7. Soldering

When soldering this terminals, the following conditions are recommended.

### (1) IR (Infrared reflow) soldering method

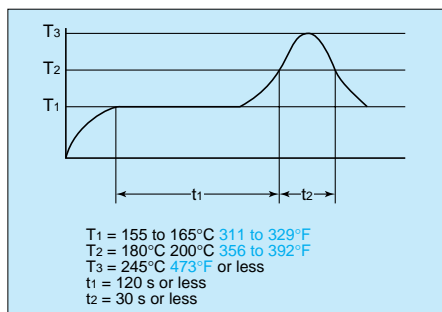

### (2) Vapor phase soldering method

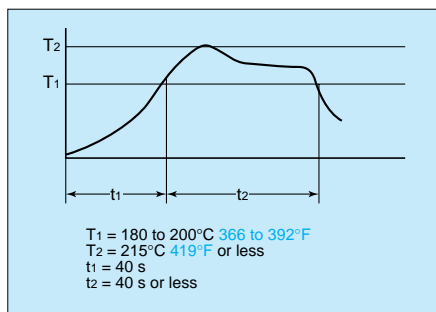

### (3) Double wave soldering method

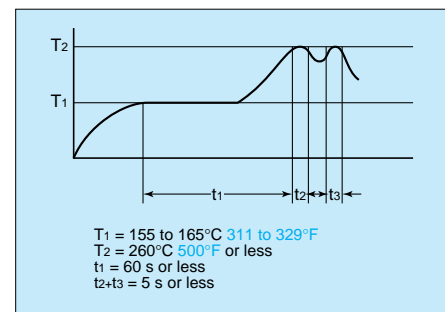

### (4) Soldering iron method

Tip temperature: 280 to 300°C

536 to 572°F

Wattage: 30 to 60 W

Soldering time: within 5 s

### (5) Others

Check mounting conditions before using other soldering methods (hot-air, hot plate, pulse heater, etc.)

- The temperature profile indicates the temperature of the soldered terminal on the surface of the PC board. The ambient

temperature may increase excessively. Check the temperature under mounting conditions.

- The conditions for the infrared reflow soldering apply when preheating using the VPS method.

# AQY221N3V

## 8. The following shows the packaging format

### 1) Tape and reel

mm inch

Type	Tape dimensions	Dimensions of paper tape reel
SSOP 4-pin type	<p>(1) When picked from 1/4-pin side: Part No. AQY○○○VY (Shown above)            (2) When picked from 2/3-pin side: Part No. AQY○○○VW</p>	

### 2) Storage

PhotoMOS relays implemented in SSOP types are sensitive to moisture and come in sealed moisture-proof packages. Observe the following cautions on storage.

- After the moisture-proof package is unsealed, take the devices out of storage as soon as possible (within 1 month at the most).

- If the devices are to be left in storage for a considerable period after the moisture-proof package has been unsealed, it is recommended to keep them in another moisture-proof bag containing silica gel (within 3 months at the most).

### 9. Transportation and storage

1) Extreme vibration during transport will warp the lead or damage the relay. Handle the outer and inner boxes with care.

2) Storage under extreme conditions will cause soldering degradation, external appearance defects, and deterioration of the characteristics. The following storage conditions are recommended:

- Temperature: 0 to 45°C **32 to 113°F**
- Humidity: Less than 70% R.H.
- Atmosphere: No harmful gasses such as sulfurous acid gas, minimal dust.

### 10. Applying stress that exceeds the absolute maximum rating

If the voltage or current value for any of the terminals exceeds the absolute maximum rating, internal elements will deteriorate because of the excessive voltage or current. In extreme cases, wiring may melt, or silicon P/N junctions may be destroyed.

As a result, the design should ensure that the absolute maximum ratings will never be exceeded, even momentarily.

(Use at 15 V DC or lower and 9 V DC or lower is recommended.)

### 11. Deterioration and destruction caused by discharge of static electricity

This phenomenon is generally called static electricity destruction. This occurs when static electricity generated by various factors is discharged while the relay terminals are in contact. The result can producing internal destruction of the element.

To prevent problems from static electricity, the following precautions and measures should be taken when using your device.

- 1) Employees handling relays should wear anti-static clothing and should be grounded through protective resistance of 500 kΩ to 1 MΩ.

2) A conductive metal sheet should be placed over the work table. Measuring instruments and jigs should be grounded.

3) When using soldering irons, either use irons with low leakage current, or ground the tip of the soldering iron. (Use of low-voltage soldering irons is also recommended.)

4) Devices and equipment used in assembly should also be grounded.

5) When packing printed circuit boards and equipment, avoid using high-polymer materials such as foam styrene, plastic, and other materials which carry an electrostatic charge.

6) When storing or transporting relays, the environment should not be conducive to generating static electricity (for instance, the humidity should be between 45 and 60%). Relays should always be protected using non-conductive packing materials.

These materials are printed on ECF pulp.  
 These materials are printed with earth-friendly vegetable-based (soybean oil) ink.



Please contact .....

## Matsushita Electric Works, Ltd.

Automation Controls Company

■ Head Office: 1048, Kadoma, Kadoma-shi, Osaka 571-8686, Japan

■ Telephone: Japan (81) Osaka (06) 6908-1050

■ Facsimile: Japan (81) Osaka (06) 6908-5781

<http://www.nais-e.com/>

COPYRIGHT © 2003 All Rights Reserved