

Amphenol® AC Threaded Series Industrial Cylindrical Connectors

12-025-6

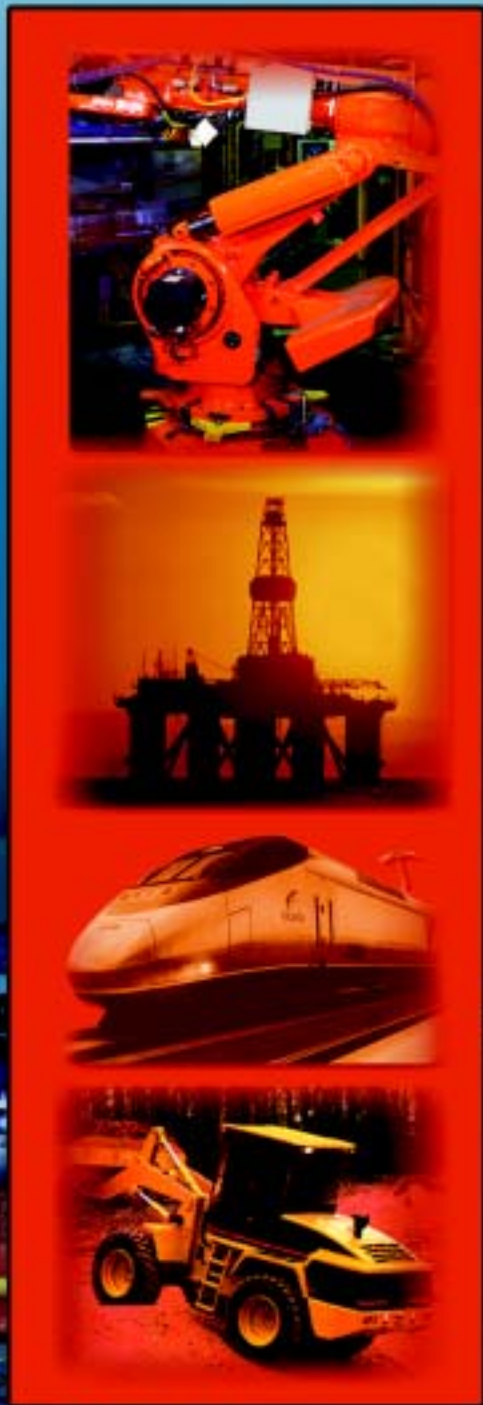

Amphenol

Table of Contents

Page

Amphenol® AC Series Connectors	
Introduction/General Information	1
AC Threaded Connector Styles	
Wall mounting receptacle	2
Line receptacle	3
Box mounting receptacle	4
Straight plug	5
90 degree plug	6
AC Series insert availability	7-9
AC Series insert alternate positioning	10
AC Series contact arrangements	11-32
AC Series accessories - sealing gaskets, sealing plugs, sealing ranges	33
AC Series solder contacts	34
AC Series crimp contacts	35
AC Series application tools, torque values	36
AC Series how to order	37
Reverse Bayonet Coupling MIL-5015 type connectors	38
AC Series Threaded Connectors with RADSOK® Contacts	39
Additional MIL-5015 Connector Products	40, 41
Sales Office Listing	back cover

For additional information on AC Series Connectors, or for special application requirements, contact your local sales office or -

Amphenol Corporation
Amphenol Industrial Operations
40 – 60 Delaware Avenue
Sidney, New York 13838-1395
Telephone: 607-563-5011
Fax: 607-563-5157
www.amphenol-industrial.com

This catalog can be viewed, printed and saved from website: www.amphenol-industrial.com. Visit this website and also www.amphenol-aerospace.com for Amphenol catalogs.

Ask for the Amphenol Industrial Connector Brochure, SL-381, for an overview of the industrial family of connectors offered.

Amphenol Brochure SL-100 provides an overview of all products, military and industrial, offered through Amphenol Aerospace and Amphenol Industrial Operations.

For specific questions about RoHS compliance, consult Amphenol Industrial Operations, or call the RoHS Product Compliance and Technical Support line: 1-866-315-8559

Amphenol Aerospace is a Certified ISO 9001 Manufacturer.

Amphenol® AC Series

industrial application threaded style connector

AC Threaded Series

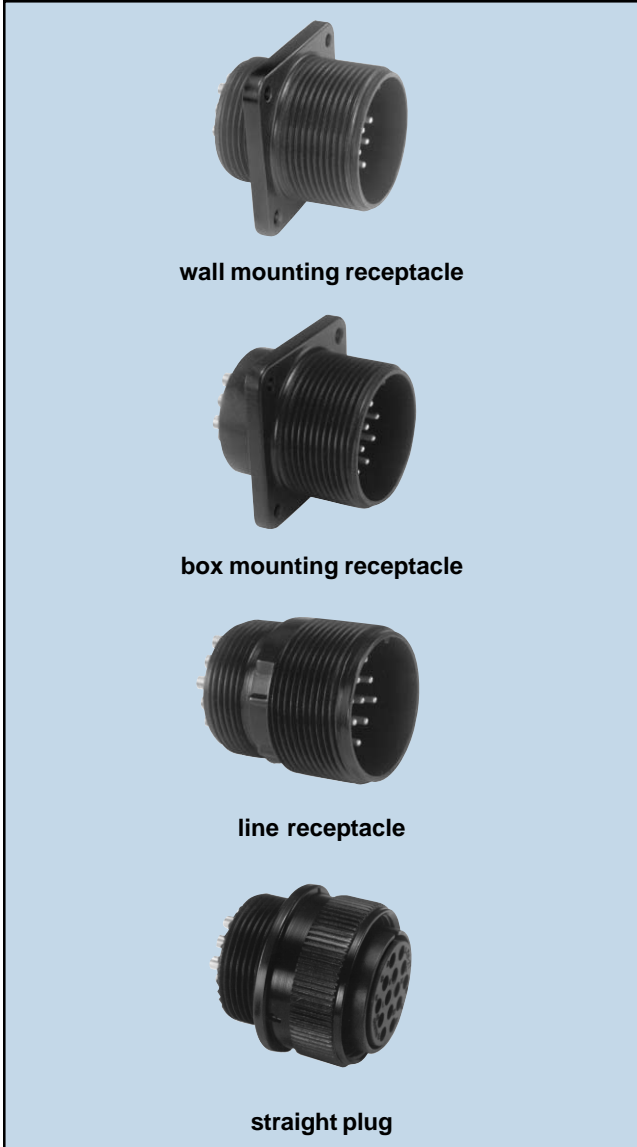

wall mounting receptacle

box mounting receptacle

line receptacle

straight plug

AC Threaded Connectors with RADSOK® High Amperage Contacts



Designed with the industrial user in mind, for widely diverse applications such as mass transportation, automotive, heavy equipment and geophysical industries, and for the entertainment/ lighting industries, the new AC Series of Connectors offer the following features:

- Rugged aluminum shells
- Durability and reliability
- Environmentally acceptable shell plating options -
 - Conductive and non-conductive
- Single key/keyway shell polarization
- Five shell styles in sizes 10SL to 40
- Threaded coupling
- Various backshells
- Resilient inserts -
 - Outstanding moisture barrier
 - High dielectric strength
 - High resistance to vibration
- Over 275 insert patterns available
- Alternate insert positioning
- Machined contacts -
 - Maximum corrosion resistance
 - Maximum current capacity
 - Low millivolt drop
- Solder and crimp contacts - silver plated or optional gold plating
- General duty and environmental versions
- -55° C to +125° C operating temp. range
- Standard application tools

Ampe-Power™ Connectors - AC Threaded Connectors with RADSOK® contacts are also available. These are high amperage capability connectors designed for the most demanding industrial and transportation applications.

- The RADSOK contact will handle up to 150% higher amperages than standard contacts.
- Current Ampe-Power lines support from 50A to 500A continuous duty.
- RADSOK contacts are available in size 8 (69 amps), size 4 (120 amps), and size 0 (250 amps).

See page 39 for more information.

Note: The previous AC-B Bayonet series is replaced by the newer ACA-B Reverse Bayonet series. For availability of the AC-B, consult Amphenol Industrial Operations. For information on ACA-B Reverse Bayonet series connectors see page 38, or Amphenol catalog 12-027.



RoHS Compliant options available. See page 37 for information.

AC Threaded wall mounting receptacle

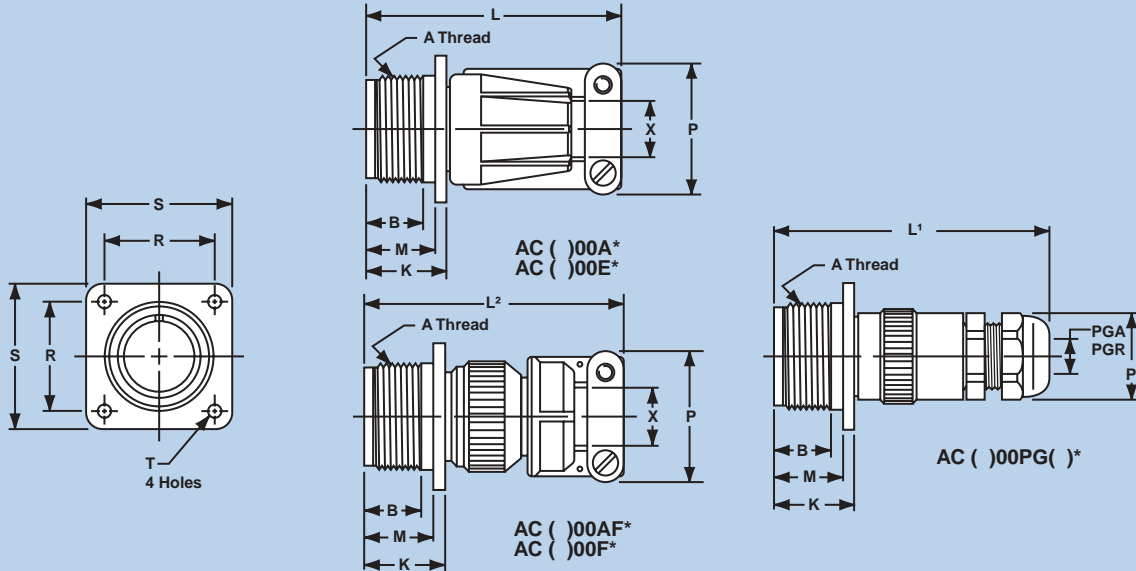

* To complete order number, see how to order, page 37.

Inches

Shell Size	A Thread Class 2A	B Min Full Thread	K +.020 -.010	L Max	L' Max	L ² Max	M +.010 -.000	P Max	P ¹ Hex Flats Ref	PGA Ref	PGR Ref	R ±.005	S ±.010	T Dia +.004 -.002	X Max O.D. Cable
10SL	.6250-24UNEF	.391	.672	2.129	3.010	2.189	.562	.894	.750	.150/.320	.070/.240	.719	1.000	.120	.312
12S	.7500-20UNEF	.450	.672	2.129	3.010	2.261	.562	.894	.750	.150/.320	.070/.240	.812	1.094	.120	.312
12	.7500-20UNEF	.625	.860	2.524	3.500	2.644	.750	.894	.750	.150/.320	.070/.240	.812	1.094	.120	.312
14S	.8750-20UNEF	.450	.672	2.201	3.188	2.261	.562	1.083	.880	.190/.390	.110/.280	.906	1.188	.120	.438
14	.8750-20UNEF	.625	.860	2.524	3.641	2.644	.750	1.083	.880	.190/.390	.110/.280	.906	1.188	.120	.438
16S	1.0000-20UNEF	.450	.672	2.201	3.265	2.266	.562	1.181	.940	.230/.470	.190/.350	.969	1.281	.120	.531
16	1.0000-20UNEF	.625	.860	2.524	3.718	2.644	.750	1.181	.940	.230/.470	.190/.350	.969	1.281	.120	.531
18	1.1250-18UNEF	.625	.891	2.596	3.718	2.716	.750	1.300	.940	.230/.470	.190/.350	1.063	1.375	.120	.625
20	1.2500-18UNEF	.625	.891	2.654	3.798	2.774	.750	1.487	1.060	.390/.560	.270/.470	1.156	1.500	.120	.750
22	1.3750-18UNEF	.625	.891	2.654	4.080	2.916	.750	1.487	1.060	.390/.560	.270/.470	1.250	1.625	.120	.750
24	1.5000-18UNEF	.625	.953	2.885	4.142	3.051	.812	1.712	1.060	.390/.560	.270/.470	1.375	1.750	.147	.938
28	1.7500-18UNS	.625	.953	2.885	4.291	3.140	.812	1.712	1.300	.510/.710	.350/.630	1.562	2.000	.147	.938
32	2.0000-18UNS	.625	1.031	2.943	4.643	3.184	.875	2.063	1.650	.700/.980	.510/.790	1.750	2.250	.173	1.250
36	2.2500-16UN	.625	1.031	2.943	4.643	3.245	.875	2.283	1.650	.700/.980	.510/.790	1.938	2.500	.173	1.375
40	2.5000-16UN	.625	1.031	3.068	5.635	3.670	.875	2.688	1.650	.700/.980	.510/.790	2.188	2.750	.173	1.625

Millimeters

Shell Size	B Min Full Thread	K +.51 -.25	L Max	L' Max	L ² Max	M +.25 -.00	P Max	P ¹ Hex Flats Ref	PGA Ref	PGR Ref	R ±.13	S ±.25	T Dia +.10 -.05	X Max O.D. Cable
10SL	9.93	17.07	54.08	76.45	55.60	14.28	22.71	19.05	3.81/8.13	1.78/6.10	18.26	25.40	3.05	7.93
12S	11.43	17.07	54.08	76.45	57.43	14.28	22.71	19.05	3.81/8.13	1.78/6.10	20.63	27.79	3.05	7.93
12	15.88	21.84	64.11	88.90	67.16	19.05	22.71	19.05	3.81/8.13	1.78/6.10	20.63	27.79	3.05	7.93
14S	11.43	17.07	55.91	80.98	57.43	14.28	27.51	22.35	4.83/9.91	2.79/7.11	23.01	30.18	3.05	11.13
14	15.88	21.84	64.11	92.48	67.16	19.05	27.51	22.35	4.83/9.91	2.79/7.11	23.01	30.18	3.05	11.13
16S	11.43	17.07	55.91	82.93	57.56	14.28	30.00	23.88	5.84/11.94	4.83/8.89	24.61	32.54	3.05	13.49
16	15.88	21.84	64.11	94.44	67.16	19.05	30.00	23.88	5.84/11.94	4.83/8.89	24.61	32.54	3.05	13.49
18	15.88	22.63	65.94	94.44	68.99	19.05	33.02	23.88	5.84/11.94	4.83/8.89	27.00	34.93	3.05	15.88
20	15.88	22.63	67.41	96.47	70.46	19.05	37.77	26.92	9.91/14.22	6.86/11.94	29.36	38.10	3.05	19.05
22	15.88	22.63	67.41	103.63	74.07	19.05	37.77	26.92	9.91/14.22	6.86/11.94	31.75	41.28	3.05	19.05
24	15.88	24.21	73.28	105.21	77.50	20.63	43.49	26.92	9.91/14.22	6.86/11.94	34.93	44.45	3.73	23.83
28	15.88	24.21	73.28	108.99	79.76	20.63	43.49	33.02	12.95/18.03	8.89/16.00	39.68	50.80	3.73	23.83
32	15.88	26.19	74.75	117.93	80.87	22.23	52.40	41.91	17.78/24.89	12.95/20.07	44.45	57.15	4.39	31.75
36	15.88	26.19	74.75	117.93	82.42	22.23	57.99	41.91	17.78/24.89	12.95/20.07	49.23	63.50	4.39	34.93
40	15.88	26.19	77.93	143.13	93.22	22.23	68.28	41.91	17.78/24.89	12.95/20.07	55.58	69.85	4.39	41.28

All dimensions for reference only.

AC Threaded line receptacle

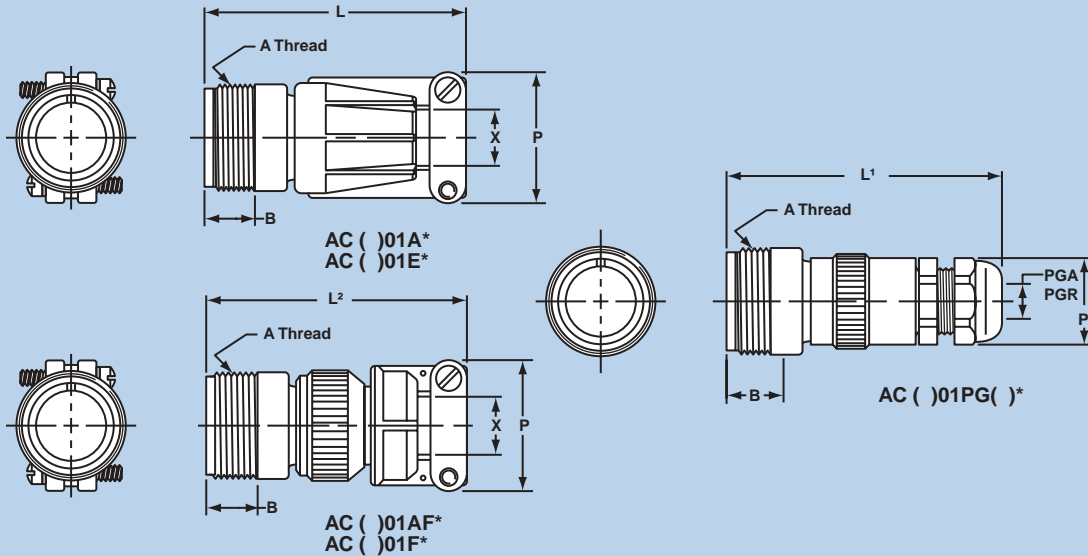

* To complete order number, see how to order, page 37.

Inches

Shell Size	A Thread Class 2 A	B Min Full Thread	L Max	L' Max	L ² Max	P Max	P ¹ HexFlats Ref	PGA Ref	PGR Ref	X Max O.D. Cable
10SL	.6250-24UNEF	.406	2.129	3.010	2.189	.894	.750	.150/.320	.070/.240	.312
12S	.7500-20UNEF	.422	2.129	3.010	2.261	.894	.750	.150/.320	.070/.240	.312
12	.7500-20UNEF	.656	2.524	3.500	2.644	.894	.750	.150/.320	.070/.240	.312
14S	.8750-20UNEF	.391	2.201	3.188	2.261	1.083	.880	.190/.390	.110/.280	.438
14	.8750-20UNEF	.625	2.524	3.641	2.644	1.083	.880	.190/.390	.110/.280	.438
16S	1.0000-20UNEF	.391	2.201	3.265	2.266	1.181	.940	.230/.470	.190/.350	.531
16	1.0000-20UNEF	.625	2.524	3.718	2.644	1.181	.940	.230/.470	.190/.350	.531
18	1.1250-18UNEF	.625	2.596	3.718	2.716	1.300	.940	.230/.470	.190/.350	.625
20	1.2500-18UNEF	.625	2.654	3.798	2.774	1.487	1.060	.390/.560	.270/.470	.750
22	1.3750-18UNEF	.625	2.654	4.080	2.916	1.487	1.060	.390/.560	.270/.470	.750
24	1.5000-18UNEF	.625	2.885	4.142	3.051	1.712	1.060	.390/.560	.270/.470	.938
28	1.7500-18UNS	.625	2.885	4.291	3.140	1.712	1.300	.510/.710	.350/.630	.938
32	2.0000-18UNS	.625	2.943	4.643	3.184	2.063	1.650	.700/.980	.510/.790	1.250
36	2.2500-16UN	.625	2.943	4.643	3.245	2.283	1.650	.700/.980	.510/.790	1.375
40	2.5000-16UN	.625	3.068	5.635	3.670	2.688	1.650	.700/.980	.510/.790	1.625

Millimeters

Shell Size	B Min Full Thread	L Max	L' Max	L ² Max	P Max	P ¹ Hex Flats Ref	PGA Ref	PGR Ref	X Max O.D. Cable
10SL	10.31	54.08	76.45	55.60	22.71	19.05	3.81/8.13	1.78/6.10	7.93
12S	10.72	54.08	76.45	57.43	22.71	19.05	3.81/8.13	1.78/6.10	7.93
12	16.66	64.11	88.90	67.16	22.71	19.05	3.81/8.13	1.78/6.10	7.93
14S	9.93	55.91	80.98	57.43	27.51	22.35	4.83/9.91	2.79/7.11	11.13
14	15.88	64.11	92.48	67.16	27.51	22.35	4.83/9.91	2.79/7.11	11.13
16S	9.93	55.91	82.93	57.56	30.00	23.88	5.84/11.94	4.83/8.89	13.49
16	15.88	64.11	94.44	67.16	30.00	23.88	5.84/11.94	4.83/8.89	13.49
18	15.88	65.94	94.44	68.99	33.02	23.88	5.84/11.94	4.83/8.89	15.88
20	15.88	67.41	96.47	70.46	37.77	26.92	9.91/14.22	6.86/11.94	19.05
22	15.88	67.41	103.63	74.07	37.77	26.92	9.91/14.22	6.86/11.94	19.05
24	15.88	73.28	105.21	77.50	43.49	26.92	9.91/14.22	6.86/11.94	23.83
28	15.88	73.28	108.99	79.76	43.49	33.02	12.95/18.03	8.89/16.00	23.83
32	15.88	74.75	117.93	80.87	52.40	41.91	17.78/24.89	12.95/20.07	31.75
36	15.88	74.75	117.93	82.42	57.99	41.91	17.78/24.89	12.95/20.07	34.93
40	15.88	77.93	143.13	93.22	68.28	41.91	17.78/24.89	12.95/20.07	41.28

All dimensions for reference only.

AC Threaded box mounting receptacle

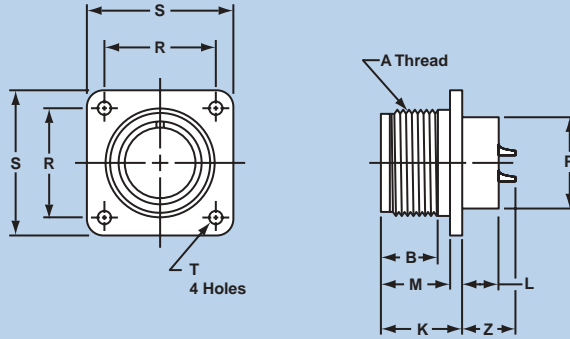

AC ()02A*
AC ()02E*

* To complete order number, see how to order, page 37.

Inches

Shell Size	A Thread Class 2 A	B Min Full Thread	K +.020 -0.010	L +.000 -0.010	M +.010 -0.000	P Dia +.010 -0.000	R ±.005	S ±.031	T Dia +.004 -0.002	Z Max**
8S	.5000-28UNEF	.391	.672	.297	.562	.375	.594	.875	.120	.519
10S	.6250-24NEF	.391	.672	.297	.562	.500	.719	1.000	.120	.519
10SL	.6250-24NEF	.391	.672	.297	.562	.625	.719	1.000	.120	.519
12S	.7500-20UNEF	.450	.672	.297	.562	.625	.812	1.094	.120	.519
12	.7500-20UNEF	.625	.860	.484	.750	.625	.812	1.094	.120	.722
14S	.8750-20UNEF	.450	.672	.297	.562	.750	.906	1.188	.120	.519
14	.8750-20UNEF	.625	.860	.484	.750	.750	.906	1.188	.120	.722
16S	1.0000-20UNEF	.450	.672	.297	.562	.875	.969	1.281	.120	.519
16	1.0000-20UNEF	.625	.860	.484	.750	.875	.969	1.281	.120	.722
18	1.1250-18NEF	.625	.891	.453	.750	1.000	1.062	1.375	.120	.691
20	1.2500-18NEF	.625	.891	.453	.750	1.125	1.156	1.500	.120	.691
22	1.3750-18NEF	.625	.891	.453	.750	1.250	1.250	1.625	.120	.691
24	1.5000-18NEF	.625	.953	.453	.812	1.375	1.375	1.750	.147	.628
28	1.7500-18NS	.625	.953	.453	.812	1.625	1.562	2.000	.147	.628
32	2.0000-18NS	.625	1.031	.438	.875	1.875	1.750	2.250	.173	.550
36	2.2500-16UN	.625	1.031	.438	.875	2.062	1.938	2.500	.173	.550
40	2.5000-16UN	.625	1.031	.438	.875	2.312	2.188	2.750	.173	.550

Millimeters

Shell Size	B Min Full Thread	K +.51 -0.25	L +.00 -0.25	M +.25 -0.00	P Dia +.25 -0.00	R ±.13	S ±.79	T Dia +.10 -0.05	Z Max**
8S	9.93	17.07	7.54	14.28	9.53	15.09	22.23	3.05	13.18
10S	9.93	17.07	7.54	14.28	12.70	18.26	25.40	3.05	13.18
10SL	9.93	17.07	7.54	14.28	15.88	18.26	25.40	3.05	13.18
12S	11.43	17.07	7.54	14.28	15.88	20.63	27.79	3.05	13.18
12	15.88	21.84	12.29	19.05	15.88	20.63	27.79	3.05	18.34
14S	11.43	17.07	7.54	14.28	19.05	23.01	30.18	3.05	13.18
14	15.88	21.84	12.29	19.05	19.05	23.01	30.18	3.05	18.34
16S	11.43	17.07	7.54	14.28	22.23	24.61	32.54	3.05	13.18
16	15.88	21.84	12.29	19.05	22.23	24.61	32.54	3.05	18.34
18	15.88	22.63	11.51	19.05	25.40	26.98	34.93	3.05	17.55
20	15.88	22.63	11.51	19.05	28.58	29.36	38.10	3.05	17.55
22	15.88	22.63	11.51	19.05	31.75	31.75	41.28	3.05	17.55
24	15.88	24.21	11.51	20.63	34.93	34.93	44.45	3.73	15.95
28	15.88	24.21	11.51	20.63	41.28	39.68	50.80	3.73	15.95
32	15.88	26.19	11.13	22.23	47.63	44.45	57.15	4.39	13.97
36	15.88	26.19	11.13	22.23	52.38	49.23	63.50	4.39	13.97
40	15.88	26.19	11.13	22.23	58.73	55.58	69.85	4.39	13.97

** Increase Z dimension by .312 for size "0" contact only.

All dimensions for reference only.

AC Threaded straight plug

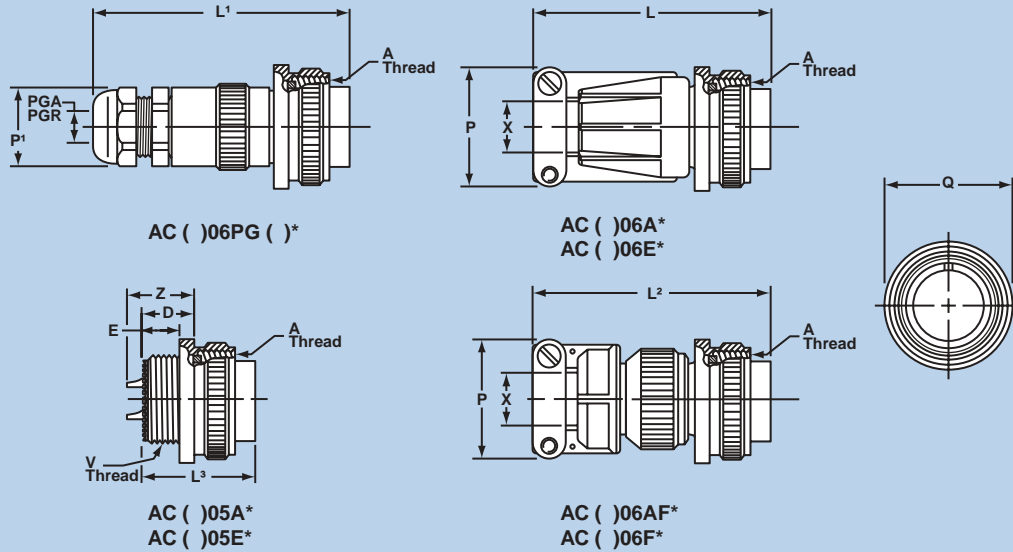

* To complete order number, see how to order, page 37.

Inches

Shell Size	A Thread Class 2B	D ±.010	E +.020 -0.030	L Max	L' Max	L ² Max	L ³ Max	P Max	P ¹ Hex Flats Ref	PGA Ref	PGR Ref	Q Max	VThread Plated Class 2A	X Max O.D. Cable	Z ±.045
10SL	.6250-24UNEF	.438	.298	2.129	3.010	2.189	.989	.894	.750	.150/.320	.070/.240	.946	.6250-24UNEF	.312	.562
12S	.7500-20UNEF	.438	.312	2.129	3.010	2.261	.989	.894	.750	.150/.320	.070/.240	.995	.6250-24UNEF	.312	.562
12	.7500-20UNEF	.625	.469	2.524	3.500	2.644	1.364	.894	.750	.150/.320	.070/.240	.995	.6250-24UNEF	.312	.812
14S	.8750-20UNEF	.438	.312	2.201	3.188	2.261	.989	1.083	.880	.190/.390	.110/.280	1.123	.7500-20UNEF	.438	.562
14	.8750-20UNEF	.625	.469	2.524	3.641	2.644	1.364	1.083	.880	.190/.390	.110/.280	1.123	.7500-20UNEF	.438	.812
16S	1.0000-20UNEF	.438	.312	2.201	3.265	2.266	.989	1.181	.940	.230/.470	.190/.350	1.250	.8750-20UNEF	.531	.562
16	1.0000-20UNEF	.625	.469	2.524	3.718	2.644	1.364	1.181	.940	.230/.470	.190/.350	1.250	.8750-20UNEF	.531	.812
18	1.1250-18UNEF	.625	.469	2.596	3.718	2.716	1.364	1.300	.940	.230/.470	.190/.350	1.333	1.0000-20UNEF	.625	.812
20	1.2500-18UNEF	.625	.469	2.654	3.798	2.774	1.364	1.487	1.060	.390/.560	.270/.470	1.461	1.1250-18UNEF	.750	.812
22	1.3750-18UNEF	.625	.469	2.654	4.080	2.916	1.364	1.487	1.060	.390/.560	.270/.470	1.588	1.2500-18UNEF	.750	.812
24	1.5000-18UNEF	.688	.469	2.885	4.142	3.051	1.427	1.712	1.060	.390/.560	.270/.470	1.715	1.3750-18UNEF	.938	.812
28	1.7500-18UNS	.688	.469	2.885	4.291	3.140	1.427	1.712	1.300	.510/.710	.350/.630	1.968	1.6250-18UNEF	.938	.812
32	2.0000-18UNS	.750	.469	2.943	4.643	3.184	1.489	2.063	1.650	.700/.980	.510/.790	2.209	1.8750-16UN	1.250	.812
36	2.2500-16UN	.750	.469	2.943	4.643	3.245	1.489	2.283	1.650	.700/.980	.510/.790	2.463	2.0625-16UN	1.375	.812
40	2.5000-16UN	.750	.469	3.068	5.635	3.670	1.489	2.688	1.650	.700/.980	.510/.790	2.718	2.3125-16UN	1.625	.812

Millimeters

Shell Size	D ±.25	E +.51 -0.76	L Max	L' Max	L ² Max	L ³ Max	P Max	P ¹ Hex Flats Ref	PGA Ref	PGR Ref	Q Max	X Max O.D. Cable	Z ±1.14
10SL	11.13	7.57	54.08	76.45	55.60	25.12	22.71	19.05	3.81/8.13	1.78/6.10	24.03	7.93	14.28
12S	11.13	7.93	54.08	76.45	57.43	25.12	22.71	19.05	3.81/8.13	1.78/6.10	25.27	7.93	14.28
12	15.88	11.91	64.11	88.90	67.16	34.65	22.71	19.05	3.81/8.13	1.78/6.10	25.27	7.93	20.63
14S	11.13	7.93	55.91	80.98	57.43	25.12	27.51	22.35	4.83/9.91	2.79/7.11	28.52	11.13	14.28
14	15.88	11.91	64.11	92.48	67.16	34.65	27.51	22.35	4.83/9.91	2.79/7.11	28.52	11.13	20.63
16S	11.13	7.93	55.91	82.93	57.56	25.12	30.00	23.88	5.84/11.94	4.83/8.89	31.75	13.49	14.28
16	15.88	11.91	64.11	94.44	67.16	34.65	30.00	23.88	5.84/11.94	4.83/8.89	31.75	13.49	20.63
18	15.88	11.91	65.94	94.44	68.99	34.65	33.02	23.88	5.84/11.94	4.83/8.89	33.86	15.88	20.63
20	15.88	11.91	67.41	96.47	70.46	34.65	37.77	26.92	9.91/14.22	6.86/11.94	37.11	19.05	20.63
22	15.88	11.91	67.41	103.63	74.07	34.65	37.77	26.92	9.91/14.22	6.86/11.94	40.34	19.05	20.63
24	17.48	11.91	73.28	105.21	77.50	36.25	43.49	26.92	9.91/14.22	6.86/11.94	43.56	23.83	20.63
28	17.48	11.91	73.28	108.99	79.76	36.25	43.49	33.02	12.95/18.03	8.89/16.00	49.99	23.83	20.63
32	19.05	11.91	74.75	117.93	80.87	37.82	52.40	41.91	17.78/24.89	12.95/20.07	56.11	31.75	20.63
36	19.05	11.91	74.75	117.93	82.42	37.82	57.99	41.91	17.78/24.89	12.95/20.07	62.56	34.93	20.63
40	19.05	11.91	77.93	143.13	93.22	37.82	68.28	41.91	17.78/24.89	12.95/20.07	69.04	41.28	20.63

All dimensions for reference only.

AC Threaded 90 degree plug

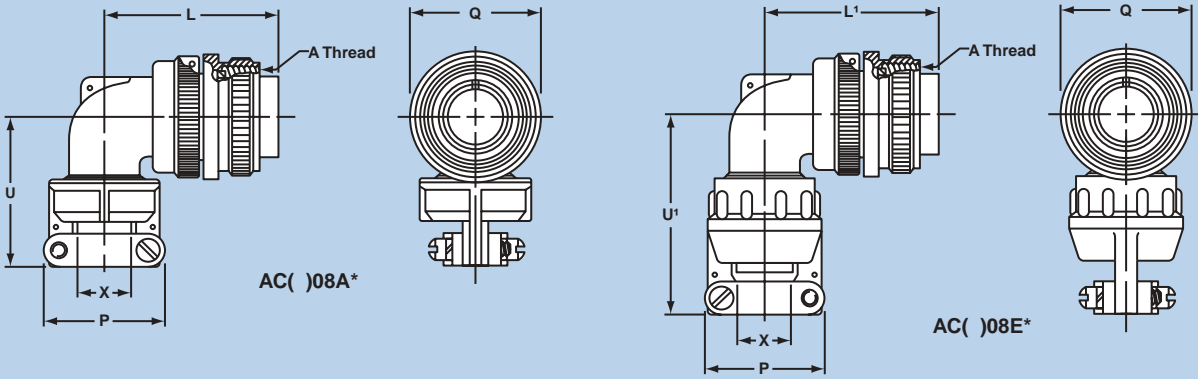

* To complete order number, see how to order, page 37.

Inches

Shell Size	A Thread Class 2B	L Max	L' Max	P Max	Q Dia Max	U Max	U' Max	X Max O.D. Cable
10SL	.6250-24NEF	1.492	1.492	.906	.946	1.305	1.812	.312
12S	.7500-20UNEF	1.492	1.492	.906	.995	1.305	1.812	.312
12	.7500-20UNEF	1.867	1.867	.906	.995	1.305	1.812	.312
14S	.8750-20UNEF	1.556	1.556	1.031	1.123	1.485	1.875	.438
14	.8750-20UNEF	1.931	1.931	1.031	1.123	1.485	1.875	.438
16S	1.0000-20UNEF	1.682	1.682	1.125	1.250	1.612	1.937	.531
16	1.0000-20UNEF	2.057	2.057	1.125	1.250	1.612	1.937	.531
18	1.1250-18NEF	2.119	2.119	1.234	1.333	1.738	2.109	.625
20	1.2500-18NEF	2.369	2.322	1.484	1.461	1.800	2.187	.750
22	1.3750-18NEF	2.369	2.322	1.484	1.588	1.862	2.250	.750
24	1.5000-18NEF	2.620	2.510	1.683	1.715	2.100	2.484	.938
28	1.7500-18NS	2.620	2.510	1.683	1.968	2.162	2.546	.938
32	2.0000-18NS	2.842	2.744	2.188	2.209	2.405	3.045	1.250
36	2.2500-16UN	2.900	2.869	2.344	2.463	2.536	3.218	1.375
40	2.5000-16UN	3.025	2.994	2.688	2.719	3.206	3.375	1.625

Millimeters

Shell Size	L Max	L' Max	P Max	Q Dia Max	U Max	U' Max	X Max O.D. Cable
10SL	37.90	37.90	23.01	24.03	33.15	46.03	7.93
12S	37.90	37.90	23.01	25.27	33.15	46.03	7.93
12	47.42	47.42	23.01	25.27	33.15	46.03	7.93
14S	39.52	39.52	26.19	28.52	37.72	47.63	11.13
14	49.05	49.05	26.19	28.52	37.72	47.63	11.13
16S	42.72	42.72	28.58	31.75	40.95	49.20	13.49
16	52.25	52.25	28.58	31.75	40.95	49.20	13.49
18	53.82	53.82	31.34	33.86	44.15	53.57	15.88
20	60.17	58.98	37.69	37.11	45.72	55.55	19.05
22	60.17	58.98	37.69	40.34	47.30	57.15	19.05
24	66.55	63.75	42.75	43.56	53.34	63.09	23.83
28	66.55	63.75	42.75	49.99	54.92	64.67	23.83
32	72.19	69.70	55.58	56.11	61.09	77.34	31.75
36	73.66	72.87	59.54	62.56	64.41	81.74	34.93
40	76.84	76.05	68.28	69.06	81.43	85.73	41.28

All dimensions for reference only.

AC Series

insert availability

Insert Arrangement	Service Rating	Total Contacts	Contact Size				
			0	4	8	12	16
10SL-3	A	3					3
10SL-4†	A	2					2
12S-3	A	2					2
12S-4	D	1					1
12-5	D	1				1	
14S-1	A	3					3
14S-2	Inst.	4					4
14S-4	D	1					1
14S-5	Inst.	5					5
14S-6	Inst.	6					6
14S-7	A	3					3
14S-9	A	2					2
14S-10	Inst.	4					4
14S-12	A	3					3
14S-A7	A	7					7
14-3	A	1			1		
16S-1	A	7					7
16S-3	B	1					1
16S-4	D	2					2
16S-5	A	3					3
16S-6	A	3					3
16S-8	A	5					5
16-2	E	1				1	
16-7	A	3			1		2
16-9	A	4				2	2
16-10	A	3				3	
16-11	A	2				2	
16-12	A	1		1			
16-13	A	2				2	
16-59	A	4				4	
18-1	A/Inst.	10					10
18-3	D	2				2	
18-4	D	4					4
18-5	D	3				2	1
18-6	D	1		1			
18-7	B	1			1		
18-8	A	8				1	7
18-9	Inst.	7				2	5
18-10	A	4				4	
18-11	A	5				5	
18-12	A	6					6
18-13	A	4			1	3	
18-14	A	2		1			1
18-15	A	4				4	
18-16	C	1				1	
18-17	Inst.	7				2	5
18-19	A	10					10
18-20	A	5					5
18-22	D	3					3
18-24	A/Inst.	10					10
18-29	A	5					5

† 10SL-4 arrangement available only with pin contacts in receptacle and socket contacts in plug.

Insert Arrangement	Service Rating	Total Contacts	Contact Size				
			0	4	8	12	16
18-30	A	5					5
18-31	A	5					5
20-2	D	1	1				
20-3	D	3				3	
20-4	D	4				4	
20-6	D	3					3
20-7	D/A	8					8
20-8	Inst.	6			2		4
20-9	D/A	8				1	7
20-11	Inst.	13					13
20-12	A	2		1			1
20-14	A	5			2	3	
20-15	A	7				7	
20-16	A	9				2	7
20-17	A	6				5	1
20-18	A	9				3	6
20-19	A	3			3		
20-20	A	4		1		3	
20-21	A	9				1	8
20-22	A	6			3		3
20-23	A	2			2		
20-24	A	4			2		2
20-25	Inst.	13					13
20-27	A	14					14
20-29	A	17					17
20-30	Inst.	13					13
20-33	A	11					11
20-51	A	3			3		
20-57	A	7				7*	
20-58	A	10				5	5
20-59	A	3			3*		
20-66	A	6				5*	1
20-79	D/A	8				1	7
22-1	D	2			2		
22-2	D	3			3		
22-4	A	4			2	2	
22-5	D	6				2	4
22-6	D	3			2		1
22-7	E	1	1				
22-8	E	2				2	
22-9	E	3				3	
22-10	E	4					4
22-11	B	2					2
22-12	D	5			2		3
22-13	D/A	5				4	1
22-14	A	19					19
22-15	E/A	6				5	1
22-16	A	9				3	6
22-17	D/A	9				1	8
22-18	D/A	8					8

* Crimp contacts accommodate wire the same size as the contact as well as wire of the next smaller, even size. Arrangements identified with an asterisk (*) are exceptions. See insert arrangement drawings on pages 11-32 for application wire size.

AC Series

insert availability, cont.

Insert Arrangement	Service Rating	Total Contacts	Contact Size																
			4/0	2/0	0	4	8	12	16	Coax**									
										0	4	8	12						
22-19	A	14										14							
22-20	A	9										9							
22-21	A	3			1							2							
22-22	A	4					4												
22-23	D/A	8									8								
22-24	D/A	6									2	4							
22-27	D/A	9						1				8							
22-28	A	7									7								
22-33	D/A	7										7							
22-34	D	5									3	2							
22-36	D/A	8									8								
22-63	A	12									4	8							
22-65	D/A	8									8*								
22-70	A	13									8	5							
22-80	A	3						3*											
24-2	D	7									7								
24-3	D	7									2	5							
24-5	A	16										16							
24-6	D/A	8									8								
24-7	A	16									2	14							
24-9	A	2				2													
24-10	A	7						7											
24-11	A	9						3	6										
24-12	A	5				2			3										
24-16	D/A	7						1	3	3									
24-17	D	5							2	3									
24-19	A	12										12							
24-20	D	11								2	9								
24-21	D	10						1			9								
24-22	D	4						4											
24-27	E	7									7								
24-28	Inst.	24										24							
24-51	A	5							5										
24-52	Hi-Volt	1								1									
24-53	A	5							5										
24-58	A	13							3	3	7								
24-59	A	14								7	7								
24-60	A	7							7*										
24-65	A	15									11	4							
24-66	D	7									7								
24-67	Inst.	19									19								
24-71	A	7							7*										
24-75	A	7							7*										
24-79	A	5							5										
24-80	Inst.	23										23							
24-84	A	19								1									18
24-96	Inst.	28										28							
24-AJ	A	25										25							
28-1	D/A	9							3	6									
28-2	D	14									2	12							

* Crimp contacts accommodate wire the same size as the contact as well as wire of the next smaller, even size. Arrangements identified with an asterisk (*) are exceptions. See insert arrangement drawings on pages 11-32 for application wire size.

Insert Arrangement	Service Rating	Total Contacts	Contact Size																
			4/0	2/0	0	4	8	12	16	Coax**									
										0	4	8	12						
28-3	E	3										3							
28-4	E/D	9											2	7					
28-5	D	5									2		1	2					
28-6	D	3									3								
28-7	D	2									2								
28-8	E/D/A	12											2	10					
28-9	D	12											6	6					
28-10	D/A	7									2	2	3						
28-11	A	22											4	18					
28-12	A	26												26					
28-13	A	26												26					
28-15	A	35												35					
28-16	A	20												20					
28-17	B/D/A	15												15					
28-18	C/D/A/Inst.	12												12					
28-19	B/D/A	10											4	6					
28-20	A	14											10	4					
28-21	A	37												37					
28-22	D	6									3			3					
28-51	A	12											12						
28-59	A	17											7	10					
28-66	A	16										2	14						
28-72	Coax	3															3		
28-74	A	16											7*	9					
28-75	A	16											7*	9					
28-79	A	16											7	9					
28-82	D	6										2	4						
28-84	A	9										9							
28-AY	A	9									4			5					
32-1	E/D	5								2			3						
32-2	E	5									3			2					
32-3	D	9								1	2		2	4					
32-4	A/D	14											2	12					
32-5	D	2								2									
32-6	A	23									2	3	2	16					
32-7	Inst./A	35											7	28					
32-8	A	30											6	24					
32-9	D	14									2			12					
32-10	E/B/D/A	7									2	2		3					
32-12	A/D	15											5	10					
32-13	D	23											5	18					
32-14	D	13											13						
32-15	D	8								2			6						
32-16	A	23									2	3	2	16					
32-17	D	4										4							
32-22	A	54												54					
32-25	A	25											25						
32-31	A	31												31					
32-48	Inst.	48												48					
32-52	D	8								2			6						
32-53	Inst./E	42											5	37					

**Coaxial cable data can be found on insert arrangement drawings, pages 11-32. For further information on coaxial contacts and cable see catalog 12-130.

AC Series

insert availability, cont.

Insert Arrangement	Service Rating	Total Contacts	Contact Size															
			4/0	2/0	0	4	8	12	16	Coax**								
										0	4	8	12					
32-56	A	30						6*	24									
32-57	Coax	8						6		2								
32-58	Coax	4									4							
32-59	A	42							40			2						
32-60	A	23							15			8						
32-62	Coax	23				2	1	2	16			2						
32-64	Inst.	54							54									
32-68	A	16							12		4							
32-73	A	46							46									
32-75	Coax	9							2			7						
32-76	A	19							19									
32-79	D	5				4	1											
32-82	A	16				4			12									
32-AF	A	55							55									
36-1	D	22							4	18								
36-3	D	6				3			3									
36-4	D/A	3				3												
36-5	A	4				4												
36-6	A	6				2	4											
36-7	A	47							7	40								
36-8	A	47							1	46								
36-9	A	31					1	2	14	14								
36-10	A	48								48								
36-11	A	48								48								
36-12	A	48								48								
36-13	E/A	17							2	15								
36-14	D	16						5	5	6								
36-15	D/A	35								35								
36-16	A	47							7	40								
36-17	A	47							7	40								
36-18	A	31					1	2	14	14								
36-20	A	34						2	2	30								
36-51	D	4				2	2											
36-52	A	52								52								
36-54	A	39						8		31								
36-55	A	39						8*		31								
36-59	A	53							3*	50								
36-60	A	47							7*	40								
36-64	Coax	4								4								
36-65	Coax	4								4								
36-71	A	53							3	50								
36-73	Coax	7									7							
36-74	A	44								43		1						
36-75	A	48								48*								
36-76	A	47								47								
36-77	D	7					7											
36-78	A	14						12		2								
36-79	A	20								20								
36-80	A	20								20*								

Insert Arrangement	Service Rating	Total Contacts	Contact Size															
			4/0	2/0	0	4	8	12	16	Coax**								
										0	4	8	12					
36-83	Coax	7															7	
36-85	A/D	35												35*				
36-97	C	1	1															
36-99	D	12							3	3	3	3						
36-AF	A	48												48				
40-1	D	30										6	24					
40-5	A	5							5									
40-9	A	47								1	22	24						
40-10	A	29							4	9	16							
40-30	A	30							1		29							
40-35	D	35									35							
40-53	A	60										60						
40-56	A	85										85						
40-57	E	4							4									
40-61	A	59								1	3	55						
40-62	A	60										60						
40-63	A	61										61*						
40-64	Coax	36									3	20				13		
40-66	Coax	4											4					
40-67	A	11										1				10		
40-68	A	21								21								
40-70	A	61										61						
40-72	A	11										1				10		
40-73	A	61										61						
40-74	A	6									1		4	1				
40-75	E	5							4		1							
40-80	A	11								10		1						
40-81	A	62										62*						
40-82	A	62										62						
40-85	A	60										60						
40-86	E	4											4					
40-87	D	7								7								
40-AD	A	8							4		4							
40-AG	A	38										38						
40-AP	E	2	2															
40-AR	Inst.	13							3	3		7						
40-AS	A	40										25	15					
40-AT	A	43									1	24	18					
40-AU	A	14								3	10		1					
40-AV	D	3							3									

**Coaxial cable data can be found on insert arrangement drawings, pages 11-32. For further information on coaxial contacts and cable see catalog 12-130.

* Crimp contacts accommodate wire the same size as the contact as well as wire of the next smaller, even size. Arrangements identified with an asterisk (*) are exceptions. See insert arrangement drawings on pages 11-32 for application wire size.

AC Series

insert alternate positioning

To avoid cross-plugging problems in applications requiring the use of more than one connector of the same size and arrangement, alternate rotations are available as indicated in the accompanying charts.

As shown in the diagram below, the front face of the pin insert is rotated within the shell in a clockwise direction from the normal shell key. The socket insert would be rotated counter-clockwise the same number of degrees in respect to the normal shell key.

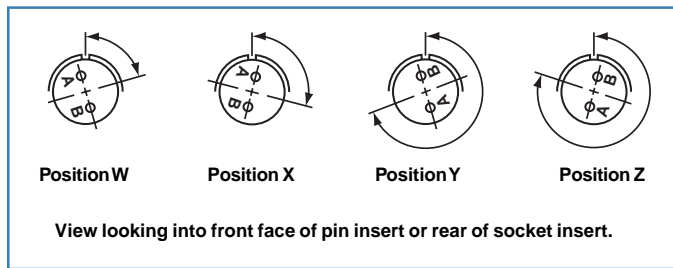

The following insert arrangements have the same alternate insert rotations for W, X, Y and Z, which are:

Degrees			
W	X	Y	Z
80	110	250	280

16-7	20-20	22-21	24-7	28-8	32-1	36-1
18-5	20-22	22-24	24-12	28-9	32-3	36-7
18-9	22-3	22-25	24-14	28-10	32-4	36-8
18-13	22-6	22-29	24-16	28-11	32-6	36-13
18-14	22-12	22-33	24-17	28-14	32-9	40-AR
20-7	22-14	22-34	24-20	28-15	32-10	40-AS
20-8	22-15	24-1	24-21	28-16	32-12	40-AT
20-9	22-16	24-3	24-28	28-17	32-13	40-AU
20-12	22-17	24-4	24-AJ	28-19	32-22	
20-14	22-18	24-5	28-1	28-20	32-31	
20-16	22-19	24-6	28-4	28-21	32-AF	

Insert Arrangement	Degrees			
	W	X	Y	Z
10-SL-4	63	-	-	-
12S-3	70	145	215	290
14S-2	-	120	240	-
14S-5	-	110	-	-
14S-7	90	180	270	-
14S-9	70	145	215	290
16-9	35	110	250	325
16-10	90	180	270	-
16-11	35	110	250	325
16-13	35	110	250	325
16S-1	80	-	-	280
16S-4	35	110	250	325
16S-5	70	145	215	290
16S-6	90	180	270	-
16S-8	-	170	265	-
18-1	70	145	215	290
18-3	35	110	250	325
18-4	35	110	250	325
18-8	70	-	-	290
18-10	-	120	240	-
18-11	-	170	265	-
18-12	80	-	-	280
18-15	-	120	240	-
18-20	90	180	270	-
18-22	70	145	215	290
18-29	90	180	270	-
20-3	70	145	215	290
20-4	45	110	250	-
20-5	35	110	250	325
20-6	70	145	215	290
20-15	80	-	-	280
20-17	90	180	270	-
20-18	35	110	250	325

Insert Arrangement	Degrees			
	W	X	Y	Z
20-19	90	180	270	-
20-21	35	110	250	325
20-23	35	110	250	325
20-24	35	110	250	325
20-27	35	110	250	325
20-29	80	-	-	280
22-1	35	110	250	325
22-2	70	145	215	290
22-4	35	110	250	325
22-5	35	110	250	325
22-8	35	110	250	325
22-9	70	145	215	290
22-10	35	110	250	325
22-11	35	110	250	325
22-13	35	110	250	325
22-20	35	110	250	325
22-22	-	110	250	-
22-23	35	-	250	-
22-27	80	-	250	280
22-28	80	-	-	280
22-63	20	-	-	-
24-2	80	-	-	280
24-9	35	110	250	325
24-10	80	-	-	280
24-11	35	110	250	325
24-22	45	110	250	-
24-27	80	-	-	280
28-2	35	110	250	325
28-3	70	145	215	290
28-5	35	110	250	325
28-6	70	145	215	290
28-7	35	110	250	325
28-12	90	180	270	-

Insert Arrangement	Degrees			
	W	X	Y	Z
28-18	70	145	215	290
28-22	70	145	215	290
28-AY	45	110	250	-
32-2	70	145	215	290
32-5	35	110	250	325
32-7	80	125	235	280
32-8	80	125	235	280
32-14	65	130	230	295
32-15	35	110	250	280
32-17	45	110	250	-
32-25	60	120	-	-
32-48	80	-	-	-
32-64	80	100	110	250
32-68	30	-	-	-
32-82	30	-	-	-
36-3	70	145	215	290
36-4	70	145	215	290
36-5	-	120	240	-
36-6	35	110	250	325
36-9	80	125	235	280
36-10	80	125	235	280
36-14	90	180	270	-
36-15	60	125	245	305
36-AF	65	-	-	-
40-1	65	130	235	300
40-5	33	-	-	270
40-9	65	125	225	310
40-10	65	125	225	310
40-35	70	130	230	290
40-AD	45	-	-	-
40-AG	37	74	285	322
40-AP	35	110	250	325
40-AV	90	180	270	-

AC Series contact arrangements

front face of pin insert or rear face of socket insert illustrated

	Front of Socket Insert	Front of Socket Insert					
Insert Arrangement	10SL-3	10SL-4	12S-3	12S-4	12-5	14S-1	14S-2
Service Rating	A	A	A	D	D	A	Inst.
Number of Contacts	3	2	2	1	1	3	4
Contact Size	16	16	16	16	12	16	16
						100° Rotation of 14S-2	
Insert Arrangement	14S-4	14S-5	14S-6	14S-7	14S-9	14S-10	
Service Rating	D	Inst.	Inst.	A	A	Inst.	
Number of Contacts	1	5	6	3	2	4	
Contact Size	16	16	16	16	16	16	
	100° Rotation of 14S-7						
Insert Arrangement	14S-12	14S-A7	14-3	16S-1	16S-3	16S-4	
Service Rating	A	A	A	A	B	D	
Number of Contacts	3	7	1	7	1	2	
Contact Size	16	16	8	16	16	16	
Insert Arrangement	16S-5	16S-6	16S-8	16-2	16-7	16-9	
Service Rating	A	A	A	E	A	A	
Number of Contacts	3	3	5	1	1 2	2 2	
Contact Size	16	16	16	12	8 16	12 16	
					16	12	8
					4	0	
					CONTACT LEGEND		

AC Series contact arrangements

front face of pin insert or rear face of socket insert illustrated

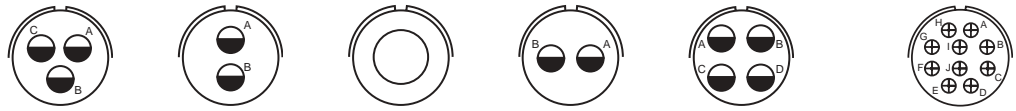

Insert Arrangement	16-10	16-11	16-12	16-13	16-59	18-1
Service Rating	A	A	A	A	A	B, C, F, G = A; bal. = Inst.
Number of Contacts	3	2	1	2*	4	10
Contact Size	12	12	4	12	12	16

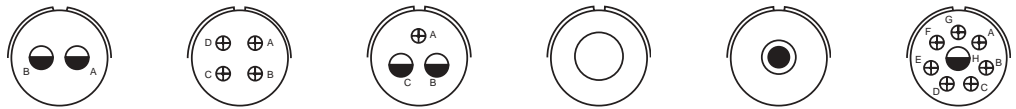

Insert Arrangement	18-3	18-4	18-5	18-6	18-7	18-8
Service Rating	D	D	D	D	B	A
Number of Contacts	2	4	2 1	1	1	1 7
Contact Size	12	16	12 16	4	8	12 16



Insert Arrangement	18-9	18-10	18-11	18-12	18-13	18-14
Service Rating	Inst.	A	A	A	A	A
Number of Contacts	2 5	4	5	6	1 3	1 1
Contact Size	12 16	12	12	16	8 12	4 16

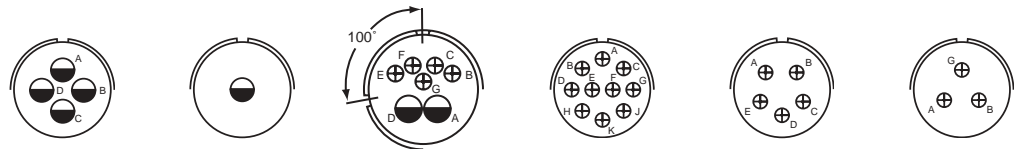

Insert Arrangement	18-15	18-16	18-17	18-19	18-20	18-22
Service Rating	A	C	Inst.	A	A	D
Number of Contacts	4**	1	2 5	10	5	3
Contact Size	12	12	12 16	16	16	16



CONTACT LEGEND 16 12 8 4 0

*A = Iron; B = Constantan

**A, C = Iron; B, D = Constantan

AC Series contact arrangements

front face of pin insert or rear face of socket insert illustrated

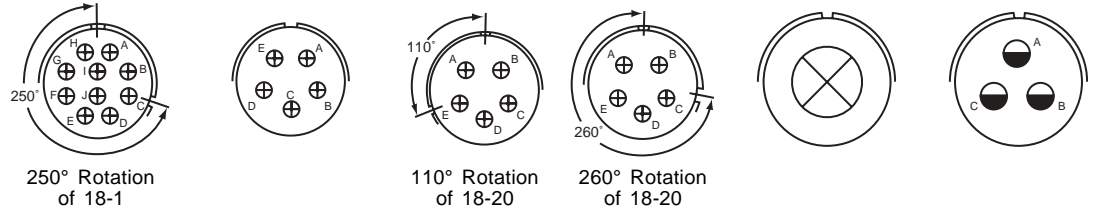

Insert Arrangement	18-24	18-29	18-30	18-31	20-2	20-3
Service Rating	B, C, F, G = A; Bal. = Inst.	A	A	A	D	D
Number of Contacts	10	5	5	5	1	3
Contact Size	16	16	16	16	0	12



Insert Arrangement	20-4	20-6	20-7	20-8	20-9	20-11
Service Rating	D	D	A, B, H, G = D; C, D, E, F = A	Inst.	H = D; Bal. = A	Inst.
Number of Contacts	4	3	8	2 4	1 7	13
Contact Size	12	16	16	8 16	12 16	16

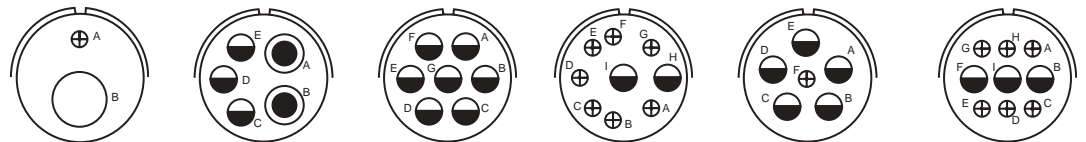

Insert Arrangement	20-12	20-14	20-15	20-16	20-17	20-18
Service Rating	A	A	A	A	A	A
Number of Contacts	1 1	2 3	7	2 7	5 1	3 6
Contact Size	4 16	8 12	12	12 16	12 16	12 16

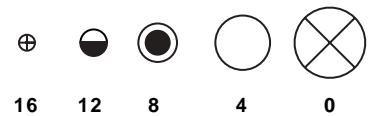

AC Series contact arrangements

front face of pin insert or rear face of socket insert illustrated

Insert Arrangement	20-19	20-20	20-21	20-22	20-23	20-24
Service Rating	A	A	A	A	A	A
Number of Contacts	3	1 3	1 8	3 3	2	2 2
Contact Size	8	4 12	12 16	8 16	8	8 16
	100° Rotation of 20-11			250° Rotation of 20-11		
Insert Arrangement	20-25	20-27	20-29	20-30	20-33	20-51
Service Rating	Inst.	A	A	Inst.	A	A
Number of Contacts	13	14	17	13	11	3*
Contact Size	16	16	16	16	16	8
Insert Arrangement	20-57	20-58	20-59	20-66	20-79	
Service Rating	A	A	A	A	H = D; Bal. = A	
Number of Contacts	7*	5 5	3*	1 5	7* 1*	
Contact Size	12 for #14 or 16 wire	12 16	8 for #10 or 12 wire	16 12 for #10 wire	16 12 for #16 wire	

* Solderless

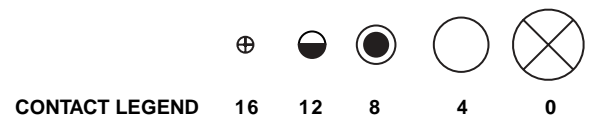

AC Series contact arrangements

front face of pin insert or rear face of socket insert illustrated

Insert Arrangement	22-1	22-2	22-4	22-5	22-6	22-7
Service Rating	D	D	A	D	D	E
Number of Contacts	2	3	2 2	2 4	2 1	1
Contact Size	8	8	8 12	12 16	8 16	0
Insert Arrangement	22-8	22-9	22-10	22-11	22-12	22-13
Service Rating	E	E	E	B	D	E = D; A, B, C, D = A
Number of Contacts	2	3	4	2	2 3	4 1
Contact Size	12	12	16	16	8 16	12 16
Insert Arrangement	22-14	22-15	22-16	22-17	22-18	
Service Rating	A	D = E; A, B, C, E, F = A	A	A = D; Bal. = A	A, B, F, G, H = D; C, D, E = A	
Number of Contacts	19	5 1	3 6	1 8	8	
Contact Size	16	12 16	12 16	12 16	16	

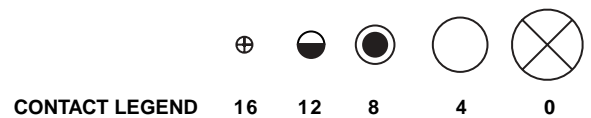

AC Series

contact arrangements

front face of pin insert or rear face of socket insert illustrated

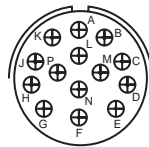

22-19

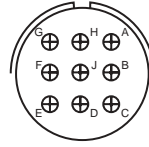

22-20

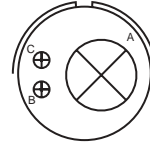

22-21

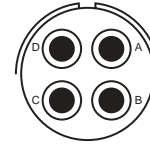

22-22

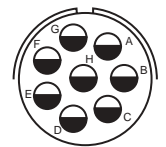

22-23

Insert Arrangement
Service Rating
Number of Contacts
Contact Size

A
14
16

A
9
16

A
1 2
0 16

A
4
8

H = D; Bal = A
8
12

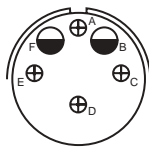

22-24

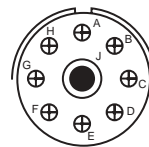

22-27

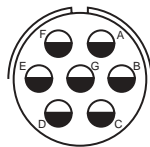

22-28

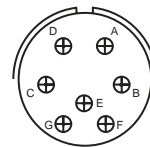

22-33

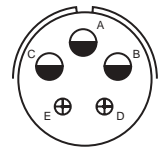

22-34

Insert Arrangement
Service Rating
Number of Contacts
Contact Size

C, D, E = D; A, B, F = A
2 4
12 16

J = D; Bal. = A
1 8
8 16

A
7
12

A, B, C, D = D; E, F, G = A
7
16

D
3 2
12 16

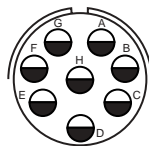

22-36

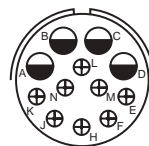

22-63

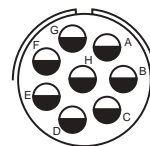

22-65

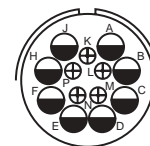

22-70

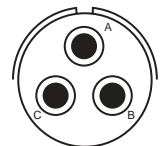

22-80

Insert Arrangement
Service Rating
Number of Contacts
Contact Size

H = D; Bal. = A**
8
12

A
4 8
12 16

H = D; Bal. = A
8*
12 for #14 or 16 wire

A
8 5
12 16

A
3*
8 for #10 or 12 wire

* Solderless

** A, C, E, G = Iron

B, D, F, H = Constantan



CONTACT LEGEND

16 12 8 4 0

AC Series contact arrangements

front face of pin insert or rear face of socket insert illustrated

Insert Arrangement	24-2	24-3	24-5	24-6	24-7
Service Rating	D	D	A	A, G, H = D; Bal. = A	A
Number of Contacts	7	2 5	16	8	2 14
Contact Size	12	12 16	16	12	12 16

Insert Arrangement	24-9	24-10	24-11	24-12	24-16
Service Rating	A	A	A	A	A, B, F, G = D; C, D, E = A
Number of Contacts	2	7	3 6	2 3	1 3 3
Contact Size	4	8	8 12	4 12	8 12 16

Insert Arrangement	24-17	24-19	24-20	24-21	24-22
Service Rating	D	A	D	D	D
Number of Contacts	2 3	12	2 9	1 9	4
Contact Size	12 16	16	12 16	8 16	8

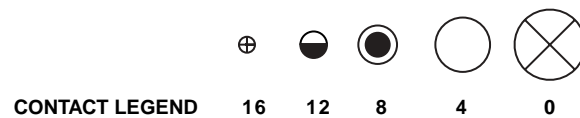

AC Series contact arrangements

front face of pin insert or rear face of socket insert illustrated

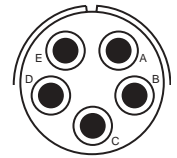
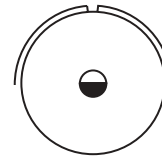
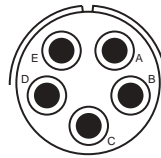
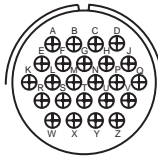
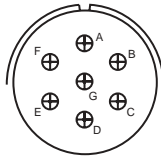

Insert Arrangement
Service Rating
Number of Contacts
Contact Size

24-27
E
7
16

24-28
Inst.
24
16

24-51
A
5*
B, E for AN#10 or 12 wire
A, C, D for AN #8 wire

24-52
Hi-Volt
1
12

24-53
A
5*
8

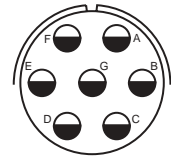
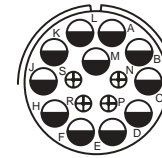
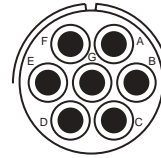
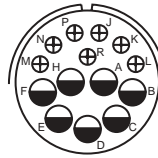
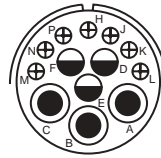

Insert Arrangement
Service Rating
Number of Contacts
Contact Size

24-58
A
3 3 7
8 12 16

24-59
A
7 7
12 16

24-60
A
7*
8 for #10 or 12 wire

24-65
A
11 4
12 16

24-66
D
7
12

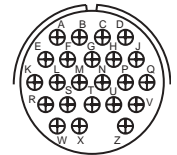
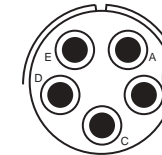
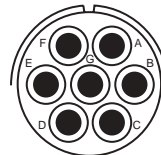
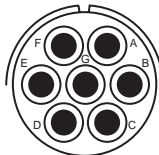
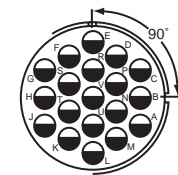

Insert Arrangement
Service Rating
Number of Contacts
Contact Size

24-67
Inst.
19
12

24-71
A
2* 5*
8 8 for #10 or 12 wire

24-75
A
5 2
8 8 for #16 wire

24-79
A
5
8

24-80
Inst.
23
16

* Solderless

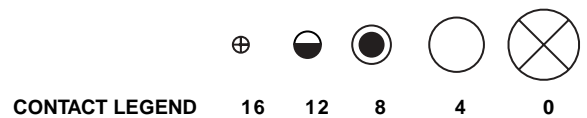

AC Series contact arrangements

front face of pin insert or rear face of socket insert illustrated

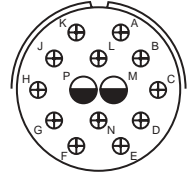
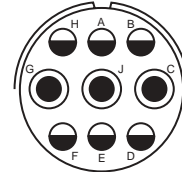
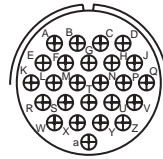
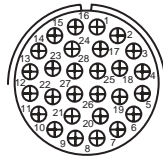
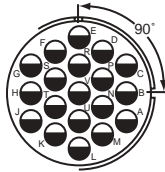

Insert Arrangement	24-84	24-96	24-AJ	28-1	28-2
Service Rating	A	Inst.	A	A, J, E = D; Bal. = A	D
Number of Contacts	1 18	28	25	3 6	2 12
Contact Size	12 12 (Coax) RG-188/U or RG-174/U	16	16	8 12	12 16

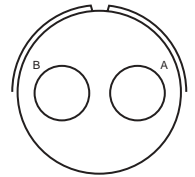
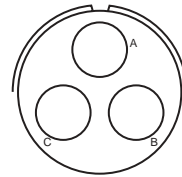
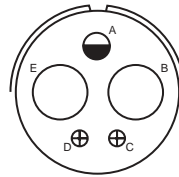
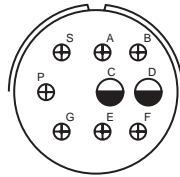
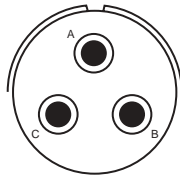

Insert Arrangement	28-3	28-4	28-5	28-6	28-7
Service Rating	E	G, P, S = E; Bal. = D	D	D	D
Number of Contacts	3	2 7	2 1 2	3	2
Contact Size	8	12 16	4 12 16	4	4

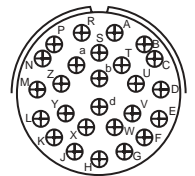
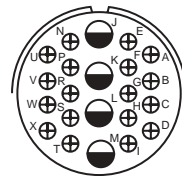
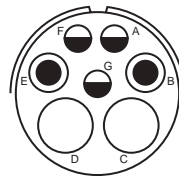
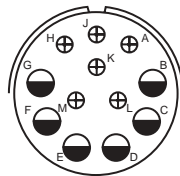
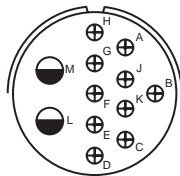

Insert Arrangement	28-8	28-9	28-10	28-11	28-12
Service Rating	L, M = E; B = D; Bal. = A	D	G = D; Bal. = A	A	A
Number of Contacts	2 10	6 6	2 2 3	4 18	26
Contact Size	12 16	12 16	4 8 12	12 16	16



CONTACT LEGEND 16 12 8 4 0

AC Series contact arrangements

front face of pin insert or rear face of socket insert illustrated

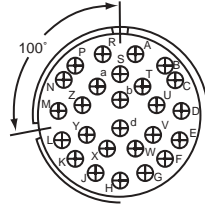

100° Rotation
of 28-12

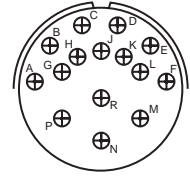
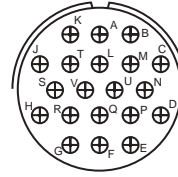
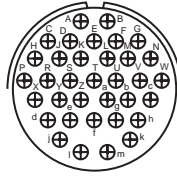

Insert Arrangement	28-13	28-15	28-16	28-17
Service Rating	A	A	A	R = B; M, N, P = D; A to L = A
Number of Contacts	26	35	20	15
Contact Size	16	16	16	16

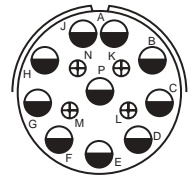
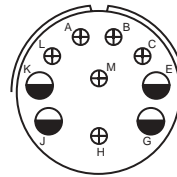
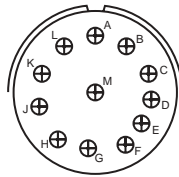

Insert Arrangement	28-18	28-19	28-20
Service Rating	M = C; G, H, J, K, L = D; A, B = A; Bal = Inst.	H, M = B; A, B = D; Bal = A	A
Number of Contacts	12	4 6	10 4
Contact Size	16	12 16	12 16

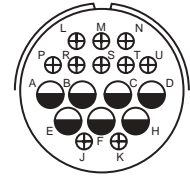
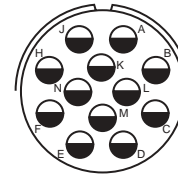
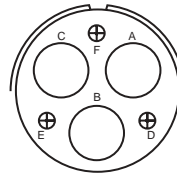
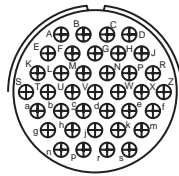

Insert Arrangement	28-21	28-22	28-51	28-59
Service Rating	A	D	A	A
Number of Contacts	37	3 3	12	7 10
Contact Size	16	4 16	12	12 16



CONTACT LEGEND 16 12 8 4 0

AC Series contact arrangements

front face of pin insert or rear face of socket insert illustrated

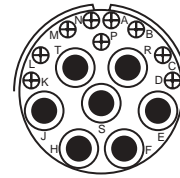
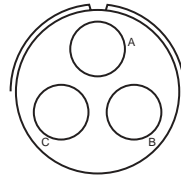
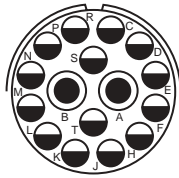

Insert Arrangement	28-66	28-72	28-74	28-75
Service Rating	A	-	A	A
Number of Contacts	2 14	3	9* 4* 3*	9* 7*
Contact Size	8 12	4 (Coax) RG-59 A/U	16 8 8 for #10 wire	16 8 for #10 wire

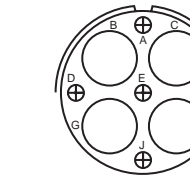
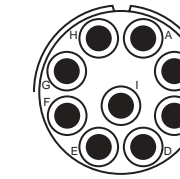
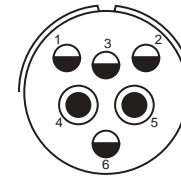
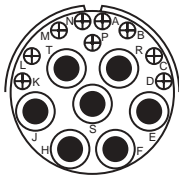

Insert Arrangement	28-79	28-82	28-84	28-AY
Service Rating	A	D	A	A
Number of Contacts	9 7	2 4	9	4 5
Contact Size	16 8	8 12	8	4 16

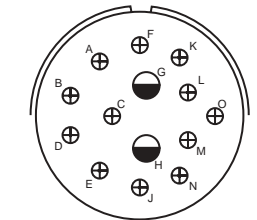
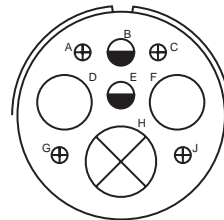
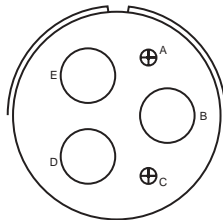
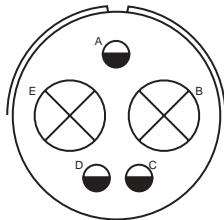

Insert Arrangement	32-1	32-2	32-3	32-4
Service Rating	A = E; B, C, D, E = D	E	D	F, J, K, N = A; Bal. = D
Number of Contacts	2 3	3 2	1 2 2 4	2 12
Contact Size	0 12	4 16	0 4 12 16	12 16

* Solderless

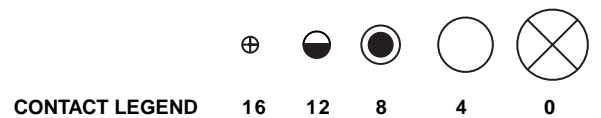

AC Series

contact arrangements

front face of pin insert or rear face of socket insert illustrated

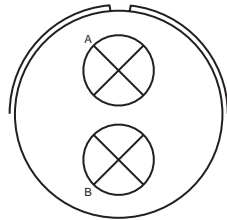

32-5
D
2
0

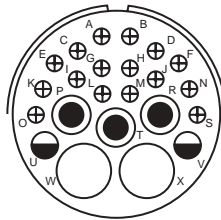

32-6
A
2 3 2 16
4 8 12 16

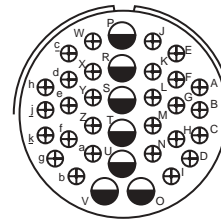

32-7
A, B, h, j = Inst.; Bal = A
7 28
12 16

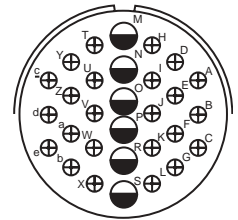

32-8
A
6 24
12 16

Insert Arrangement
Service Rating
Number of Contacts
Contact Size

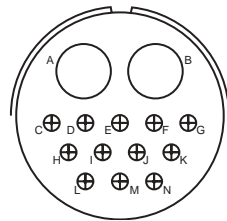

32-9
D
2 12
4 16

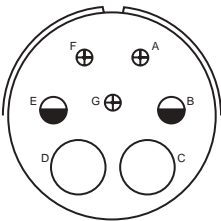

32-10
A, F = E; G = B; B, E = D; C, D = A
2 2 3
4 8 16

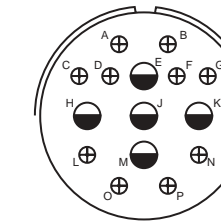

32-12
C, D, E, F, G = A; Bal. = D
5 10
12 16

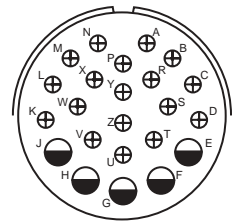

32-13
D
5 18
12 16

Insert Arrangement
Service Rating
Number of Contacts
Contact Size

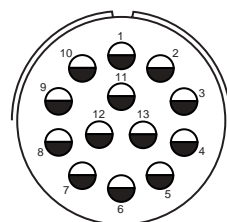

32-14
D
13
12

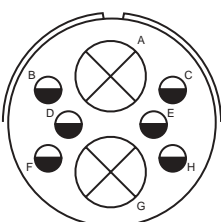

32-15
D
2 6
0 12

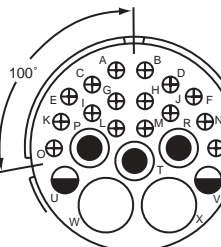

100° Rotation
of 32-6

32-16
A
2 3 2 16
4 8 12 16

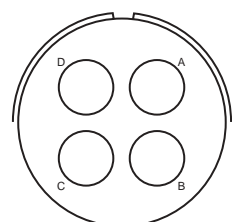

32-17
D
4
4

Insert Arrangement
Service Rating
Number of Contacts
Contact Size



CONTACT LEGEND 16 12 8 4 0

AC Series contact arrangements

front face of pin insert or rear face of socket insert illustrated

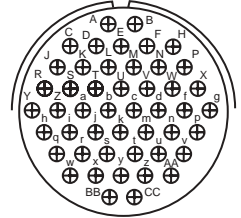
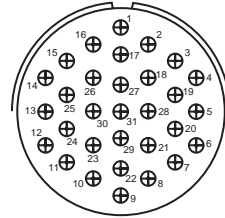
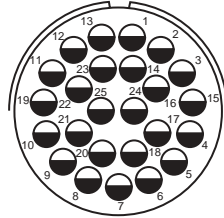
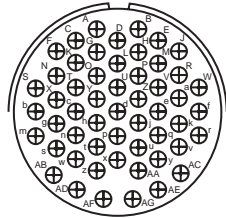

Insert Arrangement
Service Rating
Number of Contacts
Contact Size

32-22
A
54
16

32-25
A
25
12

32-31
A
31
16

32-48
Inst.
48
16

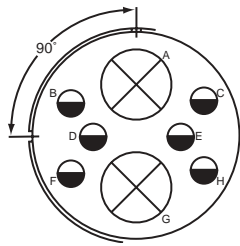

100° Rotation
of 28-12

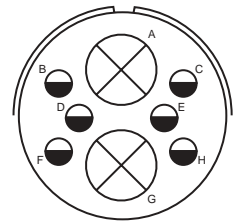
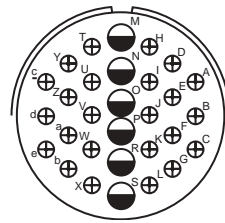
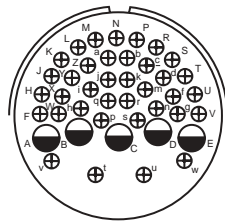

Insert Arrangement
Service Rating
Number of Contacts
Contact Size

32-52
D
2 6
0 12

32-53
t, u = E; Bal = Inst.
5 37
12 16

32-56
A
24 6
16 12 for #10 wire

32-57

6 2
12 0 (Coax) RG-71/U

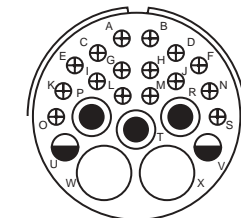
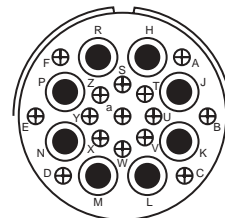
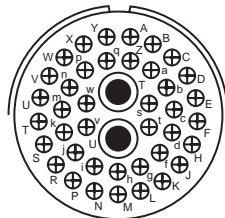
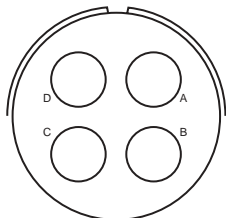

Insert Arrangement
Service Rating
Number of Contacts
Contact Size

32-58
-
4
**4 (Coax) RG-161/U
or RG-179/U**

32-59
A
40 2
16 8 (Coax) RG-161/U

32-60
A
15 8
**16 8 (Coax)
RG-124/U**

32-62

2 1 2 16 2
**4 8 12 16 8 (Coax)
RG-124/U16**



CONTACT LEGEND 16 12 8 4 0

** Consult Sidney, NY for service rating of power contacts.

AC Series contact arrangements

front face of pin insert or rear face of socket insert illustrated

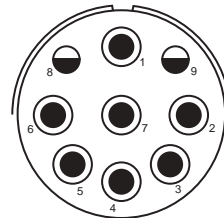
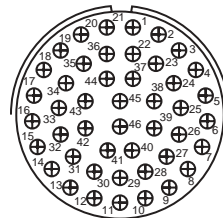
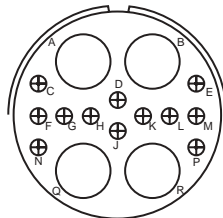
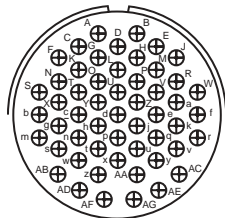

Insert Arrangement	32-64	32-68	32-73	32-75
Service Rating	Inst.	A	A	8, 9 = D
Number of Contacts	54	12 4	46	2 7
Contact Size	16	16 4 (Coax) RG-58 C/U	16	12 8 (Coax) RG-180 B/U

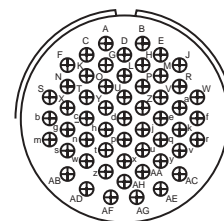
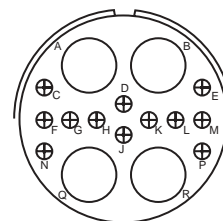
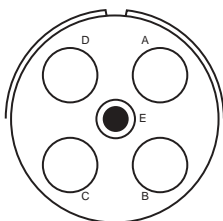
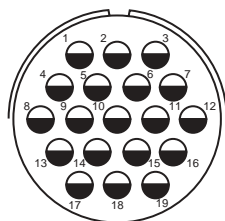

Insert Arrangement	32-76	32-79	32-82	32-8F
Service Rating	A	D	A	A
Number of Contacts	19	4 1	12 4	55
Contact Size	12	4 8	16 4	16

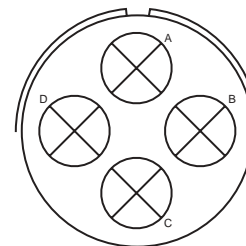
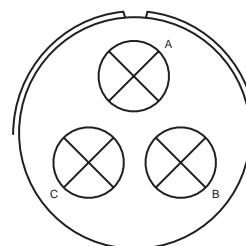
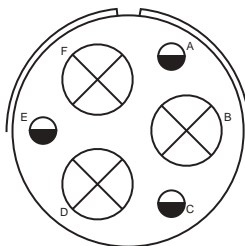
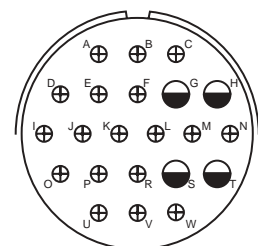

Insert Arrangement	36-1	36-3	36-4	36-5
Service Rating	D	D	A = D; B, C = A	A
Number of Contacts	4 18	3 3	3	4
Contact Size	12 16	0 12	0	0

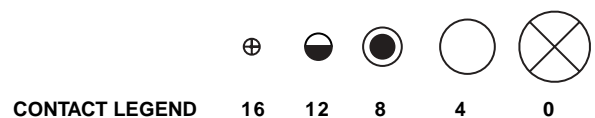

AC Series contact arrangements

front face of pin insert or rear face of socket insert illustrated

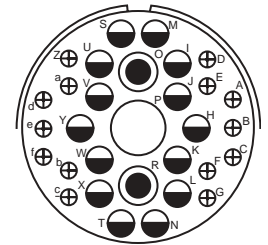
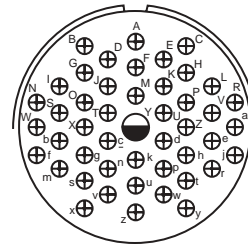
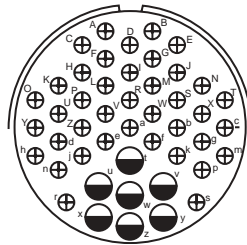
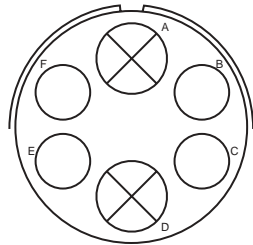

Insert Arrangement	36-6	36-7	36-8	36-9
Service Rating	A	A	A	A
Number of Contacts	2 4	7 40	1 46	1 2 14 14
Contact Size	0 4	12 16	12 16	4 8 12 16

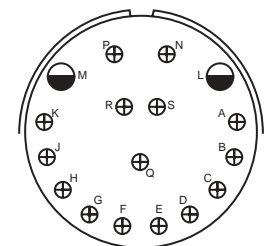
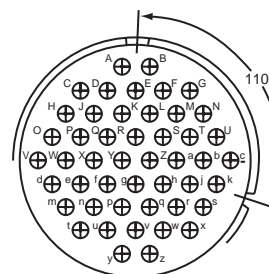
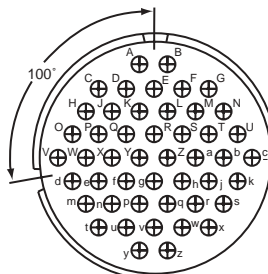
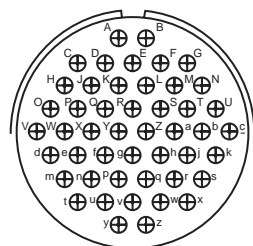

Insert Arrangement	36-10	36-11	36-12	36-13
Service Rating	A	A	A	N, P, Q = E; Bal. = A
Number of Contacts	48	48	48	2 15
Contact Size	16	16	16	12 16

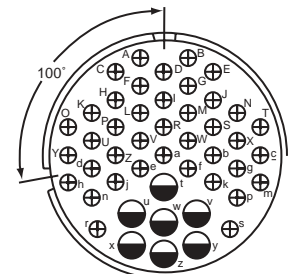
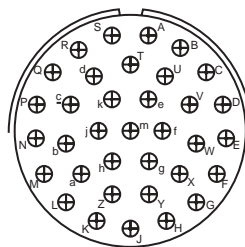
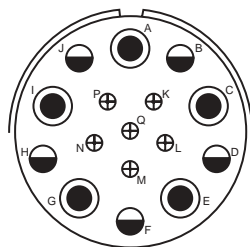

Insert Arrangement	36-14	36-15	36-16
Service Rating	D	M = D; Bal. = A	A
Number of Contacts	5 5 6	35	7 40
Contact Size	8 12 16	16	12 16



CONTACT LEGEND 16 12 8 4 0

AC Series contact arrangements

front face of pin insert or rear face of socket insert illustrated

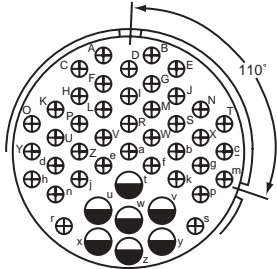

110° Rotation
of 36-7

Insert Arrangement
Service Rating
Number of Contacts
Contact Size

36-17
A
7 40
12 16

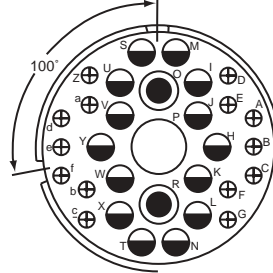

100° Rotation
of 36-9

36-18
A
1 2 14 14
4 8 12 16

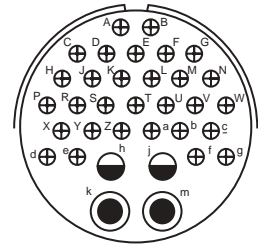

36-20

A
2 2 30
8 12 16

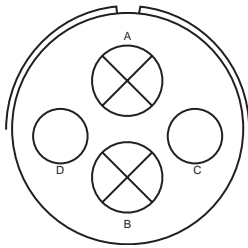

36-51

Insert Arrangement
Service Rating
Number of Contacts
Contact Size

D
2 2
0 4

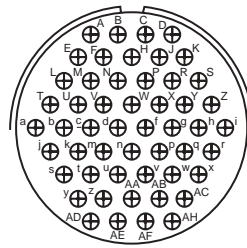

36-52

A
52
16

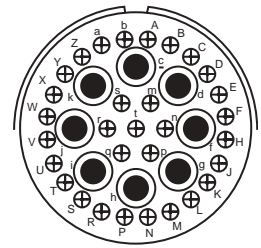

36-54

A
8 31
8 16

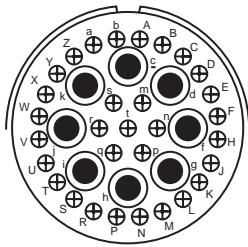

36-55

Insert Arrangement
Service Rating
Number of Contacts
Contact Size

A
31 8
16 8 for #6 wire

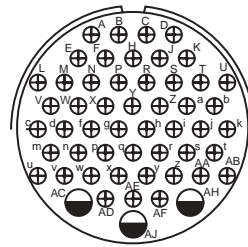

36-59

A
50 3
16 12 for #10 wire

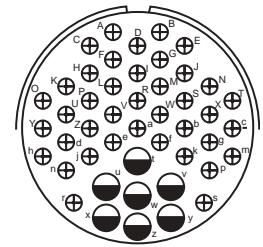

36-60

40 7
16 12 for #10 wire



CONTACT LEGEND

16 12 8 4 0

** Consult Sidney, NY for service rating of power contacts.

AC Series contact arrangements

front face of pin insert or rear face of socket insert illustrated

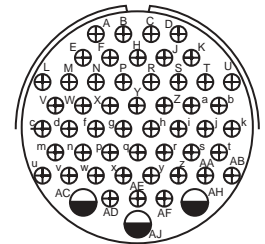
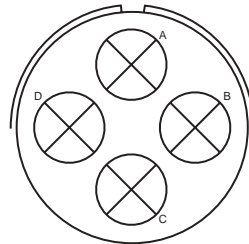
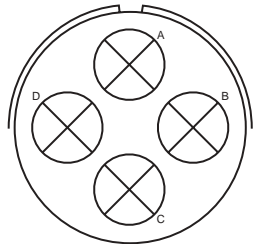

Insert Arrangement 36-64
Service Rating -
Number of Contacts 4
Contact Size 0 (Coax) RG-11/U,
 RG-12/U or RG-13/U

Insert Arrangement 36-65
Service Rating -
Number of Contacts 4
Contact Size 0 (Coax) RG-59/U, RG-62/U
 or RG-71/U

Insert Arrangement 36-71
Service Rating A
Number of Contacts 3 50
 12 16

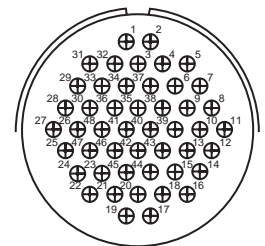
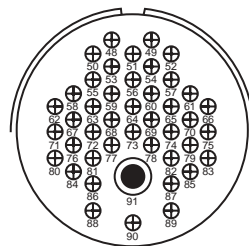
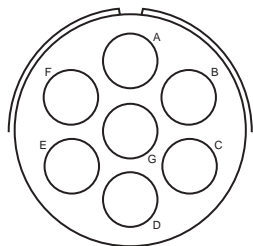

Insert Arrangement 36-73
Service Rating -
Number of Contacts 7
Contact Size 4 (Coax) RG-62B/U

Insert Arrangement 36-74
Service Rating A
Number of Contacts 43 1
 16 8 (Coax) RG-187/U

Insert Arrangement 36-75
Service Rating A
Number of Contacts 48
 16 for #14 wire

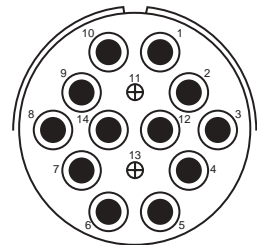
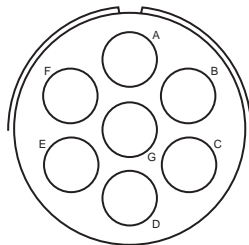
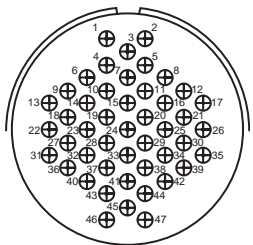

Insert Arrangement 36-76
Service Rating A
Number of Contacts 47
Contact Size 16

Insert Arrangement 36-77
Service Rating D
Number of Contacts 7
 4

Insert Arrangement 36-78
Service Rating A
Number of Contacts 2 12
 16 8



** Consult Sidney, NY for service rating of power contacts.

CONTACT LEGEND

16 12 8 4 0

AC Series

contact arrangements

front face of pin insert or rear face of socket insert illustrated

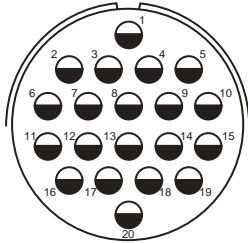

36-79

Insert Arrangement
Service Rating
Number of Contacts
Contact Size

A
20
12

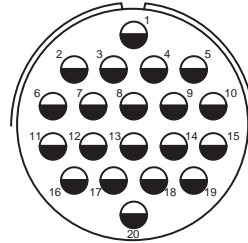

36-80

A
20
12 for #10 wire

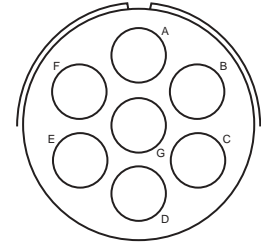

36-83

-
7
4 (Coax) RG-58/U

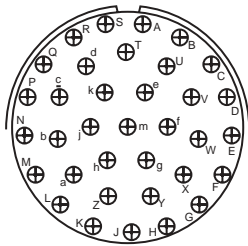

36-85

Insert Arrangement
Service Rating
Number of Contacts
Contact Size

M = D; Bal. = A
35
16 for #12 wire

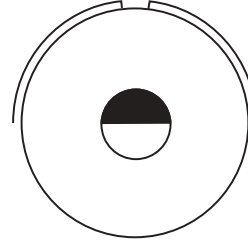

36-97

C
1
4/0

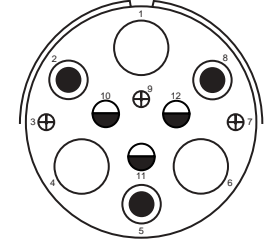

36-99

D
3 3 3 3
4 8 12 16

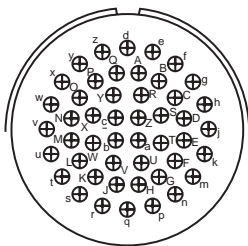

36-AF

Insert Arrangement
Service Rating
Number of Contacts
Contact Size

A
48
16

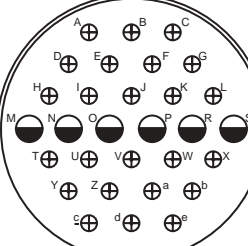

40-1

D
6 24
12 16

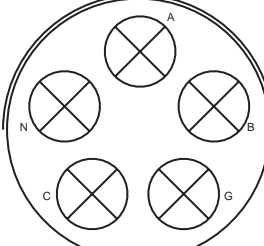

40-5

A
5
0

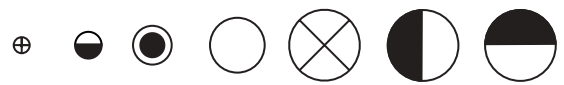

CONTACT LEGEND 16 12 8 4 0 2/0 4/0

AC Series contact arrangements

front face of pin insert or rear face of socket insert illustrated

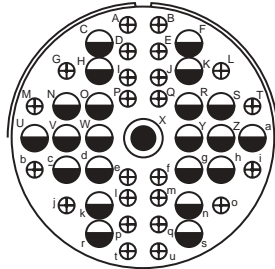

Insert Arrangement 40-9
Service Rating A
Number of Contacts 1 22 24
Contact Size 8 12 16

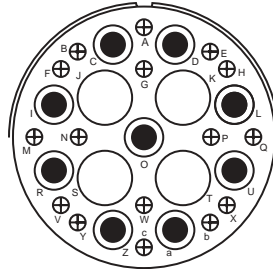

Insert Arrangement 40-10
Service Rating A
Number of Contacts 4 9 16
Contact Size 4 8 16

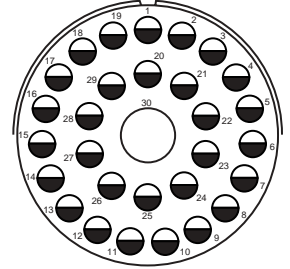

Insert Arrangement 40-30
Service Rating A
Number of Contacts 29 1
Contact Size 12 4

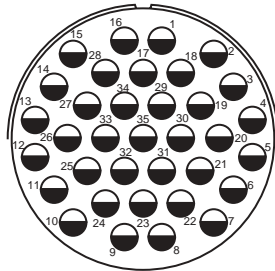

Insert Arrangement 40-35
Service Rating D
Number of Contacts 35
Contact Size 12

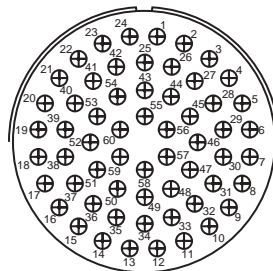

Insert Arrangement 40-53
Service Rating A
Number of Contacts 60
Contact Size 16

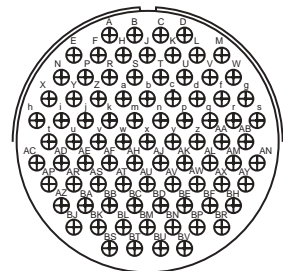

Insert Arrangement 40-56
Service Rating A
Number of Contacts 85
Contact Size 16

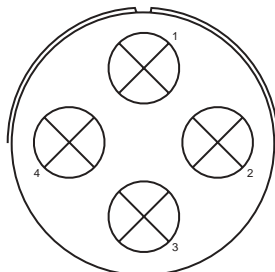

Insert Arrangement 40-57
Service Rating E
Number of Contacts 4
Contact Size 0

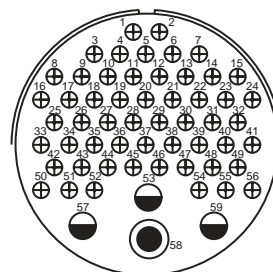

Insert Arrangement 40-61
Service Rating A
Number of Contacts 1 3 55
Contact Size 8 12 16

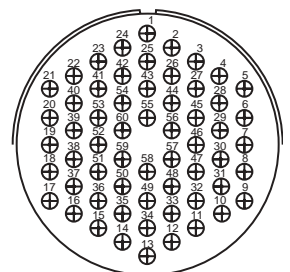

Insert Arrangement 40-62
Service Rating A
Number of Contacts 60
Contact Size 16



CONTACT LEGEND 16 12 8 4 0

AC Series contact arrangements

front face of pin insert or rear face of socket insert illustrated

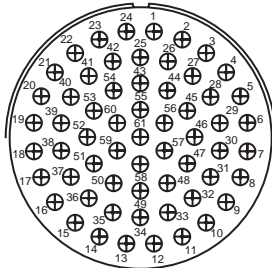

40-63

Insert Arrangement
Service Rating
Number of Contacts
Contact Size

A
61
16 for #14 wire

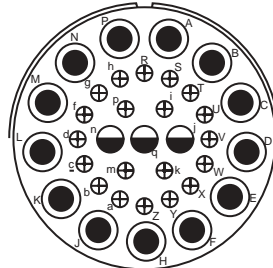

40-64

3 20 13
12 16 8 (Coax) RG-124/U

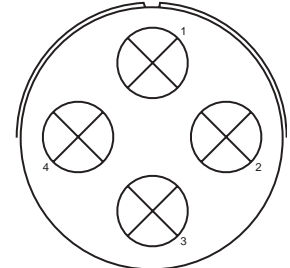

40-66

4
0 (Coax) RG-63B/U

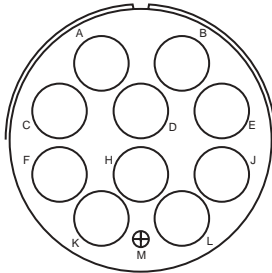

40-67

Insert Arrangement
Service Rating
Number of Contacts
Contact Size

A
1 10
16 4 (Coax) RG-59/U

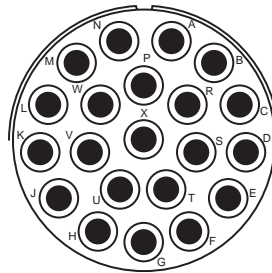

40-68

A
21
8

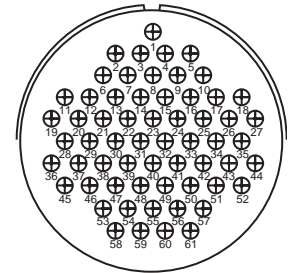

40-70

A
61
16

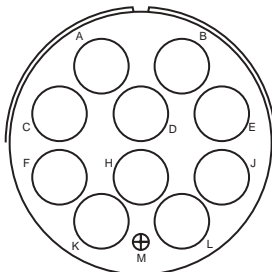

40-72

Insert Arrangement
Service Rating
Number of Contacts
Contact Size

A
1 10
16 4 (Coax) RG-9B/U

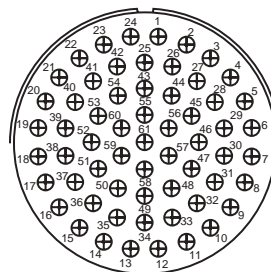

40-73

A
61
16

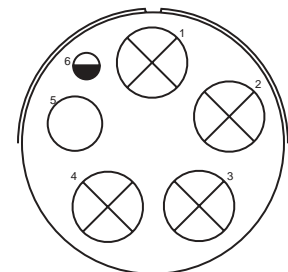

40-74

A
1 1 4
12 4 (Coax) RG-62/U 0 (Coax) RG-9B/U or RG-214/U



CONTACT LEGEND 16 12 8 4 0

AC Series contact arrangements

front face of pin insert or rear face of socket insert illustrated

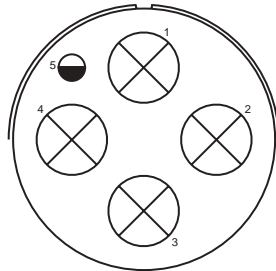

Insert Arrangement 40-75
Service Rating E
Number of Contacts 1 4
Contact Size 12 0

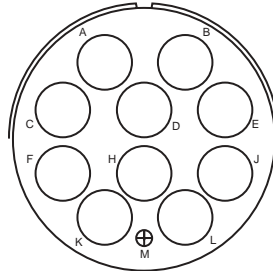

Insert Arrangement 40-80
Service Rating A
Number of Contacts 1 10
Contact Size 16 4

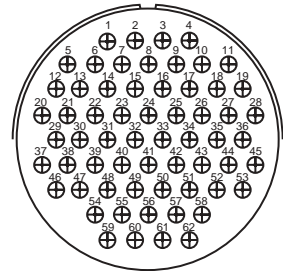

Insert Arrangement 40-81
Service Rating A
Number of Contacts 62
Contact Size 16 for #14 wire

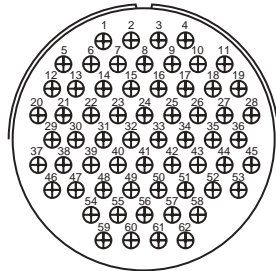

Insert Arrangement 40-82
Service Rating A
Number of Contacts 62
Contact Size 16

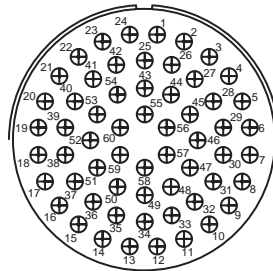

Insert Arrangement 40-85
Service Rating A
Number of Contacts 60
Contact Size 16 for #14 wire

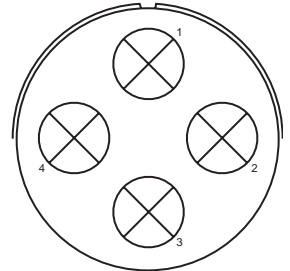

Insert Arrangement 40-86
Service Rating -
Number of Contacts 4
Contact Size 0 (Coax) RG-115A/U

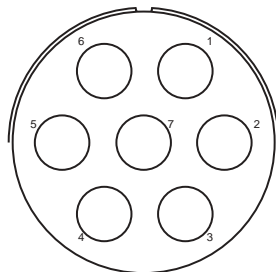

Insert Arrangement 40-87
Service Rating D
Number of Contacts 7
Contact Size 4

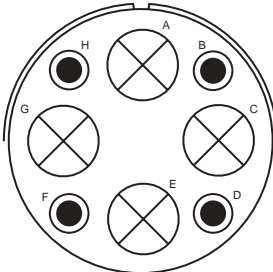

Insert Arrangement 40-AD
Service Rating A
Number of Contacts 4 4
Contact Size 8 0

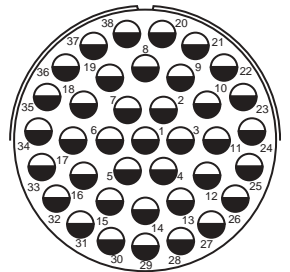

Insert Arrangement 40-AG
Service Rating A
Number of Contacts 38
Contact Size 12



CONTACT LEGEND 16 12 8 4 0

AC Series

contact arrangements

front face of pin insert or rear face of socket insert illustrated

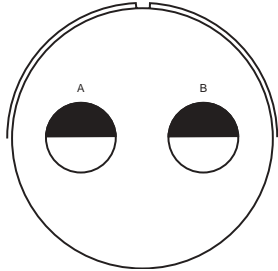

Insert Arrangement	40-AP
Service Rating	E
Number of Contacts	2
Contact Size	4/0

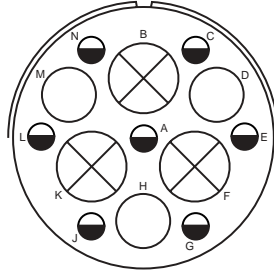

40-AR
Inst.
7 3 3
12 4 0

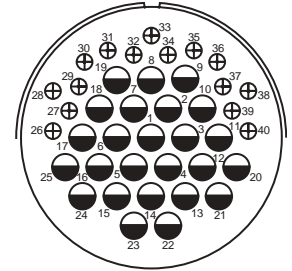

40-AS
A
15 25
16 12

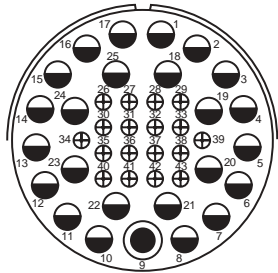

40-AT
A
24 18 1
12 16 8

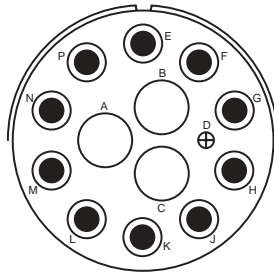

40-AU
A
3 10 1
4 8 16

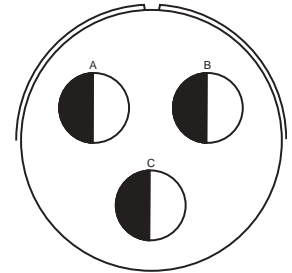

40-AV
D
3
2/0

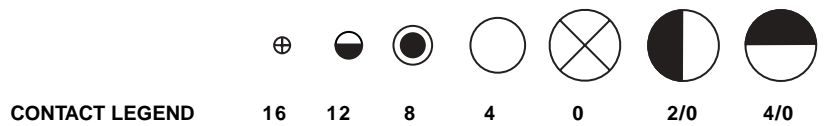

AC – accessories

10-40450, 10-36675 sealing gaskets, 10-405996 sealing plugs, sealing ranges

SEALING GASKETS

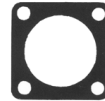
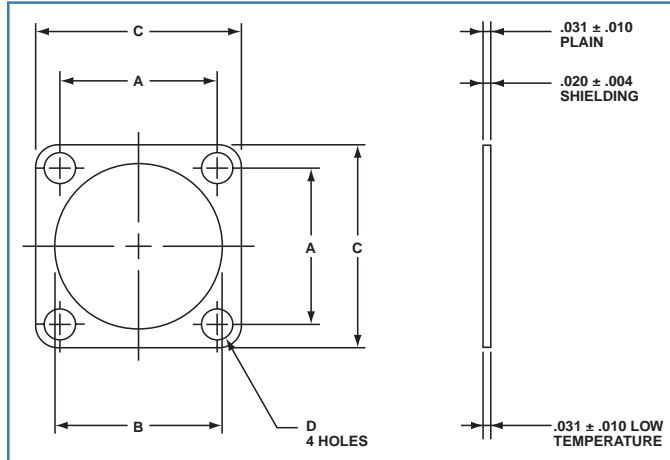

The Amphenol plain flat gasket of synthetic rubber material is provided to take complete advantage of waterproof and pressure sealing features. It is for use with the flange mounted receptacle.

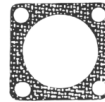

This flat gasket is provided to give the maximum in connector performance. Its special feature is in providing the maximum radio shielding under difficult conditions of high receiver sensitivity and low signal strength while retaining the sealing characteristics of the plain gasket. This gasket is for use with the flange mounting receptacle.

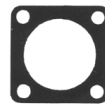

This gasket is provided for applications where the major requirement is resistance to the injurious effects of extremely low temperature. Even at temperatures as low as -67°F this gasket retains its resiliency and will seal a pressure differential of 30 psi.

MS Shell Size	Installation Dimensions								Order Data		
	Inches				Millimeters				Plain	Shielding	Low Temperature Style
	A $\pm .010$	B $+ .016$ $- .000$	C $+ .016$ $- .000$	D $\pm .010$	A $\pm .25$	B $+ .41$ $- .00$	C $+ .41$ $- .00$	D $\pm .25$			
8S	.594	.500	.875	.172	15.09	12.70	22.22	4.37	10-40450-8	10-40450-8S	10-36675-8
10S	.719	.625	1.000	.172	18.26	15.88	25.40	4.37	10-40450-10	10-40450-10S	10-36675-10
10SL	.719	.625	1.000	.172	18.26	15.88	25.40	4.37	10-40450-10	10-40450-10S	10-36675-10
12S	.813	.750	1.094	.172	20.65	19.05	27.79	4.37	10-40450-12	10-40450-12S	10-36675-12
12	.813	.750	1.094	.172	20.65	19.05	27.79	4.37	10-40450-12	10-40450-12S	10-36675-12
14S	.906	.875	1.188	.172	23.01	22.22	30.18	4.37	10-40450-14	10-40450-14S	10-36675-14
14	.906	.875	1.188	.172	23.01	22.22	30.18	4.37	10-40450-14	10-40450-14S	10-36675-14
16S	.969	1.000	1.281	.172	24.61	25.40	32.54	4.37	10-40450-16	10-40450-16S	10-36675-16
16	.969	1.000	1.281	.172	24.61	25.40	32.54	4.37	10-40450-16	10-40450-16S	10-36675-16
18	1.063	1.125	1.375	.203	27.00	28.57	34.92	5.16	10-40450-18	10-40450-18S	10-36675-18
20	1.156	1.250	1.500	.203	29.36	31.75	38.10	5.16	10-40450-20	10-40450-20S	10-36675-20
22	1.250	1.375	1.625	.203	31.75	34.92	41.27	5.16	10-40450-22	10-40450-22S	10-36675-22
24	1.375	1.500	1.750	.203	34.92	38.10	44.45	5.16	10-40450-24	10-40450-24S	10-36675-24
28	1.563	1.750	2.000	.203	39.70	44.45	50.80	5.16	10-40450-28	10-40450-28S	10-36675-28
32	1.750	2.000	2.250	.219	44.45	50.80	57.15	5.56	10-40450-32	10-40450-32S	10-36675-32
36	1.938	2.188	2.500	.219	49.23	55.58	63.50	5.56	10-40450-36	10-40450-36S	10-36675-36
40	2.188	2.438	2.750	.219	55.58	61.93	69.85	5.56	10-40450-40	10-40450-40S	10-36675-40

SEALING PLUG 10-405996-XX1

Sealing plugs are used to fill unused holes in multi-holed grommet configurations.

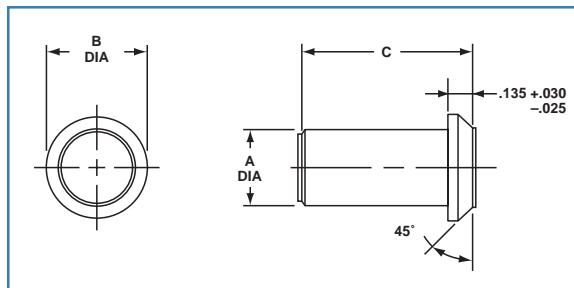

All dimensions for reference only.

Order No.	Contact Size	Wire Size	Color Code	Inches			Millimeters		
				A Dia $\pm .010$	B $\pm .005$	C $\pm .010$	A Dia. ± 0.2	B ± 0.1	C ± 0.2
10-405996-161	16	20-16	Blue	.083	.133	.564**	2.1	3.4	14.3***
10-405996-121	12	14-12	Yellow	.121	.171	.564**	3.1	4.3	14.3***
10-405996-081	8	10-8	White	.185	.315	.470	4.7	8.0	11.9
10-405996-041	4	4-6	Blue	.310	.415	.470	7.9	10.5	11.9
10-405996-001	0	0-2	Yellow	.440	.605	1.000	11.2	15.4	25.4

GROMMET HOLE SEALING RANGE

Hole Size	Sealing Range	
	Millimeters	Inches
16	2.3 – 3.0	.090 – .118
12	3.2 – 4.5	.126 – .177
8	3.8 – 6.5	.150 – .256
4	7.1 – 9.3	.279 – .366
0	10.0 – 13.7	.394 – .539

** $\pm .020$
*** ± 0.5 mm

AC Series solder contacts

Machined copper alloy contacts in a full range of sizes, with closed entry socket design in the size 12 and 16 contacts. A heavy silver-plated finish is deposited on all solder contacts for maximum corrosion resistance, maximum current carrying capacity and low millivolt drop.

SOLDER CONTACTS*

Part Number	Pin/Socket	Mating End Size	Wire Barrel Size	Allowable Wire Size	Test Current** Amps
10-40569	Pin	16 Short†	16	16	13
10-597107-161 or 10-597424-001	Socket			18	10
				20	7.5
10-40599	Pin	16 Long	16	22	5
10-597107-171 or 10-597422-001	Socket			16	13
				18	10
				20	7.5
10-33646	Pin	12	12	22	5
10-597107-131	Socket			12	23
10-35531	Pin	8	8	14	17
10-35532	Socket			8	46
10-35529	Pin	4	4	10	33
10-35530	Socket			4	80
10-35527	Pin			6	60
10-35528	Socket	0	0	0	150
				1	125
				2	100

* Solder Wells Filled

** Contact ratings as stated are test ratings only. The connector may not withstand full rated current through all contacts continuously. Please note that the electrical data given is not an establishment of electrical safety factors. This is left entirely in the designer's hands as he can best determine which peak voltage, switching surges, transients, etc. can be expected in a particular circuit.

† The 10SL, 12S, 14S and 16S connectors require short contacts.

**Table I
CONTACT ARRANGEMENT
SERVICE RATING**

MS Service Rating	Recommended Operating Voltage* at Sea Level		Effective Creepage Distance Nom.	Mechanical Spacing Nom.
	D C	AC (RMS)		
Inst.	250	200	1/16	
A	700	500	1/8	1/16
D	1250	900	3/16	1/8
E	1750	1250	1/4	3/16
B	2450	1750	5/16	1/4
C	4200	3000	1	5/16

* The values listed in Table I represent operating values which include a generous safety factor. It may be necessary for some applications to exceed the operating voltages listed here. If this is necessary, designers will find Table II useful for determining the degree to which the recommended values of Table I can be exceeded.

**Table II
ALTITUDE VOLTAGE
DERATING** CHART**

MS Service Rating	Nominal Distance		Standard Sea Level Conditions		Pressure Altitude † 50,000 Feet		Pressure Altitude † 70,000 Feet	
	Airspace	Creepage	Minimum Flashover Voltage	Test Voltage	Minimum Flashover Voltage	Test Voltage	Minimum Flashover Voltage	Test Voltage
			AC (RMS)	AC (RMS)	AC (RMS)	AC (RMS)	AC (RMS)	AC (RMS)
Inst.	1/32	1/16	1400	1000	550	400	325	260
A	1/16	1/8	2800	2000	800	600	450	360
D	1/8	3/16	3600	2800	900	675	500	400
E	3/16	1/4	4500	3500	1000	750	550	440
B	1/4	5/16	5700	4500	1100	825	600	480
C	5/16	1	8500	7000	1300	975	700	560

† Not corrected for changes in density due to variations in temperature

** No attempt has been made to recommend operating voltages. The designer must determine his own operating voltage by the application of a safety factor to the above derating chart to compensate for circuit transients, surges, etc.

AC Series

crimp contacts

Machined from copper alloys and silver-plated for maximum corrosion resistance, with a minimum millivolt drop and a maximum current carrying capacity, the size 16 and 12 socket contacts are of the closed entry design. Crimp contacts are available for all insert arrangements and are identified with a Amphenol® proprietary number. Gold plated contacts are also available. (See how to order on page 37).

CRIMP CONTACTS*

Part Number	Pin/Socket	Mating End Size	Wire Barrel Size	Allowable Wire Size	Required Wire Adapter Sleeve	Test Current** Amps
10-40553	Pin	16 Short†	16	16	–	13
10-597109-161	Socket			18	–	10
				20	–	7.5
				22*	10-74696-6	5
10-40557	Pin	16 Long	16	16	–	13
10-597109-171	Socket			18	–	10
				20	–	7.5
				22*	10-74696-6	5
10-40561	Pin	12	12	12	–	23
10-597109-131	Socket			14	–	17
10-40792	Pin	8	8	8	–	46
10-40793	Socket			10*	10-74696-1	33
10-40564	Pin	4	4	4	–	80
10-40565	Socket			6*	10-74696-2	60
10-581806-000	Pin	0	0	0	–	150
10-581808-000	Socket			2*	10-74696-7	125

* When using wire adapter sleeve shown

** Contact ratings as stated are test ratings only. The connector may not withstand full rated current through all contacts continuously. Please note that the electrical data given is not an establishment of electrical safety factors. This is left entirely in the designer's hands as he can best determine which peak voltage, switching surges, transients, etc. can be expected in a particular circuit.

† The 10SL, 12S, 14S and 16S connectors require short contacts.

Additional contact variations are available; consult Amphenol, Sidney NY for information.

Table I
CONTACT ARRANGEMENT
SERVICE RATING

MS Service Rating	Recommended Operating Voltage* at Sea Level		Effective Creepage Distance Nom.	Mechanical Spacing Nom.
	DC	AC (RMS)		
Inst.	250	200	1/16	
A	700	500	1/8	1/16
D	1250	900	3/16	1/8
E	1750	1250	1/4	3/16
B	2450	1750	5/16	1/4
C	4200	3000	1	5/16

Table II
ALTITUDE VOLTAGE
DERATING CHART**

MS Service Rating	Nominal Distance		Standard Sea Level Conditions		Pressure Altitude † 50,000 Feet		Pressure Altitude † 70,000 Feet	
	Airspace	Creepage	Minimum Flashover Voltage	Test Voltage	Minimum Flashover Voltage	Test Voltage	Minimum Flashover Voltage	Test Voltage
			AC (RMS)	AC (RMS)	AC (RMS)	AC (RMS)	AC (RMS)	AC (RMS)
Inst.	1/32	1/16	1400	1000	550	400	325	260
A	1/16	1/8	2800	2000	800	600	450	360
D	1/8	3/16	3600	2800	900	675	500	400
E	3/16	1/4	4500	3500	1000	750	550	440
B	1/4	5/16	5700	4500	1100	825	600	480
C	5/16	1	8500	7000	1300	975	700	560

† Not corrected for changes in density due to variations in temperature.

** No attempt has been made to recommend operating voltages. The designer must determine his own operating voltage by the application of a safety factor to the above derating chart to compensate for circuit transients, surges, etc.

AC Series

application tools, torque values

When proprietary crimp contacts are employed rather than the standard MS approved solder contacts, the following application tools are recommended for use. There is a possibility of additional crimping tools other than those included being available at present or in the future for this specific application.

Complete instructions for providing reliable crimped wire to contact terminations and inserting proprietary crimp contacts in AC Series connectors are available in publication L-757.

TOOLING CHART

Crimping Tool	Positioner/Turret	Contact Size	Contact Style	Insertion Tool	Removal Tool
M22520/1-01	*	16	Pin & Socket	11-7345	11-8250 Kit
M22520/1-01	*	12	Pin & Socket	11-7082	11-8250 Kit
**	**	8	Pin & Socket	11-8220	11-8250 Kit
**	**	4	Pin & Socket	11-7365-4 †	Pin 11-7370-4 † Socket 11-7674-2 †
**	**	0	Pin & Socket	11-7365-5 †	Pin 11-7370-5 † Socket 11-7674-3 †

* Use Daniels Turret TH29-1 or Astro Tool Co. Turret 616266

** For appropriate crimp tool and positioner refer to Pico Crimping Tool Co.

† Tools used with Arbor Press 11-7364

RECOMMENDED TORQUE FORCES CONNECTOR BACKSHELLS

Size	In./Lb. Max.	Size	In./Lb. Max.
10SL	26	22	85
14S	44	24	90
16	50	28	114
16S	50	32	120
18	55	36	153
20	65	40	170

AC Series

how to order

To more easily illustrate ordering procedure, part number ACCL06AF18-1SX(025) is shown as follows:

<u>AC</u>	<u>C</u>	<u>L</u>	<u>06</u>	<u>AF</u>	<u>18-1</u>	<u>S</u>	<u>X</u>	<u>(025)</u>
1	2	3	4	5	6	7	8	9

1. AC designates Amphenol Industrial Series Threaded Connectors
2. C designates Crimp Contacts
S designates Solder Contacts
3. L designates low smoke zero halogen inserts and grommets
Omit for standard resilient inserts and grommets.
4. Shell Style
00 - Wall Mounting Receptacle
01 - Line Receptacle
02 - Box Mounting Receptacle
05 - Straight Plug
06 - Straight Plug with hardware
08 - 90 degree Plug
5. Class
A or AF - General duty connector
E or F - Environmental connector for a wire bundle
PGA or
PGR - Environmental connector for jacketed cable
6. Shell size and insert arrangement
See insert availability on pages 7-9
7. Contact type
P - Pin contacts
S - Socket contacts
R - RADSOK® socket contacts* (see page 39)

Ask for Brochure SL-391 for Amphe-Power Connectors with RADSOK Technology.
8. Alternate insert rotation
“W”, “X”, “Y”, “Z” designates that the insert is rotated in its shell from a normal position. No letter required for normal (no rotation) position.
See page 10 for availability.
9. Variations RoHS Compliant
(003) - Olive drab cadmium plate finish
(023) - Electroless nickel finish
(025) - Black zinc alloy finish
(G96) - Black hard-coat anodize
(A24) - .000035 gold/nickel on contacts
(116) - Non-pre-tinned solder contacts
(472) - Black zinc alloy finish and solder contacts
less pre-filled cup ✓
(548) - Electroless nickel finish and solder contacts
less pre-filled cup ✓



For further RoHS Compliant support, contact Amphenol Industrial Operations or call 1-866-315-8559.

Additional Products

reverse bayonet coupling MIL-5015 type connectors

Amphenol has replaced the previously available AC-B series with the ACA-B.

The ACA-B is a modification of the MIL-5015 family designed for commercial and industrial environments requiring a rugged bayonet style connector, including heavy duty power and signal applications. A comprehensive selection of insert arrangements and accessory hardware are available to accommodate heavy-duty, commercial wire and cable. The rugged shell is made from aluminum alloy and plated with a variety of finishes to meet any application.

Features of the ACA-B Reverse Bayonet series:

- Quick positive coupling with audible and tactile indication of full coupling.
- Intermateable with existing VG95234 connectors
- Rated 500 couplings minimum.
- No lockwiring required
- Inserts available in Neoprene material with alternate materials available upon request.
- Contacts available in gold and silver plating
- Available in both crimp and solder terminations
- Numerous finishes available, including cadmium free zinc alloy.
- Rugged construction; aluminum or stainless steel components.

Ask for Amphenol catalog 12-027 for further information on ACA-B Reverse Bayonet Connectors.



Amphenol ACA-B Reverse Bayonet Connectors

GT Reverse Bayonet Connectors

Amphenol GT Series of Connectors are heavy duty, rugged and environmentally resistant, and are the preferred interconnect for the mass transit industry. They are also used in power generation, petrochemical industries and heavy equipment/geophysical marketplaces. GT connector utilize MIL-5015 inserts and are intermateable with existing VG95234 connectors. Other features include:

- reverse bayonet coupling - quick mating, audible, visual and tactile full mating indicators.
- UL recognized
- rated to 2000 couplings min.
- operating temperature range:
 - with Neoprene inserts: -55°C to $+125^{\circ}\text{C}$
 - with Viton** inserts: -50°C to $+200^{\circ}\text{C}$
 - with low smoke/flame retardant inserts: -55°C to $+125^{\circ}\text{C}$
- available in both crimp and solder termination
- rugged construction - aluminum or stainless steel components
- numerous military and commercial finishes available including zinc alloy (cadmium free)
- resilient inserts provide high dielectric strength and moisture barrier. IP67 performance in environmental versions
- over 40 varieties of shell styles and backend accessory combinations, including the following specials:
 - GT-PC with first mate/last break
 - GTC-M for high voltage power applications
- resilient cover coupling nuts available for added damage protection and increased gripping surface



Amphenol® GT Reverse Bayonet Connectors

Ask for Amphenol catalog 12-024 for further information on GT Series Connectors.

Amphenol Power GT Connectors are also available that incorporate RADSOK socket contacts. See page 39 for advantages and features of RADSOK contacts for high amperage capability.

AC Threaded Connectors with RADSOK® Contacts

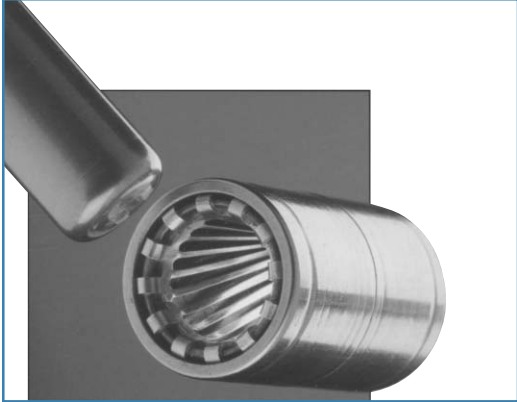

RADSOK Contact Design:

- Socket cylinder within female contact has several equally spaced longitudinal beams twisted into a hyperbolic shape.
- As male pin is inserted, axial members in the female half deflect, imparting high current flow across the connection with minimal voltage loss.
- The hyperbolic, stamped grid configuration ensures a large, coaxial, face-to-face surface area engagement.
- Ideal for crimp termination applications requiring repeated mating cycles and high current with a low milli-volt drop.

AMPHE-POWER™ Connectors with RADSOK® Contacts
For the most demanding industrial and transportation applications.



AC Threaded Connector with RADSOK® High Amperage Contacts

The new RADSOK contact design has been incorporated into three of the time-tested and reliable families of Amphenol Industrial Connectors, all of which are MIL-5015 styles. These series include the AC Threaded 5015, the P-Lok Series, and the GT Series. (Not available in AC Bayonet types currently).

Amphe-Power connectors with RADSOK sockets can handle up to 150% higher amperages than connectors with standard contacts. Current Amphe-Power product lines support from 50A to 500A continuous duty. RADSOK contacts are available in size 8 (69 amps), size 4 (120 amps), and size 0 (250 amps).

RADSOK Contact Advantages:

- Low contact resistance - the RADSOK contact's multiplicity of flat grid surfaces assures the greatest possible contact area on the mating pin. This results in longer life - reduced contact pressure yields reduced wear.
- Low milli-volt drop performance - due to the intimate contact provided by the spring force of the grid, the flat contact surface and the wiping action during insertion.
- Higher current capacity with minimized temperature rise. Lower overall contact resistance reduces heat build-up, thereby allowing higher current capacities at given temperature limits. Connectors with RADSOK contacts may be produced in various sizes with a variety of amperage capabilities.
- Reliability under vibration and shock. System inertia is minimized by the small package and the fact that the contact is under a spring load.
- High quality, consistency and lower cost with high speed, automated precision stamping and assembly technology

Amphe-Power AC 5015 Connectors can be ordered with the same part numbering configuration as shown on page 37, except use the letter R for contact type. See Brochure SL-391, Amphenol Amphe-Power Connectors with RADSOK Technology for RADSOK layouts that are currently tooled and for further information.

Additional Products

other MIL-5015 type connectors from Amphenol

MS/Standard MIL-5015 Type Connectors

Amphenol has long been the accepted leader in providing MS/Standard MIL-5015 type connectors. When a Mil-Spec 5015 connector is required, these connectors provide well-proven electrical capability. They are tested to strict adherence to military specifications, and they are offered in a very broad range of product styles and options. Features include:

- medium to heavy weight cylindrical with resilient inserts
- environmental resistant
- threaded couplings, single key/keyway shell polarization
- operating voltage to 3000 VAC (RMS) at sea level
- 5 shell styles, 19 shell sizes, 280 contact arrangements
- solder or crimp contacts (non-rear-release type), sizes 16–0 accepting 22–0 AWG
- coaxial or thermocouple contact options
- alternate insert positioning
- hermetic configurations available
- zinc alloy plating (cadmium-free) available

Within the MS/Standard family there are five mil-spec classes to meet different requirements:

- A – Solid Shell – for general, non-environmental applications.
- C – Pressurized – for use on pressurized bulkheads or pressure barriers; limits air leakage regardless of type and class of plug mated with them.
- E/F – Environmental Resisting with Strain Relief – designed for applications where the connector will be exposed to moisture, vibration, and rapid changes in pressure and temperature.
- R – Lightweight Environmental Resisting – shorter in length, lighter in weight than the E & F classes, the MS-R offers a high degree of reliability under adverse conditions: recommended for new design applications.

Ask for Amphenol catalog 12-020 which gives detailed information on this family of connectors.

MIL-5015 Modifications

In order to supplement standard MS shell styles and provide a greater variety of styles for the electrical connector user, there are several MS and MS Modified cylindrical connectors offered by Amphenol.

These types include flange mount plugs, thru bulkhead receptacles, jam nut receptacles, connectors for potting and connectors designed specifically to terminate jacketed cable.

Ask for Amphenol catalog 12-021 for detailed information.

97 Series, MIL-5015 Type Connectors

The low cost, general duty connector used extensively in the machine tool industry, welding industry and numerous other industrial applications, is the Amphenol 97 Series. Offered in non-environmental styles, these connectors have hard dielectric inserts and threaded coupling. They are Underwriters Laboratories Recognized and Canadian Standards Association Certified.

Ask for Amphenol catalog 12-022 for detailed information.



Amphenol® MS/Standard MIL-5015 Connectors



Amphenol® 97 Series Connectors

Additional Products

other MIL-5015 type connectors from Amphenol

Amphenol® Pre-Earth FMLB Connectors

Amphenol Pre-Earth/First Mate Last Break Connectors are designed for applications where a protective circuit from the ground contact to the shell is a safety requirement. These connectors provide a path for any stray voltage to be shunted to a safe ground, avoiding harm to the operator and the voltage sensitive equipment.

Features of Pre-Earth FMLB (DL Series) Connectors:

- MIL-5015 dimensions and performance where applicable.
- Conformity with European safety standards (DIN VDE 0627 and certified through TUV Product Service GMBH) in the approved insert arrangement.
- Offered in shell styles: 3102A box mount, 3106A straight plug, 3108A 90 degree plug.
- Intermateable with MS 5015 and 97 Series styles.
- Class IP67 protection in the mated condition.
- Main joint gasket between plug and receptacle shells provides superior moisture sealing.
- Pre-earth (ground contact) design.
- First mate, last break capability.
- Standard plating is black zinc alloy. Green zinc plating is an option.

Ask for Amphenol Product Data sheet #187 for detailed information on Pre-Earth FMLB Connectors.



Amphenol® Pre-Earth FMLB Connectors
Pre-Earth (ground) contact mates first and provides safety from voltage outputs - protects operators and sensitive circuits.

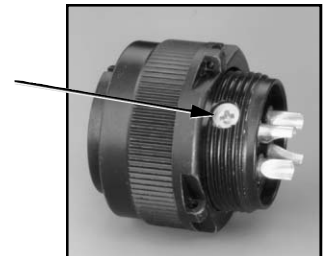

Matrix® MIL-5015 Connectors

This series provides an alternative to the older MIL-5015 solder type. It bridges the gap between an old connector standard and the environmental and high performance needs of current technologies.

Features of the Matrix MIL-5015 include:

- MS and Proprietary versions available.
- Completely sealed against environmental extremes:
 - individual contact seals
 - interfacial seals between contacts
 - peripheral gasket shell-to-shell seals
 - redundant rear wire seals and insert-to-shell seals
- 4 threaded shell styles with 172 insert patterns.
- Over 100 insert arrangements available, accommodating from a minimum of 1 to a maximum of 85 circuits.
- Thermocouple pin and socket contacts are available. Consult Amphenol, Sidney NY for information on thermocouple contacts.
- Self-locking plug available with an internal ratcheting mechanism to prevent unmating due to vibration and shock.

Ask for Amphenol Catalog 12-026 for detailed information on Matrix MIL-5015 connectors.



Matrix® MIL-5015 Connectors

See Amphenol Industrial product catalogs online at www.amphenol-industrial.com.

See Amphenol Military Aerospace product catalogs online at www.amphenol-aerospace.com.

Mouser Electronics

Authorized Distributor

Click to View Pricing, Inventory, Delivery & Lifecycle Information:

Amphenol:

[ACC02E22-22P\(025\)](#) [ACC02E28-6P\(025\)](#) [ACC02E22-7P\(025\)](#) [ACC06E16-12R\(025\)](#) [ACC06E20-19R\(025\)](#)
[ACC02E22-1P\(025\)](#) [ACC06E32-17R\(025\)](#) [ACC02E32-5P\(025\)](#) [ACC02E36-5P\(025\)](#) [ACC02E32-17P\(025\)](#)
[ACC06E18-7R\(025\)](#) [ACC06E36-4R\(025\)](#) [ACS06E12S3S](#) [ACS06E14S7S](#) [ACC06AF-10SL-4S\(025\)](#) [ACC06AF-20-27S\(025\)](#) [ACC06E-24-28S\(025\)](#) [ACS01AF-18-9P\(025\)](#) [ACS06AF-10SL-3S\(025\)](#) [ACS06AF-10SL-4S\(025\)](#) [ACS06AF-18-1S\(025\)](#) [ACS06AF-20-27S\(025\)](#) [ACS06AF-20-8S\(025\)](#) [ACS06AF-20-8SW\(025\)](#) [ACS06E-18-1S](#) [ACS06F-18-11S\(025\)](#) [ACC06AF-18-1S\(025\)](#) [ACS02E-18-3P\(025\)](#) [ACS06E-16S-1S\(472\)](#) [ACS02E-20-29S\(003\)](#) [ACS08PG1120-29S\(025\)](#) [ACC02E181P\(025\)](#) [ACS02E-28-18S\(472\)](#) [ACC06AF-20-27P\(025\)](#) [ACC00E20-19R\(025\)](#) [ACC02A22-12R\(023\)](#) [ACC02A24-22R\(024\)](#) [ACC02A32-5R\(023\)](#) [ACC02A32-6R\(023\)](#) [ACC02A36-5R\(023\)](#) [ACC02E20-24R\(023\)](#) [ACC02E22-1R\(027\)](#) [ACC02E22-23R\(025\)](#) [ACC02E28-AYR\(025\)](#) [ACC05E20-24R\(023\)](#) [ACC06AF24-9R\(023\)](#) [ACC06E24-22R\(027\)](#) [ACC06E28-6R\(023\)](#) [ACC06E32-2R\(023\)](#) [ACC06F36-5R\(025\)](#) [ACC08E22-1R\(025\)](#) [ACC08E24-22R\(024\)](#) [ACC00F36-5P\(003\)](#) [ACC00E20-19R\(003\)](#) [ACC02A14-3R\(003\)](#) [ACC02A24-22R\(003\)](#) [ACC02E22-12R\(003\)](#) [ACC02E22-1R\(003\)](#) [ACC02E28-5R\(003\)](#) [ACC02E32-6R\(003\)](#) [ACC02E36-5R\(003\)](#) [ACC05E36-5R\(003\)](#) [ACC06CF20-2R\(003\)](#) [ACC06E16-12R\(003\)](#) [ACC06E24-9R\(003\)](#) [ACC06E28-5R\(003\)](#) [ACC06F36-5R\(003\)](#) [ACC06SB32-5R\(003\)](#) [ACC08E22-1R\(003\)](#) [ACC08E36-5R\(003\)](#) [ACCL00PGR20-23R\(003\)](#) [ACC06AF-18-1P\(025\)](#) [ACC02E22-1R\(025\)](#) [ACC06E22-1R\(025\)](#) [ACC06E22-22R\(025\)](#) [ACC02E20-19P\(025\)](#) [ACC06E24-9R\(025\)](#) [ACC06E28-6R\(025\)](#) [ACC06E22-7R\(025\)](#) [ACC02E18-7P\(025\)](#) [ACC02E16-12P\(025\)](#) [ACC02E36-4P\(025\)](#) [ACC06E36-5R\(025\)](#) [ACC06E32-5R\(025\)](#) [ACC02E24-9P\(025\)](#) [ACC06AF-12S-3S\(025\)](#) [ACS06AF-14S-2S\(025\)](#) [ACS06AF-14S-7S\(025\)](#) [ACS02E-14S-6P\(025\)](#) [ACS02E-18-1S](#) [ACS05E-18-1S\(025\)](#) [ACC02E28-51P\(003\)](#) [ACC06E28-51S\(003\)](#) [ACC02E24-2P\(003\)](#) [ACC02E32-14P\(003\)](#) [ACC06E24-2S\(003\)](#) [ACC06E32-14S\(003\)](#) [ACC02E242PX003](#) [ACC02E242PW003](#) [ACC06E246SW003](#)