

**DATA LDT, LDS SWITCHES – MOMENTARY (LDT) AND LATCHING (LDS) ACTION**

**BENEFITS**

- Absolute reliability and simple assembly
- Compact design with very small mounting depth
- Excellent price/performance ratio
- Suitable for front and print-mounting
- Good illumination
- Many different application fields

		LDT	LDS
<b>Electrical data</b>			
Switching voltage	[mV] [V]	min. 100 AC / DC max. 60 AC / 50 DC	min. 100 AC / DC max. 60 AC / 50 DC
Switching current max.	[mA]	200	200
Lifetime (at rated breaking capacity 1.2W)		> 10 <sup>5</sup>	> 10 <sup>5</sup>
Initial contact resistance, new	[mΩ]	< 20	< 20
Initial contact resistance, after lifetime	[mΩ]	< 25	< 25
Insulation resistance	[Ω]	> 10 <sup>10</sup>	> 10 <sup>10</sup>
Contact bounce time	[ms]	typ. 0.5	typ. 0.5
<b>Mechanical data</b>			
Actuating force	[N]	1.2 ± 0.6	
Contact travel	[mm]	1.3 ± 0.5	
End contact travel	[mm]	2.9 ± 0.5	
End stop strength	[N]	> 50	> 50
Lifetime	[operations]	> 10 <sup>5</sup>	> 10 <sup>5</sup>
<b>Other data</b>			
Soldering method	Hand soldering(soldering terminal) or soldering bath(print terminals)		
Soldering heat resistance	[°C/s]	* 280/3(soldering)270/5(print terminals)	* 280/3(soldering)270/5(print terminals)
Ambient temperature	illuminated [°C/s]	-25 – + 60	-25 – + 60
	non-illuminated [°C/s]	-25 – + 85	-25 – + 85
Storage temperature	illuminated [°C/s]	-25 – + 60	-25 – + 60
	non-illuminated [°C/s]	-25 – + 85	-25 – + 85
Degree of protection		IP 40	IP 40
<b>Materials</b>			
Socket		Thermoplast PES	Thermoplast PES
Button		Thermoplast PC	Thermoplast PC
Contacts	gold on request	CuZn 37, mit 5 μm Ag	CuZn 37, mit 5 μm Ag
Contact spring		CuBe 37, mit 5 μm Ag	CuBe 37, mit 5 μm Ag
Terminals		CuZn 37, mit 4 μm SN Pb 40	CuZn 37, mit 4 μm SN Pb 40

LED see page 29

\* Data refers to hand soldering only, not to be used for wave soldering

## DIMENSIONS LDT, LDS SWITCHES – MOMENTARY AND LATCHING ACTION

### CONSTRUCTION

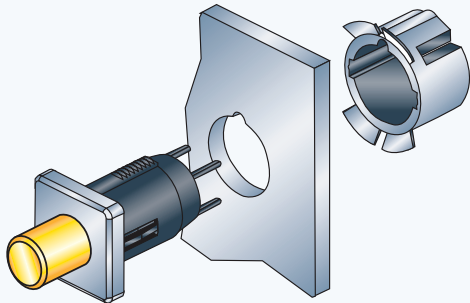

LDT / LDS, small button

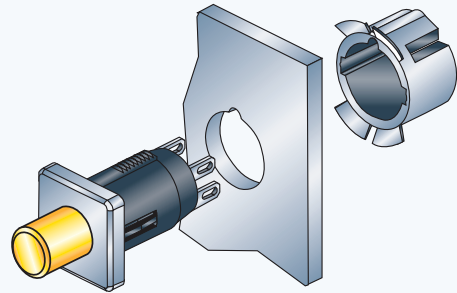

LDT / LDS, small button with solder terminal

### DIMENSIONS

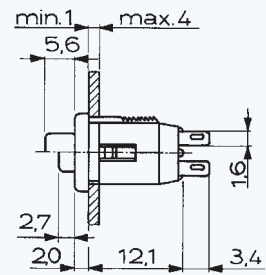
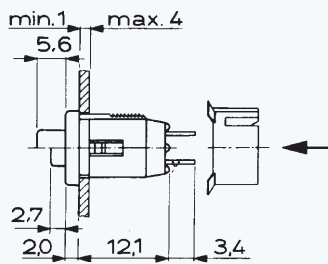

### OTHER DATA

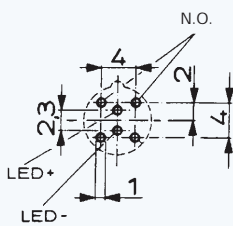

Wiring diagram

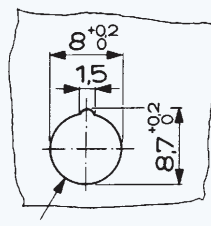

inside bevel  
< 0.2 x 45°

Front panel drilling

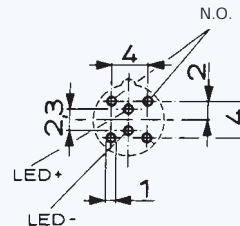

Drilling diagram

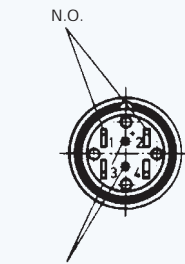

LED-terminals

Solder terminal version

### CIRCUIT DIAGRAM



NO 1 pole

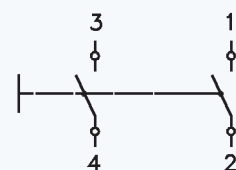

NO 2 pole

## OVERVIEW LDT, LDS SWITCHES – MOMENTARY (LDT) AND LATCHING (LDS) ACTION



In addition to the versions with the small button, further versions with a large button and switching functions are available on request.

LDT/LDS

LDT/LDS

### FEATURES

illumination	non-illuminated				illuminated					
Models	small button				small button					
<b>PART NUMBER *</b>										
LDT NO 1 pole	0041.9141.	x	x	0	x	0041.9146.	x	x	x	x
LDT NO 2 pole	0041.9142.	x	x	0	x	0041.9147.	x	x	x	x
LDS NO 1 pole	0041.9151.	x	x	0	x	0041.9156.	x	x	x	x
LDS NO 2 pole	0041.9152.	x	x	0	x	0041.9157.	x	x	x	x
<b>Colour of small button **</b>										
red		3				3				
green		5				5				
black		7								
<b>Shape of bezel/button</b>										
round			1				1			
square			3				3			
<b>Colour of LED</b>										
red									1	
green									2	
<b>Colour of bezel</b>										
black				7						7
<b>Mounting accessories</b>										

### Securing clip\*\*\*

(necessary for front panel mounting) **0850.9242**

Securing clip:



Round bezel/button :

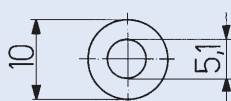

Square bezel/button :

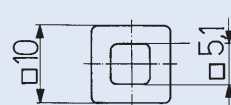

\* X in the Part No. must be replaced by the desired version  
 \*\* With the illuminated version, the small button is transparent  
 \*\*\*Securing clip must be ordered separately

## OVERVIEW LDT, LDS SWITCHES-MOMENTARY (LDT) AND LATCHING (LDS) ACTION



In addition to the versions with the small button, further versions with a large button and switching functions are available on request.

### FEATURES

illumination	non-illuminated	illuminated
Models	small button with solder terminal	small button with solder terminal

### PART NUMBER \*

LDT NO 1 pole	0041.8841.	x	x	0	x	0041.8846.	x	x	x	x
LDT NO 2 pole	0041.8842.	x	x	0	x	0041.8847.	x	x	x	x
LDS NO 1 pole	0041.8851.	x	x	0	x	0041.8856.	x	x	x	x
LDS NO 2 pole	0041.8852.	x	x	0	x	0041.8857.	x	x	x	x
Colour of small button **										
red		3					3			
green		5					5			
black		7								
Shape of bezel/button										
round			1					1		
square			3					3		
Colour of LED										
red									1	
green									2	
Colour of bezel										
black				7						7
Mounting accessories										

Securing clip\*\*\* 0850.9242

Securing clip:



Round bezel/ button:

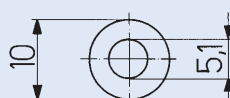

square bezel/ button:

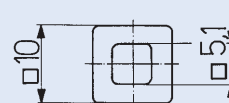

\* X in the Part No. must be replaced by the desired version  
 \*\* With the illuminated version, the small button is transparent  
 \*\*\*Securing clip is included



## LETTERING

Depending on the application and font, there are various lettering possibilities. The following standards can be used for key letterings:

### ORDER INDEX LETTERING

A = 001	P = 016	4 = 031	↕ = 046	EIN = 061
B = 002	Q = 017	5 = 032	→ = 047	AUS = 062
C = 003	R = 018	6 = 033	← = 048	AUF = 063
D = 004	S = 019	7 = 034	↓ = 049	AB = 064
E = 005	T = 020	8 = 035	↑ = 050	ON = 065
F = 006	U = 021	9 = 036	% = 051	OFF = 066
G = 007	V = 022	+ = 037	√ = 052	UP = 067
H = 008	W = 023	- = 038	CTRL = 053	DOWN = 068
I = 009	X = 024	· = 039	RETURN = 054	HIGH = 069
J = 010	Y = 025	x = 040	SHIFT = 055	LOW = 070
K = 011	Z = 026	÷ = 041	LOCK = 056	ON/OFF = 071
L = 012	0 = 027	* = 042	STOP = 057	START = 072
M = 013	1 = 028	= = 043	ENTER = 058	
N = 014	2 = 029	# = 044	BACK = 059	
O = 015	3 = 030	↔ = 045	LINE = 060	

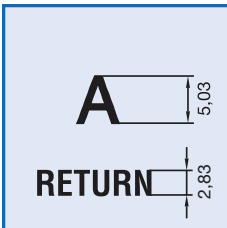

### MCS 18, LETTER HEIGHTS AND FONTS

- Single characters, Univers 65
- Legends max. 6 characters in line, Univers 65
- Insert label and front foil anthracite, RAL 7016
- Characters and symbols light grey, RAL 7035

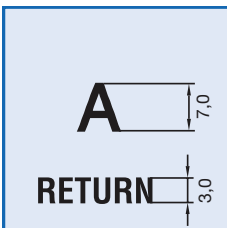

### SSM 27, LETTER HEIGHTS AND FONTS

- Single characters, Univers 65
- Legends max. 6 characters in line, Akzident-Grotesk condensed bold type
- Front foil anthracite, RAL 7016
- Characters and symbols light grey, RAL 7035



## LIGHTING TECHNOLOGY

New specification from 1.7.2011\*

### TECHNICAL DATA LEDs

1. Maximum Ratings		LED old	LED new*	LED old	LED new*	LED old	LED new*
Internal part number		0925.9730		0925.9731		0925.9732	
Light colour		red	red	green	green	yellow	yellow
Forward current DC	$I_f$ max. [mA]	40	30	40	30	40	30
Power dissipation	$P_{tot}$ max. [mW]	130	100	130	100	130	100
2. Characteristics (typ. At $T_u = 25^\circ\text{C}$ )							
Forward Voltage	at $I_f = 10\text{mA}$ , $U_f$ typ. [V]	2.0 (<2.6)	2 at 20mA	2.0 (<2.6)	2.4 at 20mA	2.0 (<2.6)	2.4 at 20mA
Luminous intensity	at $I_f = 10\text{mA}$ , $I_v$ typ. [mcd]	11.2 - 28	6.3 to...	18 - 45	6.3 to...	11.2 - 28	6.3 to...
Viewing angle	typ. [degree]	50	60	50	60	50	60
Peak wave length	typ. [nm]	635	635	565	565	586	585
Reverse voltage	$U_r$ typ. [V]	5	6	5	6	5	6

# Mouser Electronics

Authorized Distributor

Click to View Pricing, Inventory, Delivery & Lifecycle Information:

## Schurter:

[0041.8851.1107](#) [0041.8851.3107](#) [0041.8855.1107](#) [0041.8856.1137](#) [0041.8860.1137](#) [0041.9151.3107](#)  
[0041.9151.7107](#) [0041.9153.3107](#) [0041.9156.5127](#) [0041.9157.1137](#) [0041.9157.5327](#) [0041.9158.3117](#)  
[0041.9160.1337](#) [0041.9160.5127](#) [0041.9151.5307](#) [0041.9160.3317](#)