

General Description

The AAT3111 ChargePump is a MicroPower switched capacitor voltage converter that delivers a regulated output. No external inductor is required for operation. Using three small capacitors, the AAT3111 can deliver up to 150mA to the voltage regulated output. The AAT3111 features very low quiescent current and high efficiency over a large portion of its load range, making this device ideal for battery-powered applications. Furthermore, the combination of few external components and small package size keeps the total converter board area to a minimum in space-restricted applications.

The AAT3111 operates in an output-regulated voltage doubling mode. The regulator uses a pulse-skipping technique to provide a regulated output from a varying input supply. The AAT3111 contains a thermal management circuit to protect the device under continuous output short-circuit conditions.

The AAT3111 is available in a Pb-free, surface-mount 6-pin SOT23 or 8-pin SC70JW package and is rated over the -40°C to +85°C temperature range.

Features

- Step-Up Type Voltage Converter
- Input Voltage Range:
 - AAT3111-3.6: 1.8V to 3.6V
 - AAT3111-3.3: 1.8V to 3.3V
- MicroPower Consumption: 20µA
- 3.6V, 3.3V Regulated ±4% Output
- 3.6V Output Current
 - 100mA with $V_{IN} \geq 3.0V$
 - 20mA with $V_{IN} \geq 2.0V$
- 3.3V Output Current
 - 100mA with $V_{IN} \geq 2.5V$
 - 20mA with $V_{IN} \geq 1.8V$
- High Frequency 750kHz Operation
- Shutdown Mode Draws Less Than 1µA
- Short-Circuit/Over-Temperature Protection
- 2kV ESD Rating
- SC70JW-8 or SOT23-6 Package

Applications

- Battery Back-Up Supplies
- Digital Cameras
- Handheld Electronics
- MP3 Players
- PDAs

Typical Application

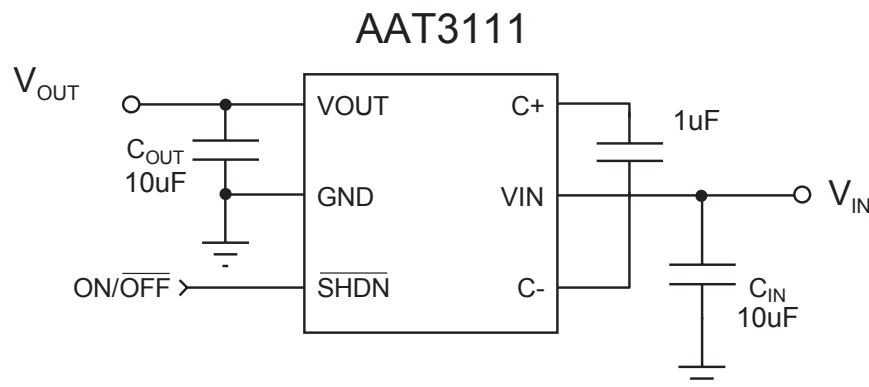

Pin Descriptions

Pin #		Symbol	Function
SOT23-6	SC70JW-8		
1	1	VOUT	Regulated output pin. Bypass this pin to ground with at least 6.8µF low Equivalent Series Resistance (ESR) capacitor.
2	2, 3, 4	GND	Ground connection.
3	5	SHDN	Shutdown input. Logic low signal disables the converter.
4	6	C-	Flying capacitor negative terminal.
5	7	VIN	Input supply pin. Bypass this pin to ground with at least 6.8µF low ESR capacitor.
6	8	C+	Flying capacitor positive terminal.

Pin Configuration

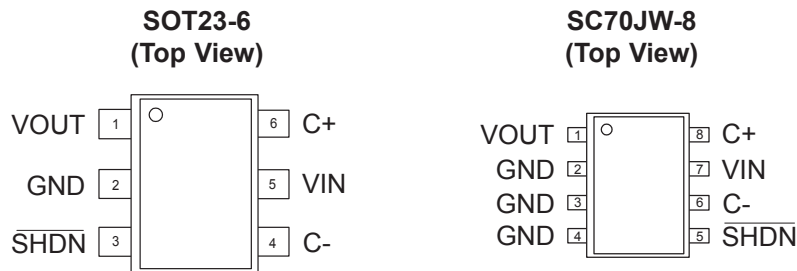

Absolute Maximum Ratings¹

$T_A = 25^\circ\text{C}$, unless otherwise noted.

Symbol	Description	Value	Units
V_{IN}	VIN to GND	-0.3 to 6	V
V_{OUT}	VOUT to GND	-0.3 to 6	V
V_{SHDN}	\overline{SHDN} to GND	-0.3 to 6	V
t_{SC}	Output to GND Short-Circuit Duration	Indefinite	s
T_J	Operating Junction Temperature Range	-40 to 150	$^\circ\text{C}$
T_{LEAD}	Maximum Soldering Temperature (at leads, 10 sec)	300	$^\circ\text{C}$
V_{ESD}	ESD Rating ² — HBM	2000	V

Thermal Information³

Symbol	Description	Rating	Units
Θ_{JA}	Maximum Thermal Resistance	150	$^\circ\text{C}/\text{W}$
P_D	Maximum Power Dissipation	667	mW

1. Stresses above those listed in Absolute Maximum Ratings may cause permanent damage to the device. Functional operation at conditions other than the operating conditions specified is not implied. Only one Absolute Maximum Rating should be applied at any one time.
 2. Human body model is a 100pF capacitor discharged through a 1.5k Ω resistor into each pin.
 3. Mounted on an FR4 board.

Electrical Characteristics

$T_A = -40^\circ\text{C}$ to $+85^\circ\text{C}$, unless otherwise noted. Typical values are $T_A = 25^\circ\text{C}$, $C_{FLY} = 1\mu\text{F}$, $C_{IN} = 10\mu\text{F}$, $C_{OUT} = 10\mu\text{F}$.

Symbol	Description	Conditions	Min	Typ	Max	Units
AAT3111-3.3						
V_{IN}	Input Voltage	$V_{OUT} = 3.3\text{V}$	1.8		V_{OUT}	V
I_Q	No Load Supply Current ¹	$1.8\text{V} < V_{IN} < 3.3\text{V}$, $I_{OUT} = 0\text{mA}$, $\overline{\text{SHDN}} = V_{IN}$		20	30	μA
V_{OUT}	Output Voltage	$1.8\text{V} < V_{IN} < 3.3\text{V}$, $I_{OUT} = 20\text{mA}$	3.17	3.30	3.43	V
		$2.5\text{V} < V_{IN} < 3.3\text{V}$, $I_{OUT} = 100\text{mA}$	3.17	3.30	3.43	
I_{SHDN}	Shutdown Supply Current	$1.8\text{V} < V_{IN} < 3.3\text{V}$, $I_{OUT} = 0\text{mA}$, $V_{\overline{\text{SHDN}}} = 0$		0.01	1	μA
V_{RIPPLE}	Ripple Voltage	$V_{IN} = 2.0\text{V}$, $I_{OUT} = 50\text{mA}$		20		mV_{P-P}
η	Efficiency	$V_{IN} = 1.8\text{V}$, $I_{OUT} = 25\text{mA}$		91		%
f_{OSC}	Frequency	Oscillator Free Running		750		kHz
V_{IH}	$\overline{\text{SHDN}}$ Input Threshold High		1.4			V
V_{IL}	$\overline{\text{SHDN}}$ Input Threshold Low				0.3	V
I_{IH}	$\overline{\text{SHDN}}$ Input Current High	$\overline{\text{SHDN}} = V_{IN}$	-1		1	μA
I_{IL}	$\overline{\text{SHDN}}$ Input Current Low	$\overline{\text{SHDN}} = \text{GND}$	-1		1	μA
t_{ON}	V_{OUT} Turn-On Time	$V_{IN} = 1.8\text{V}$, $I_{OUT} = 0\text{mA}$		0.2		ms
I_{SC}	Short-Circuit Current ²	$V_{IN} = 1.8\text{V}$, $V_{OUT} = \text{GND}$, $\overline{\text{SHDN}} = 3\text{V}$		300		mA
AAT3111-3.6						
V_{IN}	Input Voltage	$V_{OUT} = 3.6\text{V}$	1.8		V_{OUT}	V
I_Q	No Load Supply Current ¹	$1.8\text{V} < V_{IN} < 3.6\text{V}$, $I_{OUT} = 0\text{mA}$, $\overline{\text{SHDN}} = V_{IN}$		20	30	μA
V_{OUT}	Output Voltage	$2.0\text{V} < V_{IN} < 3.6\text{V}$, $I_{OUT} \leq 20\text{mA}$	3.46	3.6	3.74	V
		$3.0\text{V} < V_{IN} < 3.6\text{V}$, $I_{OUT} \leq 100\text{mA}$	3.46	3.6	3.74	
I_{SHDN}	Shutdown Supply Current	$1.8\text{V} < V_{IN} < 3.6\text{V}$, $I_{OUT} = 0\text{mA}$, $V_{\overline{\text{SHDN}}} = 0$		0.01	1	μA
V_{RIPPLE}	Ripple Voltage	$V_{IN} = 2.5\text{V}$, $I_{OUT} = 50\text{mA}$		25		mV_{P-P}
		$V_{IN} = 3\text{V}$, $I_{OUT} = 100\text{mA}$		30		
η	Efficiency	$V_{IN} = 2.0\text{V}$, $I_{OUT} = 20\text{mA}$		90		%
f_{OSC}	Frequency	Oscillator Free Running		750		kHz
V_{IH}	$\overline{\text{SHDN}}$ Input Threshold High		1.4			V
V_{IL}	$\overline{\text{SHDN}}$ Input Threshold Low				0.3	V
I_{IH}	$\overline{\text{SHDN}}$ Input Current High	$\overline{\text{SHDN}} = V_{IN}$	-1		1	μA
I_{IL}	$\overline{\text{SHDN}}$ Input Current Low	$\overline{\text{SHDN}} = \text{GND}$	-1		1	μA
t_{ON}	V_{OUT} Turn-On Time	$V_{IN} = 1.8\text{V}$, $I_{OUT} = 0\text{mA}$		0.2		ms
I_{SC}	Short-Circuit Current ²	$V_{IN} = 1.8\text{V}$, $V_{OUT} = \text{GND}$, $\overline{\text{SHDN}} = 3\text{V}$		300		mA

1. Under short-circuit conditions, the device may enter over-temperature protection mode.

2. $I_Q = I_{VIN} + I_{VOUT}$. V_{OUT} is pulled up to 3.8V to prevent switching.

Typical Characteristics — AAT3111-3.3

Unless otherwise noted, $V_{IN} = 3V$, $C_{IN} = C_{OUT} = 10\mu F$, $C_{FLY} = 1\mu F$, $T_A = 25^\circ C$.

Output Voltage vs. Output Current

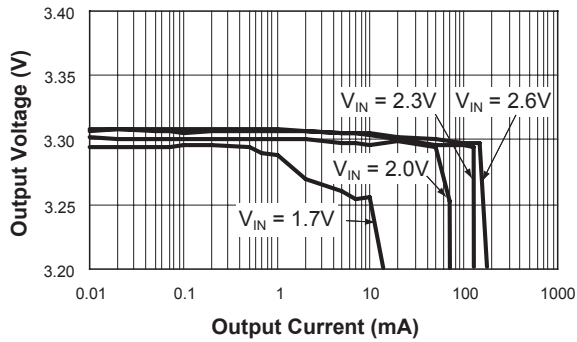

Supply Current vs. Supply Voltage

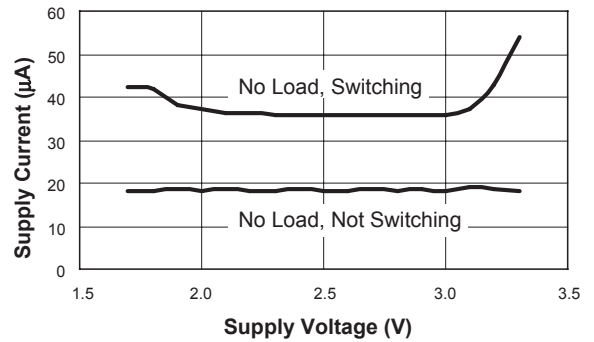

Efficiency vs. Supply Voltage

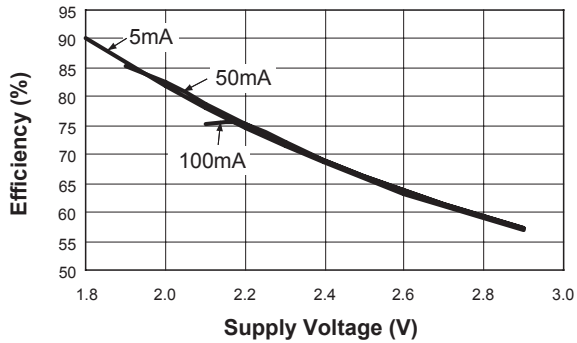

Efficiency vs. Load Current

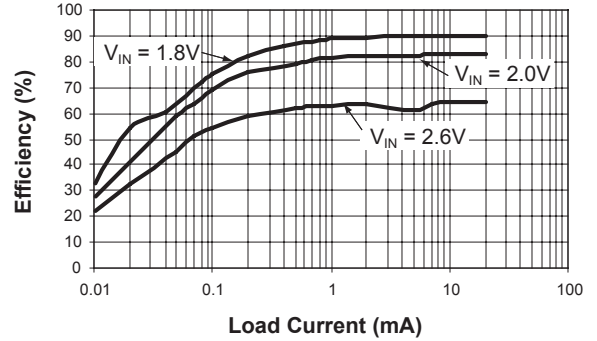

Startup

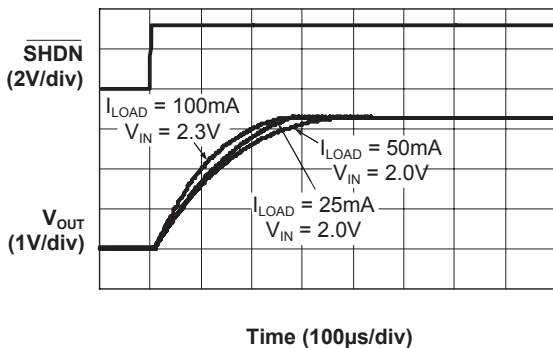

V_{SHDN} Threshold vs. Supply Voltage

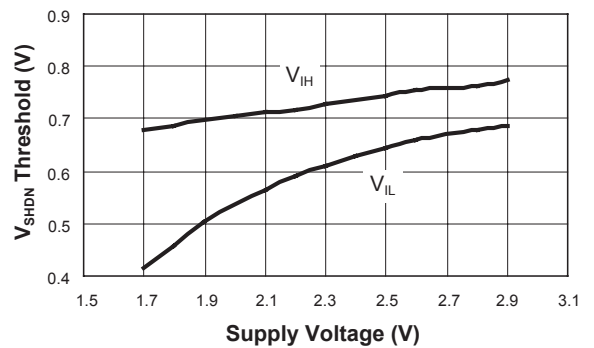

Typical Characteristics — AAT3111-3.3

Unless otherwise noted, $V_{IN} = 3V$, $C_{IN} = C_{OUT} = 10\mu F$, $C_{FLY} = 1\mu F$, $T_A = 25^\circ C$.

Load Transient Response
($V_{IN} = 2.0V$)

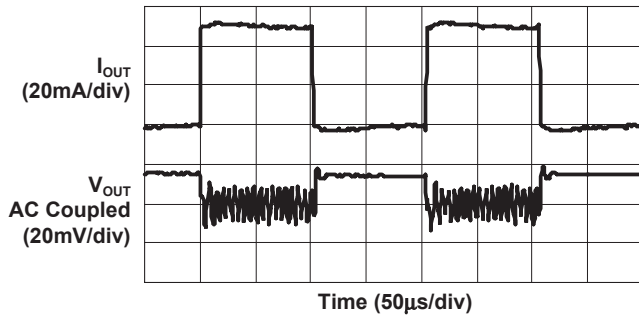

Load Transient Response
($V_{IN} = 2.6V$)

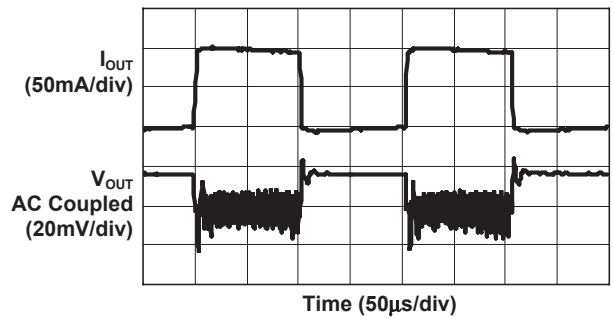

Output Ripple
($I_{OUT} = 50mA$; $V_{IN} = 2.0V$)

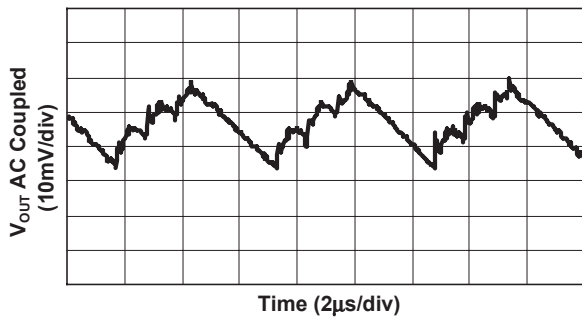

Output Ripple
($I_{OUT} = 100mA$; $V_{IN} = 2.5V$)

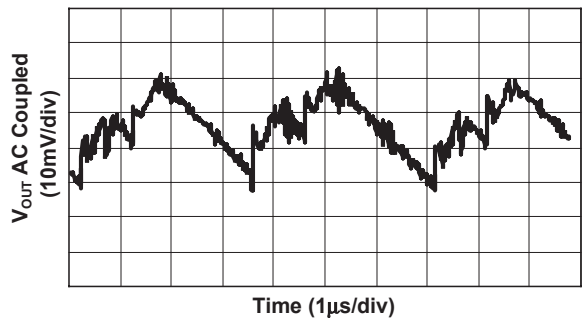

Typical Characteristics — AAT3111-3.6

Unless otherwise noted, $V_{IN} = 3V$, $C_{IN} = C_{OUT} = 10\mu F$, $C_{FLY} = 1\mu F$, $T_A = 25^\circ C$.

Output Voltage vs. Output Current

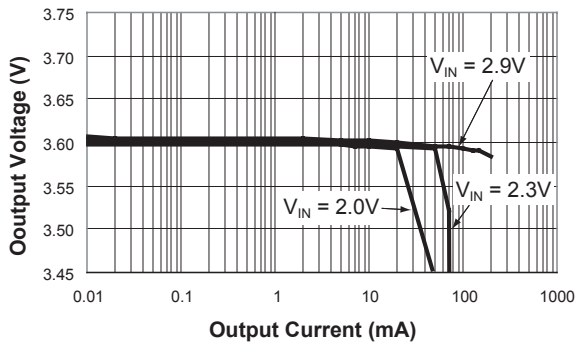

Supply Current vs. Supply Voltage

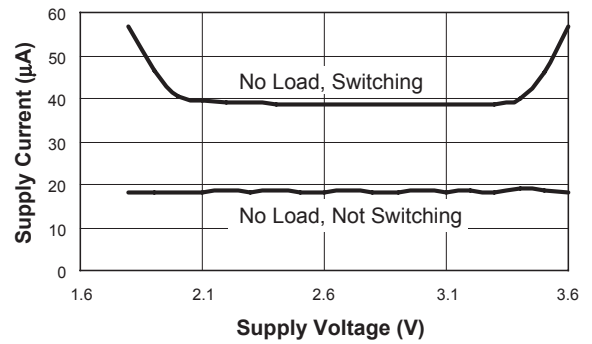

Efficiency vs. Supply Voltage

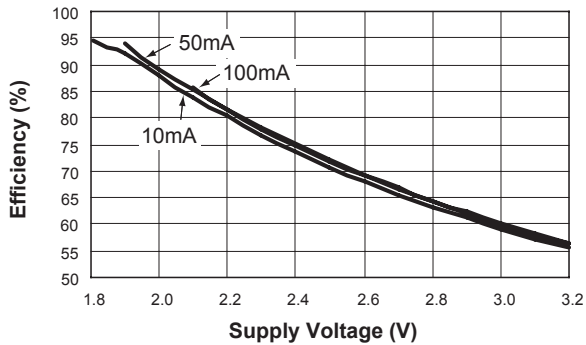

Efficiency vs. Load Current

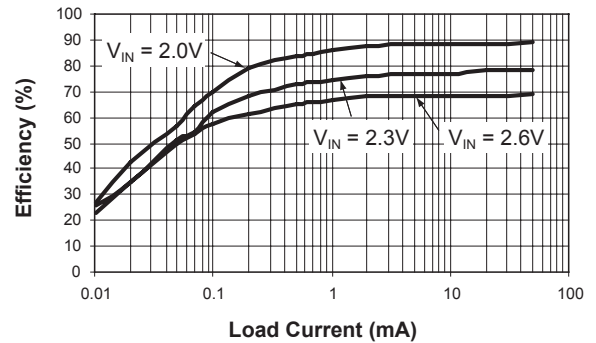

Startup

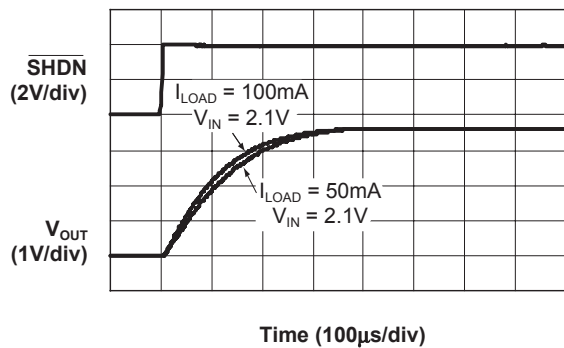

V_{SHDN} Threshold vs. Supply Voltage

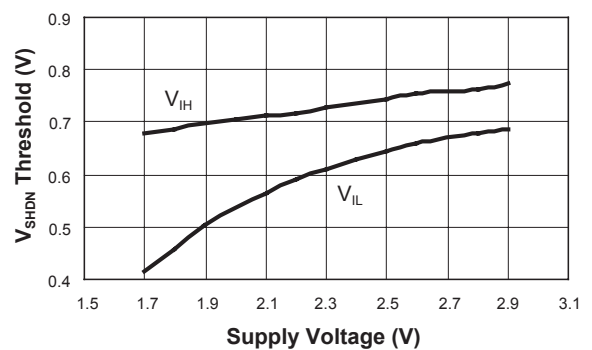

Typical Characteristics — AAT3111-3.6

Unless otherwise noted, $V_{IN} = 3V$, $C_{IN} = C_{OUT} = 10\mu F$, $C_{FLY} = 1\mu F$, $T_A = 25^\circ C$.

Load Transient Response
($V_{IN} = 2.1V$)

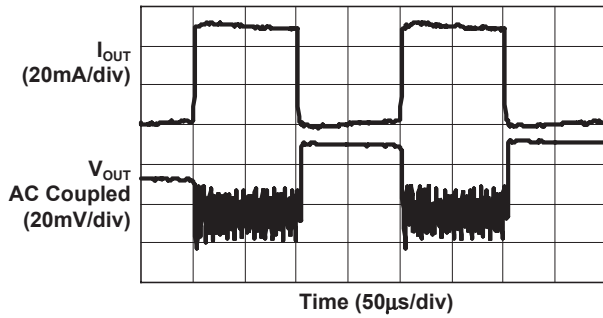

Load Transient Response
($V_{IN} = 2.4V$)

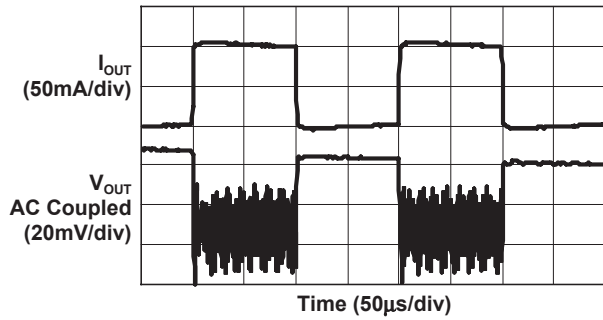

Output Ripple
($I_{OUT} = 50mA$; $V_{IN} = 2.5V$)

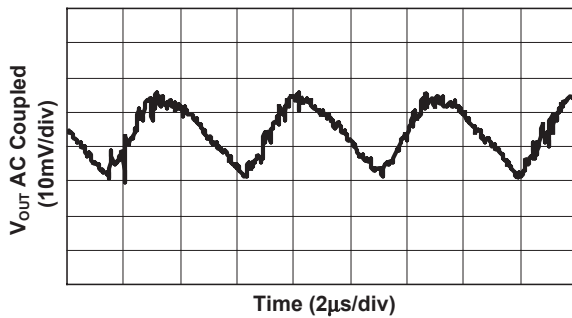

Output Ripple
($I_{OUT} = 100mA$; $V_{IN} = 3.0V$)

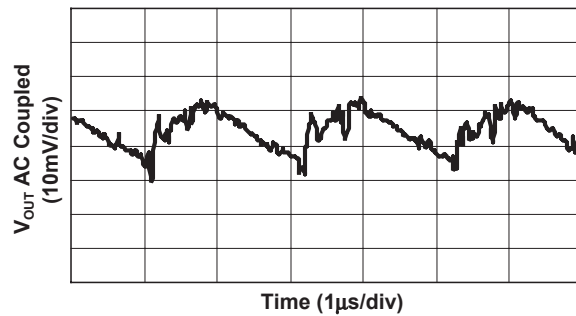

Functional Block Diagram

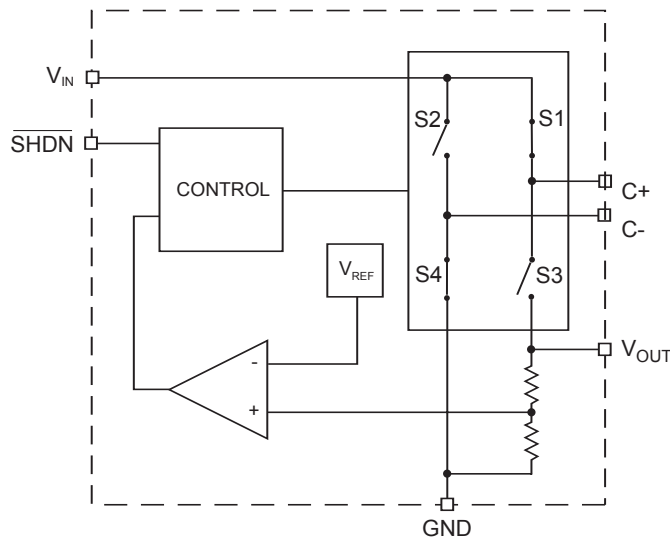

Functional Description

Operation (Refer to block diagram)

The AAT3111 uses a switched capacitor charge pump to boost an input voltage to a regulated output voltage. Regulation is achieved by sensing the charge pump output voltage through an internal resistor divider network. A switched doubling circuit is enabled when the divided output drops below a preset trip point controlled by an internal comparator. The charge pump switch cycling enables four internal switches at two non-overlapping phases. During the first phase, switches S1 and S4 are switched on (short) and switches S2 and S3 are off (open). The flying capacitor C_{FLY} is charged to a level approximately equal to input voltage V_{IN} . On the second phase, switches S1 and S4 are turned off (open), and S2 and S3 are turned on (short). The low side of the flying capacitor C_{FLY} is connected to GND during the first phase. During the second phase, the flying capacitor C_{FLY} is switched so that the low side is connected to V_{IN} . The voltage at the high side of the flying capacitor C_{FLY} is bootstrapped to $2 \times V_{IN}$ and is connected to the output through switch S3. For each cycle phase, charge from input node V_{IN} is transported from a lower voltage to a higher voltage. This cycle repeats itself until the output node voltage is high enough to exceed the preset input threshold of the control comparator. When the output voltage exceeds the internal trip point level, the switching cycle stops and the charge pump circuit is tem-

porarily placed in an idle state. When idle, the AAT3111 has a quiescent current of 20 μ A or less. The closed loop feedback system containing the voltage sense circuit and control comparator allows the AAT3111 to provide a regulated output voltage to the limits of the input voltage and output load current. The switching signal, which drives the charge pump, is created by an integrated oscillator within the control circuit block. The free-running charge pump switching frequency is approximately 750kHz. The switching frequency under a load is a function of V_{IN} , V_{OUT} , C_{OUT} , and I_{OUT} .

For each phase of the switching cycle, the charge transported from V_{IN} to V_{OUT} can be approximated by the following formula:

$$V_{PHASE} \approx C_{FLY} \cdot (2 \cdot V_{IN} - V_{OUT})$$

The relative average current that the charge pump can supply to the output may be approximated by the following expression:

$$I_{OUT(AVG)} \propto C_{FLY} \cdot (2 \cdot V_{IN} - V_{OUT}) \cdot F_S$$

The AAT3111 has complete output short-circuit and thermal protection to safeguard the device under extreme operating conditions. An internal thermal protection circuit senses die temperature and will shut down the device if the internal junction temperature exceeds approximately 145°C. The charge pump will remain disabled until the fault condition is relieved.

External Capacitor Selection

Careful selection of the three external capacitors C_{IN} , C_{OUT} , and C_{FLY} is very important because they will affect turn-on time, output ripple, and transient performance. Optimum performance will be obtained when low ESR ceramic capacitors are used. In general, low ESR may be defined as less than $100\text{m}\Omega$. If desired for a particular application, low ESR tantalum capacitors may be substituted; however, optimum output ripple performance may not be realized. Aluminum electrolytic capacitors are not recommended for use with the AAT3111 due to their inherent high ESR characteristic.

Typically as a starting point, a capacitor value of $10\mu\text{F}$ should be used for C_{IN} and C_{OUT} with $1\mu\text{F}$ for C_{FLY} when the AAT3111 is used under maximum output load conditions. Lower values for C_{IN} , C_{OUT} , and C_{FLY} may be utilized for light load current applications. Applications drawing a load current of 10mA or less may use a C_{IN} and C_{OUT} capacitor value as low as $1\mu\text{F}$ and a C_{FLY} value of $0.1\mu\text{F}$. C_{IN} and C_{OUT} may range from $1\mu\text{F}$ for light loads to $10\mu\text{F}$ or more for heavy output load conditions. C_{FLY} may range from $0.01\mu\text{F}$ to $2.2\mu\text{F}$ or more. If C_{FLY} is increased, C_{OUT} should also be increased by the same ratio to minimize output ripple. As a basic rule, the ratio between C_{IN} , C_{OUT} , and C_{FLY} should be approximately 10 to 1. The compromise for lowering the value of C_{IN} , C_{OUT} , and the flying capacitor C_{FLY} is the output ripple voltage may be increased. In any case, if the external capacitor values deviate greatly from the recommendation of $C_{IN} = C_{OUT} = 10\mu\text{F}$ and $C_{FLY} = 1\mu\text{F}$, the AAT3111 output performance should be evaluated to assure the device meets application requirements.

In applications where the input voltage source has very low impedance, it is possible to omit the C_{IN} capacitor. However, if C_{IN} is not used, circuit performance should be evaluated to assure desired operation is achieved. Under high peak current operating conditions that are typically experienced during circuit start-up or when load demands create a large inrush current, poor output voltage regulation can result if the input supply source impedance is high, or if the value of C_{IN} is too low. This situation can be remedied by increasing the value of C_{IN} .

Capacitor Characteristics

Ceramic composition capacitors are highly recommended over all other types of capacitors for use with the AAT3111. Ceramic capacitors offer many advantages over their tantalum and aluminum electrolytic counterparts. A ceramic capacitor typically has very low ESR, is lower cost, has a smaller PCB footprint, and is non-polarized. Low ESR ceramic capacitors help maximize charge pump transient response. Since ceramic capacitors are non-polarized, they are not prone to incorrect connection damage.

Equivalent Series Resistance: ESR is a very important characteristic to consider when selecting a capacitor. ESR is a resistance internal to a capacitor that is caused by the leads, internal connections, size or area, material composition, and ambient temperature. Typically capacitor ESR is measured in milliohms for ceramic capacitors and can range to more than several ohms for tantalum or aluminum electrolytic capacitors.

Ceramic Capacitor Materials: Ceramic capacitors less than $0.1\mu\text{F}$ are typically made from NPO or C0G materials. NPO and C0G materials generally have tight tolerance and are very stable over temperature. Larger capacitor values are usually composed of X7R, X5R, Z5U, or Y5V dielectric materials. Large ceramic capacitors (i.e., greater than $2.2\mu\text{F}$) are often available in low-cost Y5V and Z5U dielectrics. If these types of capacitors are selected for use with the charge pump, the nominal value should be doubled to compensate for the capacitor tolerance which can vary more than $\pm 50\%$ over the operating temperature range of the device. A $10\mu\text{F}$ Y5V capacitor could be reduced to less than $5\mu\text{F}$ over temperature; this could cause problems for circuit operation. X7R and X5R dielectrics are much more desirable. The temperature tolerance of X7R dielectric is better than $\pm 15\%$.

Capacitor area is another contributor to ESR. Capacitors that are physically large will have a lower ESR when compared to an equivalent material smaller capacitor. These larger devices can improve circuit transient response when compared to an equal value capacitor in a smaller package size.

Charge Pump Efficiency

The AAT3111 is a regulated output voltage doubling charge pump. The efficiency (η) can simply be defined as a linear voltage regulator with an effective output voltage that is equal to two times the input voltage. Efficiency (η) for an ideal voltage doubler can typically be expressed as the output power divided by the input power.

$$\eta = \frac{P_{OUT}}{P_{IN}}$$

In addition, with an ideal voltage doubling charge pump, the output current may be expressed as half the input current. The expression to define the ideal efficiency (η) can be rewritten as:

$$\eta = \frac{P_{OUT}}{P_{IN}} = \frac{V_{OUT} \cdot I_{OUT}}{V_{IN} \cdot 2I_{OUT}} = \frac{V_{OUT}}{2V_{IN}}$$

-or-

$$\eta(\%) = 100 \left(\frac{V_{OUT}}{2V_{IN}} \right)$$

For a charge pump with an output of 3.3 volts and a nominal input of 1.8 volts, the theoretical efficiency is 91.6%. Due to internal switching losses and IC quiescent current consumption, the actual efficiency can be measured at 91%. These figures are in close agreement for output load conditions from 1mA to 100mA. Efficiency will decrease as load current drops below 0.05mA or when the level of V_{IN} approaches V_{OUT} . Refer to the Typical Characteristics section for measured plots of efficiency versus input voltage and output load current for the given charge pump output voltage options.

Short-Circuit and Thermal Protection

In the event of a short-circuit condition, the charge pump can draw as much as 100mA to 400mA of current from V_{IN} . This excessive current consumption due to an output short-circuit condition will cause a rise in the internal IC junction temperature. The AAT3111 has a thermal protection and shutdown circuit that continuously monitors the IC junction

temperature. If the thermal protection circuit senses the die temperature exceeding approximately 145°C, the thermal shutdown will disable the charge pump switching cycle operation. The thermal limit system has 10°C of system hysteresis before the charge pump can reset. Once the over-current event is removed from the output and the junction temperature drops below 135°C, the charge pump will then become active again. The thermal protection system will cycle on and off if an output short-circuit condition persists. This will allow the AAT3111 to operate indefinitely in a short-circuit condition without damage to the device.

Output Ripple and Ripple Reduction

There are several factors that determine the amplitude and frequency of the charge pump output ripple, the values of C_{OUT} and C_{FLY} , the load current I_{OUT} , and the level of V_{IN} . Ripple observed at V_{OUT} is typically a sawtooth waveform in shape. The ripple frequency will vary depending on the load current I_{OUT} and the level of V_{IN} . As V_{IN} increases, the ability of the charge pump to transfer charge from the input to the output becomes greater; as it does, the peak-to-peak output ripple voltage will also increase.

The size and type of capacitors used for C_{IN} , C_{OUT} , and C_{FLY} have an effect on output ripple. Since output ripple is associated with the R/C charge time constant of these two capacitors, the capacitor value and ESR will contribute to the resulting charge pump output ripple. This is why low ESR capacitors are recommended for use in charge pump applications. Typically, output ripple is not greater than 35mV_{P-P} when $V_{IN} = 2.0V$, $V_{OUT} = 3.3V$, $C_{OUT} = 10\mu F$, and $C_{FLY} = 1\mu F$.

When the AAT3111 is used in light output load applications where $I_{OUT} < 10mA$, the flying capacitor C_{FLY} value can be reduced. The reason for this effect is when the charge pump is under very light load conditions, the transfer of charge across C_{FLY} is greater during each phase of the switching cycle. The result is higher ripple seen at the charge pump output. This effect will be reduced by decreasing the value of C_{FLY} . Caution should be observed when decreasing the flying capacitor. If the output load current rises above the nominal level for the reduced C_{FLY} value, charge pump efficiency can be compromised.

There are several methods that can be employed to reduce output ripple depending upon the requirements of a given application. The most simple and straightforward technique is to increase the value of the C_{OUT} capacitor. The nominal $10\mu\text{F}$ C_{OUT} capacitor can be increased to $22\mu\text{F}$ or more. Larger values for the C_{OUT} capacitor ($22\mu\text{F}$ and greater) will by nature have lower ESR and can improve both high and low frequency components of the charge pump output ripple response. If a higher value tantalum capacitor is used for C_{OUT} to reduce low frequency ripple elements, a small $1\mu\text{F}$ low ESR ceramic capacitor should be added in parallel to the tantalum capacitor (see Figure 1). The reason for this is tantalum capacitors typically have higher ESR than equivalent value ceramic capacitors and are less able to reduce high-frequency components of the output ripple. The only disadvantage to using large values for the C_{OUT} capacitor is the AAT3111 device turn-on time and inrush current may be increased.

If additional ripple reduction is desired, an R/C filter can be added to the charge pump output in addition to the C_{OUT} capacitor (see Figure 2). An R/C

filter will reduce output ripple by primarily attenuating high frequency components of the output ripple waveform. The low frequency break point for the R/C filter will significantly depend on the capacitor value selected.

Layout Considerations

High charge pump switching frequencies and large peak transient currents mandate careful printed circuit board layout. As a general rule for charge pump boost converters, all external capacitors should be located as closely as possible to the device package with minimum length trace connections. Maximize the ground plane around the AAT3111 charge pump and make sure all external capacitors are connected to the immediate ground plane. A local component side ground plane is recommended. If this is not possible due the layout design limitations, assure good ground connections by the use of large or multiple PCB vias.

Refer to the AAT3111 evaluation board for an example of good charge pump layout design (Figures 3 through 5).

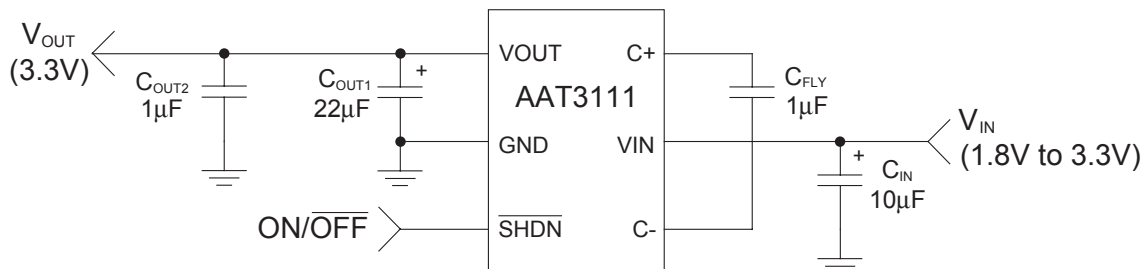

Figure 1: Application Using Tantalum Capacitor.

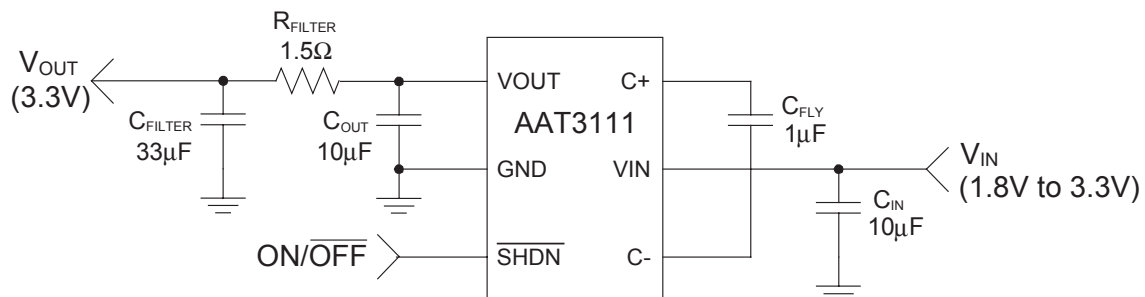
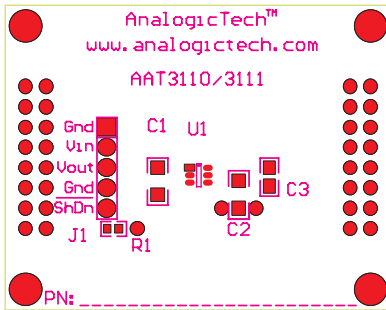
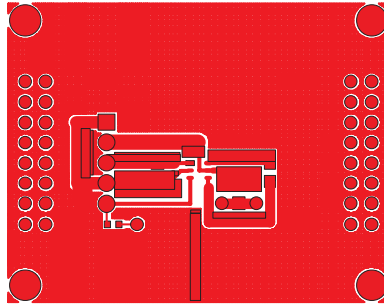

Figure 2: Application With Output Ripple Reduction Filter.



**Figure 3: Evaluation Board
Top Side Silk Screen Layout /
Assembly Drawing.**



**Figure 4: Evaluation Board
Component Side Layout.**

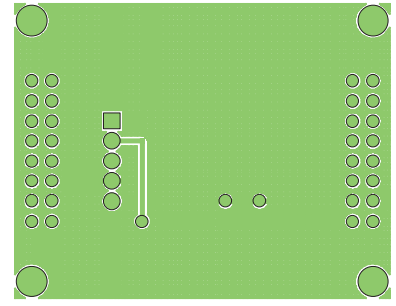

**Figure 5: Evaluation Board
Solder Side Layout.**

Typical Application Circuit

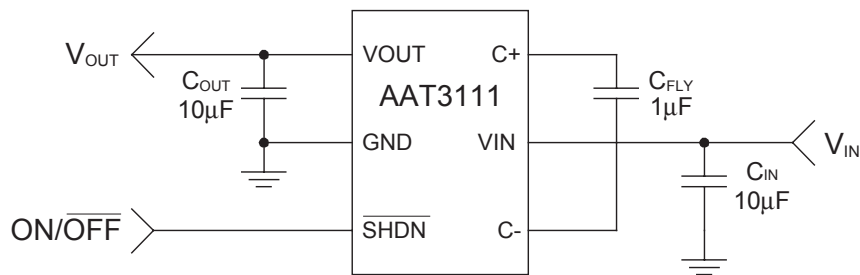

Figure 6: Typical Charge Pump Boost Converter Circuit.

Ordering Information

Output Voltage	Package	Marking ¹	Part Number (Tape and Reel) ²
3.3V	SOT23-6	BPXY	AAT3111IGU-3.3-T1
3.6V	SOT23-6	BOXYY	AAT3111IGU-3.6-T1
3.3V	SC70JW-8	BPXY	AAT3111IJS-3.3-T1
3.6V	SC70JW-8	BOXYY	AAT3111IJS-3.6-T1



All AnalogicTech products are offered in Pb-free packaging. The term “Pb-free” means semiconductor products that are in compliance with current RoHS standards, including the requirement that lead not exceed 0.1% by weight in homogeneous materials. For more information, please visit our website at <http://www.analogictech.com/pbfree>.

1. XYY = assembly and date code.

2. Sample stock is generally held on part numbers listed in **BOLD**.

Package Information

SOT23-6

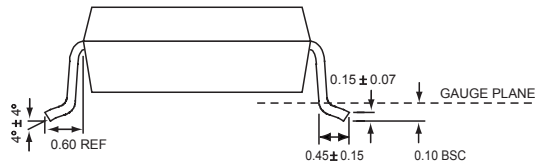
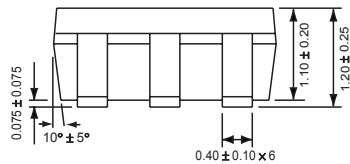
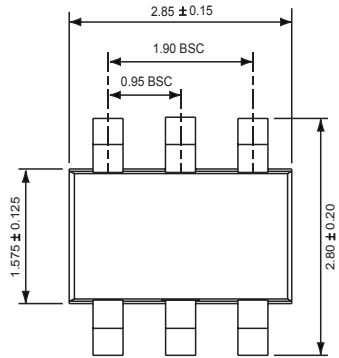

SC70JW-8

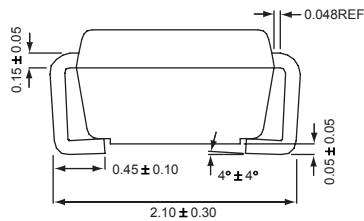
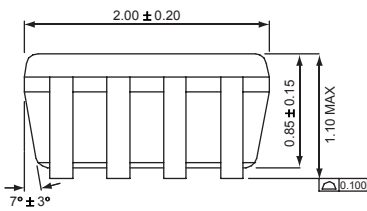
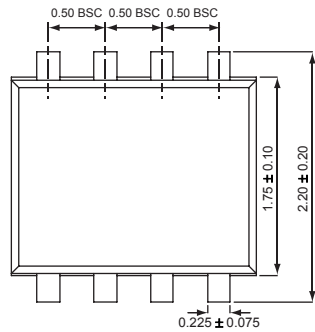

All dimensions in millimeters.

© Advanced Analogic Technologies, Inc.

AnalogicTech cannot assume responsibility for use of any circuitry other than circuitry entirely embodied in an AnalogicTech product. No circuit patent licenses, copyrights, mask work rights, or other intellectual property rights are implied. AnalogicTech reserves the right to make changes to their products or specifications or to discontinue any product or service without notice. Customers are advised to obtain the latest version of relevant information to verify, before placing orders, that information being relied on is current and complete. All products are sold subject to the terms and conditions of sale supplied at the time of order acknowledgement, including those pertaining to warranty, patent infringement, and limitation of liability. AnalogicTech warrants performance of its semiconductor products to the specifications applicable at the time of sale in accordance with AnalogicTech's standard warranty. Testing and other quality control techniques are utilized to the extent AnalogicTech deems necessary to support this warranty. Specific testing of all parameters of each device is not necessarily performed.

AnalogicTech and the AnalogicTech logo are trademarks of Advanced Analogic Technologies Incorporated. All other brand and product names appearing in this document are registered trademarks or trademarks of their respective holders.

Advanced Analogic Technologies, Inc.
830 E. Arques Avenue, Sunnyvale, CA 94085
Phone (408) 737-4600
Fax (408) 737-4611

