



## FEATURES

- Standard quarter-brick package/pinout
- Outputs from 1.5 to 48V up to 125W
- Low profile 0.42" height
- 24 and 48Vdc nominal inputs
- Fully isolated, 2250Vdc (BASIC) insulation
- Designed for RoHS-6 compliance
- Output overvoltage/short-circuit protected
- On/Off control, trim and sense functions
- High efficiency to 92%
- Protected against temp. and voltage limits
- Designed to meet UL/IEC/EN60950-1 safety approvals

## PRODUCT OVERVIEW

For efficient, fully isolated DC power in the smallest space, Murata Power Solutions' UVQ series quarter bricks offer output voltages from 1.5 to 48 Volts with currents up to 40 Amps. UVQs operate over a wide temperature range (up to +70°C at 200 lfm airflow) at full-rated power. The optional mounting baseplate extends this to all practical temperature ranges at full power.

UVQs achieve these impressive specifications while delivering excellent electrical performance. Overall noise is 35mVp-p (3.3V models) with fast step response (down to 50µsec). These converters offer high stability even with no load and tight output regulation. The unit is fully protected against input over and undervoltage, output over-current and short circuit. An on-board temperature sensor shuts down the converter if thermal limits are reached. Protection uses the "hiccup" (auto restart) method.

A convenient remote On/Off control input operates by external digital logic, relay or transistor input. To compensate for longer wiring and to retain output voltage accuracy at the load, UVQs include a Sense input to dynamically correct for ohmic losses. A trim input may be connected to a user's adjustment potentiometer or trim resistors for output voltage calibration closer than the standard accuracy.

UVQs include industry-standard safety certifications and BASIC I/O insulation provides 2250 Volt input/output isolation. Radiation emission testing is performed to widely-accepted EMC standards. The UVQs may be considered as higher performance replacements for some Murata Power Solutions USQ models.

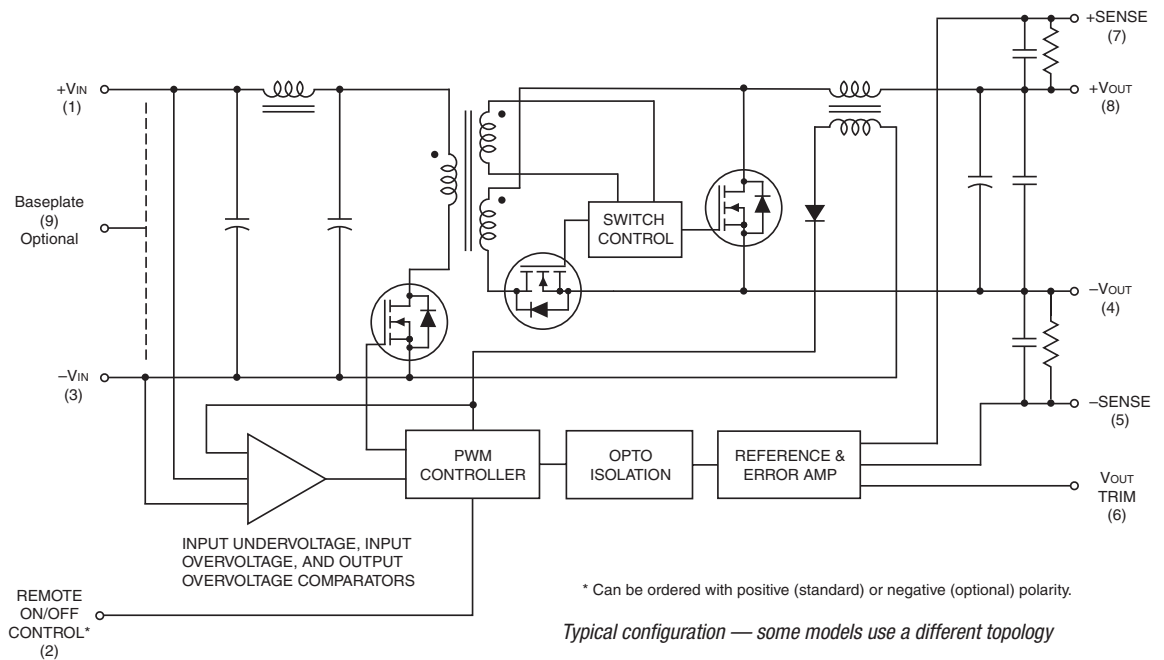

Figure 1. Simplified Schematic



For full details go to  
[www.murata-ps.com/rohs](http://www.murata-ps.com/rohs)

| PERFORMANCE SPECIFICATIONS SUMMARY AND ORDERING GUIDE |                          |                         |               |             |      |                     |         |                              |               |                                |                                    |       |                        |       |          |
|---|--------------------------|-------------------------|---------------|-------------|------|---------------------|---------|------------------------------|---------------|--------------------------------|------------------------------------|-------|------------------------|-------|----------|
| Root Models   | Output                   |                         |               |             |      |                     | Input   |                              |               |                                | Efficiency                         |       | Package (Case, Pinout) |       |          |
|   | V <sub>OUT</sub> (Volts) | I <sub>OUT</sub> (Amps) | Power (Watts) | R/N (mVp-p) |      | Regulation (Max.) ③ |         | V <sub>IN</sub> Nom. (Volts) | Range (Volts) | I <sub>IN</sub> , No Load (mA) | I <sub>IN</sub> , Full Load (Amps) | Min.  |                        | Typ.  |          |
|   |                          |                         |               | Typ.        | Max. | Line                | Load    |                              |               |                                |                                    |       |                        |       |          |
| Discontinued  | UVQ-1.5/40-D24P-C        | 1.5                     | 40            | 60          | 30   | 60                  | ±0.075% | ±0.05%                       | 24            | 18-36                          | 80                                 | 2.84  | 86.5%                  | 88%   | C59, P32 |
| Discontinued  | UVQ-2.5/35-D24P-C        | 2.5                     | 35            | 87.5        | 35   | 60                  | ±0.05%  | ±0.05%                       | 24            | 18-36                          | 100                                | 4.14  | 86%                    | 88%   |          |
| Discontinued  | UVQ-2.5/40-D48N-C        |                         | 40            | 100         |      | 60                  | ±0.05%  | ±0.05%                       | 48            | 36-75                          | 100                                | 2.37  | 87%                    | 88%   |          |
| Discontinued  | UVQ-3.3/30-D24P-C ②      | 3.3                     | 30            | 99          | 65   | ±0.1%               | ±0.25%  | 24                           | 18-36         | 180                            | 4.58                               | 88.5% | 90%                    |       |          |
| Discontinued  | UVQ-3.3/35-D48N-C ②      |                         | 35            | 115.5       | 40   | ±0.05%              | ±0.25%  | 48                           | 36-75         | 130                            | 2.7                                | 87%   | 89%                    |       |          |
| Available   | UVQ-5/20-D24P-C          | 5                       | 20            | 100         | 30   | 50                  | ±0.05%  | ±0.05%                       | 24            | 18-36                          | 190                                | 4.53  | 91%                    | 92%   |          |
| Available   | UVQ-5/20-D48N-C          |                         |               |             | 20   | 25                  | ±0.05%  | ±0.05%                       | 48            | 36-75                          | 80                                 | 2.31  | 88.5%                  | 90%   |          |
| Available   | UVQ-12/8-D24P-C          | 12                      | 8             | 96          | 95   | 130                 | ±0.1%   | ±0.1%                        | 24            | 18-36                          | 90                                 | 4.4   | 89%                    | 91%   |          |
| Available   | UVQ-12/10-D48N-C         |                         | 10            | 120         | 110  | 160                 | ±0.075% | ±0.05%                       | 48            | 36-75                          | 60                                 | 2.78  | 88.5%                  | 90%   |          |
| Available   | UVQ-15/7-D24P-C          | 15                      | 7             | 105         | 85   | 150                 | ±0.05%  | ±0.05%                       | 24            | 18-36                          | 103                                | 4.85  | 88.5%                  | 90.3% |          |
| Available   | UVQ-15/7-D48N-C          |                         |               |             | 120  | 150                 | ±0.05%  | ±0.02%                       | 48            | 36-75                          | 60                                 | 2.39  | 90%                    | 91.5% |          |
| Available   | UVQ-18/5.6-D24P-C        | 18                      | 5.6           | 100.8       | 125  | 185                 | ±0.05%  | ±0.075%                      | 24            | 18-36                          | 140                                | 4.69  | 88%                    | 89.5% |          |
| Available   | UVQ-18/6-D48N-C          |                         | 6             | 100.8       | 125  | 185                 | ±0.05%  | ±0.075%                      | 48            | 36-75                          | 80                                 | 2.5   | 88.3%                  | 90%   |          |
| Available   | UVQ-24/4.5-D24P-C        | 24                      | 4.5           | 108         | 60   | 100                 | ±0.075% | ±0.15%                       | 24            | 18-36                          | 45                                 | 5.03  | 88%                    | 89.5% |          |
| Available   | UVQ-24/4.5-D48N-C        |                         |               |             | 75   | 130                 | ±0.075% | ±0.25%                       | 48            | 36-75                          | 45                                 | 2.49  | 89%                    | 90.5% |          |
| Available   | UVQ-48/2.5-D24P-C        | 48                      | 2.5           | 120         | 100  | 200                 | ±0.1%   | ±0.2%                        | 24            | 18-36                          | 45                                 | 4.4   | 89%                    | 91%   |          |
| Available   | UVQ-48/2.5-D48N-C        |                         |               |             | 250  | 375                 | ±0.175% | ±0.2%                        | 48            | 36-75                          | 30                                 | 2.71  | 91%                    | 92.3% |          |

- Discontinued
- Discontinued
- Discontinued
- Discontinued
- Discontinued
- Available
- Available
- Available
- Available
- Available
- Available
- Available
- Available
- Available
- Available
- Available
- Available
- Available

- ① These are partial model numbers. Please refer to the full model number structure for complete ordering part numbers.
- ② Min. I<sub>OUT</sub> = 3 Amps for UVQ-3.3 V<sub>OUT</sub> models.
- ③ All specifications are at nominal line voltage and full load, +25°C unless otherwise noted. See detailed specifications.

- Output capacitors are 1uF ceramic || 10 uF electrolytic. Input cap is 22 uF, low ESR, except UVQ-24/4.5 is 33uF and UVQ-48/2.5 uses no input cap. I/O caps are necessary for our test equipment and may not be needed for your application.
- ④ I<sub>OUT</sub> = 14 Amps max. with V<sub>IN</sub> = 18-19.5 Volts.

**Model UVQ-31128-C** is a standard model UVQ-5/20-D48NB-C with modified rise time to reach 4.75V within 10 mSec. All other specifications are as per the standard product.

**UVQ Pin 9 Baseplate Connection**

The UVQ series may include an optional installed baseplate for extended thermal management. Various UVQ models (see list below) are also available with an additional pin 9 on special order which connects to the baseplate but is electrically isolated from the rest of the converter. Please refer to the mechanical drawings.

Pin 9 offers a positive method of controlling the electrical potential of the baseplate, independent of the converter. Some baseplate models cannot include pin 9 and in such cases, the baseplate is grounded by the mounting bolts. Or consider adding an external lugged washer with a grounding terminal.

The baseplate may be ordered by adding a “B” to the model number tree and pin 9 will be pre-installed by adding a “9”. The two options are separate. Please refer to the Ordering Guide. Do not order pin 9 without the baseplate. Note that “pin 9” converters may be on limited forecast, requiring minimum order quantities and scheduled deliveries.

Models available with Pin 9:

- UVQ-12/10-D48
- UVQ-1.5/40-D24

Models which are NOT available with Pin 9:

- UVQ-5/20-D24 and -D48
- UVQ-3.3/30-D24
- UVQ-3.3/35-D48
- UVQ-2.5/35-D24
- UVQ-2.5/40-D48

Other models which are not listed will be reviewed for future pin 9 accommodation.

**PART NUMBER STRUCTURE**

**U VQ - 3.3 / 20 - D48 N B 9 LX - C**

**Output Configuration**  
U = Unipolar/Single

**Quarter-Brick Package**

**Nominal Output Voltage**  
1.2 to 48 Volts

**Maximum Rated Output**  
Current in Amps

**Input Voltage Range:**  
D24 = 18-36 Volts (24V nominal)  
D48 = 36-75 Volts (48V nominal)

**RoHS-6 hazardous substance compliant**  
(does not claim EU RoHS exemption 7b-lead in solder)

**Alternate Pin Length:** (special quantity order)  
Blank = Standard pin length  
L1 = 0.110 (2.79mm)  
L2 = 0.145 (3.68mm)

**Baseplate Pin 9, see Mechanical Drawings:** (special order)  
Blank = No pin 9, standard  
9 = Pin 9 installed (see description on pg. 2), optional

Blank = No baseplate, standard  
B = Baseplate installed, optional special order

**Remote On/Off Control Logic:**  
Add "P" for positive logic  
Add "N" for negative logic  
Positive "P" logic is standard for D24 models and optional special order for D48 models. Negative "N" logic is standard for D48 models and optional special order for D24 models.

**\* Note:**  
Some model number combinations may not be available. Contact Murata Power Solutions.

| ORDERING GUIDE SUMMARY |                        |                        |                       |                             |
|------------------------|------------------------|------------------------|-----------------------|-----------------------------|
| Model                  | V <sub>OUT</sub> Range | I <sub>OUT</sub> Range | V <sub>IN</sub> Range | Efficiency                  |
| All Models             | 1.2V to 48V            | 2.5A to 40A            | 18-36V or 36-75V      | Up to 92.%, model dependent |

| INPUT CHARACTERISTICS |                        |                            |  |
|-----------------------|------------------------|----------------------------|--|
| Parameter             | Typ. @ 25°C, full load | Notes                      |  |
| Voltage Range         | 18-36 or 36-75 Volts   | 24V or 48V nominal         |  |
| Current, full power   | Up to 5.6 Amps         | Model dependent            |  |
| Isolation             | 2kVdc to 2250V         | Model dependent            |  |
| Remote On/Off Control | Switch or FET control  | Positive or negative logic |  |

| OUTPUT CHARACTERISTICS     |                                |                          |  |
|----------------------------|--------------------------------|--------------------------|--|
| Parameter                  | Typ. @ 25°C, full load         | Notes                    |  |
| Voltage                    | 1.5 to 48 Volts ±10%           | Trimmable                |  |
| Current                    | 2.5 to 40 Amps fullscale       | No minimum load          |  |
| Accuracy                   | Down to 1% of V <sub>NOM</sub> | Most models              |  |
| Ripple & Noise (to 20MHz)  | Down to 35mVp-p                | Model dependent          |  |
| Line and Load Regulation   | Down to ±0.125%/±0.25%         | Model dependent          |  |
| Overcurrent Protection     | 150% of I <sub>OUT</sub> max.  | With hiccup auto-restart |  |
| Overtemperature Protection | +125°C                         |                          |  |
| Efficiency (minimum)       | See Performance Specifications |                          |  |

| GENERAL SPECIFICATIONS      |                        |                                    |  |
|-----------------------------|------------------------|------------------------------------|--|
| Parameter                   | Typ. @ 25°C, full load | Notes                              |  |
| Dynamic Load Response       | Down to 50µsec         | Model dependent                    |  |
| Operating Temperature Range | -40 to +110°C          | With baseplate, see derating curve |  |
| Safety                      | UL/IEC/EN 60950-1      | and CSA C22.2-No.234               |  |

| MECHANICAL CHARACTERISTICS |  |
|----------------------------|--|
| With baseplate             | 1.45 x 2.30 x 0.5 inches (36.83 x 58.42 x 12.7 mm)   |
| Without baseplate          | 1.45 x 2.30 x 0.42 inches (36.83 x 58.42 x 10.67 mm) |

See Performance Specifications, page 2

## Performance/Functional Specifications 24V Models

Typical @  $T_A = +25^\circ\text{C}$  under nominal line voltage, nominal output voltage, natural air convection, external caps and full-load conditions, unless noted. (1)

|   | UVQ-1.5/40-D24  | UVQ-2.5/35-D24 | UVQ-3.3/30-D24 | UVQ-5/20-D24 | UVQ-12/8-D24 | UVQ-15/7-D24 | UVQ-18/5.6-D24 | UVQ-24/4.5-D24 | UVQ-48/2.5-D24 |
|---|---|----------------|----------------|--------------|--------------|--------------|----------------|----------------|----------------|
| <b>Input</b>  |   |                |                |              |              |              |                |                |                |
| Input voltage range                                 | See ordering guide  |                |                |              |              |              |                |                |                |
| Start-up threshold, (V) min.                        | 17  | 17             | 17             | 17           | 17           | 17           | 17             | 17             | 17             |
| Undervoltage shutdown, (V) <sup>14</sup>            | 16  |                |                | 16.25        |              | 16           | 16.25          | 16             | 16             |
| Overshoot shutdown (V)                              | none  |                |                |              | 39           |              |                | none           |                |
| Reflected (back) ripple current <sup>2</sup>        | 10-50 mA pk-pk, model dependent                                     |                |                |              |              |              |                |                |                |
| <b>Input Current</b>                                |   |                |                |              |              |              |                |                |                |
| Full load conditions                                | See ordering guide.   |                |                |              |              |              |                |                |                |
| Inrush transient, (A <sup>2</sup> sec)              | 0.5   | 0.5            | 0.05           | 0.5          | 0.1          | 1            | 1              | 0.05           | 0.05           |
| Output short circuit, (mA)                          | 40  | 50             |                |              | 10           | 320          | 50             | 50             | 50             |
| No load, mA   | 80  | 100            | 180            | 190          | 90           | 103          | 140            | 45             | 30             |
| Low line ( $V_{IN} = \text{min.}$ ), (Amps)         | 3.79  | 5.49           | 6.04           | 5.57         | 5.93         | 6.52         | 6.29           | 6.67           | 3.60           |
| Standby mode, (Off, UV, OT shutdown)                | 1-4mA, model dependent  |                |                |              |              |              |                |                |                |
| Internal input filter type                          | L-C   |                |                |              |              |              | Pi-type        |                | L-C            |
| Reverse polarity protection                         | See notes.  |                |                |              |              |              |                |                |                |
| <b>Remote On/Off Control<sup>5</sup></b>            |   |                |                |              |              |              |                |                |                |
| Positive logic, "P" suffix (specifications are max) | OFF = Ground pin to +0.8V<br>ON = Open or +5V to + $V_{IN}$ max.    |                |                |              |              |              |                |                |                |
| Negative logic, "N" suffix (specifications are max) | OFF = Open or +5V to + $V_{IN}$ max<br>ON = Ground pin to +0.8V max |                |                |              |              |              |                |                |                |
| Current   | 1-8 mA, model dependent   |                |                |              |              |              |                |                |                |

## Performance/Functional Specifications 24V Models

Typical @ T<sub>A</sub> = +25°C under nominal line voltage, nominal output voltage, natural air convection, external caps and full-load conditions, unless noted. (1)

|  | UVQ-1.5/40-D24  | UVQ-2.5/35-D24 | UVQ-3.3/30-D24 | UVQ-5/20-D24               | UVQ-12/8-D24   | UVQ-15/7-D24 | UVQ-18/5.6-D24          | UVQ-24/4.5-D24 | UVQ-48/2.5-D24             |
|--|---|----------------|----------------|----------------------------|----------------|--------------|-------------------------|----------------|----------------------------|
| <b>Output</b>  |   |                |                |                            |                |              |                         |                |                            |
| Voltage output range   | See ordering guide.   |                |                |                            |                |              |                         |                |                            |
| Voltage output accuracy (50% load)                                       | ±1.5% of V <sub>NOM</sub>   |                |                | ±1.25% of V <sub>NOM</sub> |                |              | ±1% of V <sub>NOM</sub> |                |                            |
| Adjustment range   | -20 to +10% of V <sub>NOM</sub> .                                   |                |                |                            |                |              |                         |                | ±10% of V <sub>NOM</sub> . |
| Temperature coefficient  | ±0.02% of V <sub>OUT</sub> range per °C                             |                |                |                            |                |              |                         |                |                            |
| Minimum loading  | No minimum load   | 3 amps         |                | No minimum load            |                |              |                         |                |                            |
| Remote sense compensation  | +10%.   |                |                |                            |                |              |                         |                |                            |
| Ripple/noise   | See ordering guide.   |                |                |                            |                |              |                         |                |                            |
| Line/Load regulation   | See ordering guide.   |                |                |                            |                |              |                         |                |                            |
| Efficiency   | See ordering guide.   |                |                |                            |                |              |                         |                |                            |
| Maximum capacitive loading, Low ESR <0.02Ω max., resistive load, (μF)    | 10,000  |                |                | 5000                       | 4700           |              |                         | 2200           |                            |
| Current limit inception (98% of V <sub>OUT</sub> , after warmup), (Amps) | 45  | 44             | 36             | 24                         | 10             | 9.5          | 7.2                     | 5.8            | 3.4                        |
| Short circuit protection method  | Current limiting, hiccup autorestart. Remove overload for recovery. |                |                |                            |                |              |                         |                |                            |
| Short circuit current, (Amps)  | 3.6   | 3              | 3              | 3                          | 1.5            | 15 mA        | 3                       | 5              | 2.8                        |
| Short circuit duration   | Output may be shorted continuously to ground (no damage).           |                |                |                            |                |              |                         |                |                            |
| Overvoltage protection, (via magnetic feedback)                          | 2.3 Volts   | 3 Volts max    | 4 Volts max    | 6.8 Volts max              | 14.4 Volts max | 18.5 Volts   | 22 Volts max            | 29 Volts max   | 59 Volts max               |
| <b>Isolation Characteristics</b>   |   |                |                |                            |                |              |                         |                |                            |
| Isolation Voltage  |   |                |                |                            |                |              |                         |                |                            |
| Input to Output, (Volts min)   | 2000  |                |                |                            |                |              |                         |                |                            |
| Input to baseplate   | 1500  |                |                |                            |                |              |                         |                |                            |
| Baseplate to output, (Volts min)   | 1500  |                |                | 1000                       | 1500           |              |                         |                |                            |
| Isolation resistance   | 100 MΩ  |                |                |                            |                |              |                         |                |                            |
| Isolation capacitance, (pF)  | 1500  |                |                |                            | 1000           | 2000         | 50                      |                |                            |
| Isolation safety rating  | Basic insulation  |                |                |                            |                |              |                         |                |                            |

## Performance/Functional Specifications 24V Models

Typical @ TA = +25°C under nominal line voltage, nominal output voltage, natural air convection, external caps and full-load conditions, unless noted. (1)

|  | UVQ-1.5/40-D24  | UVQ-2.5/35-D24                   | UVQ-3.3/30-D24                   | UVQ-5/20-D24                     | UVQ-12/8-D24                  | UVQ-15/7-D24                     | UVQ-18/5.6-D24                | UVQ-24/4.5-D24                 | UVQ-48/2.5-D24                 |  |
|--|---|----------------------------------|----------------------------------|----------------------------------|-------------------------------|----------------------------------|-------------------------------|--------------------------------|--------------------------------|--|
| <b>Dynamic characteristics</b>   |   |                                  |                                  |                                  |                               |                                  |                               |                                |                                |  |
| Dynamic load response (50-75-50% load step)                                      | 100 µSec to ±1% of final value  | 150 µSec to ±1.5% of final value | 150 µSec to ±1.5% of final value | 100 µSec to ±1.5% of final value | 50 µSec to ±1% of final value | 40 µSec to ±1.25% of final value | 50 µSec to ±1% of final value | 100 µSec to ±1% of final value | 100 µSec to ±1% of final value |  |
| Start-up time<br>VIN to VOUT regulated, mSec                                     | 90msec  | 50msec                           | 50msec                           | 200msec                          | 40msec                        | 30msec                           | 30msec                        | 290msec                        | 100msec                        |  |
| Remote On/Off to VOUT regulated, mSec  | 90msec  | 50msec                           | 50msec                           | 200msec                          | 30msec                        | 25msec                           | 35msec                        | 200msec                        | 100msec                        |  |
| Switching frequency, (KHz)   | 380 ± 30  | 500 to 650                       | 600                              | 360                              | 290 ± 30                      | 242                              | 240 ± 25                      | 290 ± 30                       | 250 ± 25                       |  |
| <b>Environmental</b>   |   |                                  |                                  |                                  |                               |                                  |                               |                                |                                |  |
| Calculated MTBF <sup>4</sup>   | TBD   |                                  |                                  |                                  |                               |                                  |                               |                                |                                |  |
| Operating temperature range: see Derating Curves.                                | –40 to +85°C (with Derating, see Note 15.)                            |                                  |                                  |                                  |                               |                                  |                               |                                |                                |  |
| Operating temperature, with baseplate, no derating required (°C) <sup>3</sup>    | –40 to +110   |                                  |                                  |                                  |                               | –40 to +115                      |                               | –40 to +110                    |                                |  |
| Storage temperature (°C)   | –55 to +130   |                                  |                                  |                                  |                               |                                  |                               |                                | –55 to +125                    |  |
| Thermal protection/shutdown  | +110 to 125°C, model dependent  |                                  |                                  |                                  |                               |                                  |                               |                                |                                |  |
| Relative humidity  | To +85°C/85%, non-condensing  |                                  |                                  |                                  |                               |                                  |                               |                                |                                |  |
| <b>Physical</b>  |   |                                  |                                  |                                  |                               |                                  |                               |                                |                                |  |
| Outline dimensions   | See mechanical specs.   |                                  |                                  |                                  |                               |                                  |                               |                                |                                |  |
| Baseplate material   | Aluminum  |                                  |                                  |                                  |                               |                                  |                               |                                |                                |  |
| Pin material   | Copper alloy  |                                  |                                  |                                  |                               |                                  |                               |                                |                                |  |
| Pin diameter   | 0.040/0.062 inches (1.016/1.575 mm)                                   |                                  |                                  |                                  |                               |                                  |                               |                                |                                |  |
| Weight   | 1.55 ounce (44 grams)   | 1 ounce (28 grams)               |                                  |                                  |                               |                                  |                               |                                |                                |  |
| Electromagnetic interference (conducted and radiated) (external filter required) | Designed to meet FCC part 15, class B, EN55022                        |                                  |                                  |                                  |                               |                                  |                               |                                |                                |  |
| Safety   | Designed to meet UL/cUL 60950-1, CSA C22.2 No.60950-1, IEC/EN 60950-1 |                                  |                                  |                                  |                               |                                  |                               |                                |                                |  |

## Performance/Functional Specifications 48V Models

Typical @  $T_A = +25^\circ\text{C}$  under nominal line voltage, nominal output voltage, natural air convection, external caps and full-load conditions, unless noted. (1)

|   | UVQ-2.5/40-D48  | UVQ-3.3/35-D48 | UVQ-5/20-D48 | UVQ-12/10-D48 | UVQ-15/7-D48 | UVQ-18/6-D48 | UVQ-24/4.5-D48 | UVQ-48/2.5-D48 |
|---|---|----------------|--------------|---------------|--------------|--------------|----------------|----------------|
| <b>Input</b>  |   |                |              |               |              |              |                |                |
| Input voltage range                                 | See ordering guide  |                |              |               |              |              |                |                |
| Start-up threshold, min (V)                         | 35  |                | 34.5         | 34            | 34.5         | 35           |                |                |
| Undervoltage shutdown, (V) <sup>14</sup>            | 33.5  |                |              | 32            |              |              | 33.5           |                |
| Overshoot shutdown (V)                              | none  |                |              |               |              |              |                |                |
| Reflected (back) ripple current                     | 10-50 mA pk-pk, model dependent                                     |                |              |               |              |              |                |                |
| <b>Input Current</b>                                |   |                |              |               |              |              |                |                |
| Full load conditions                                | See ordering guide.   |                |              |               |              |              |                |                |
| Inrush transient, (A <sup>2</sup> sec)              | 0.05  | 0.05           | 1            | 1             | 0.05         | 1            | 0.05           | 0.05           |
| Output short circuit, (mA)                          | 50  |                |              | 10            | 30           | 50           | 250            | 50             |
| No load, mA   | 100   | 130            | 80           | 60            | 30           | 80           | 45             | 30             |
| Low line ( $V_{IN} = \text{min.}$ ), (Amps)         | 3.15  | 3.56           | 3.07         | 3.72          | 3.21         | 3.35         | 3.30           | 3.60           |
| Standby mode, (Off, UV, OT shutdown)                | 1-4mA, model dependent  |                |              |               |              |              |                |                |
| Internal input filter type                          | L-C   |                |              |               | Pi-type      |              |                | L-C            |
| Reverse polarity protection                         | See notes.  |                |              |               |              |              |                |                |
| <b>Remote On/Off Control<sup>5</sup></b>            |   |                |              |               |              |              |                |                |
| Positive logic, "P" suffix (specifications are max) | OFF = Ground pin to +0.8V<br>ON = Open or +5V to + $V_{IN}$ max     |                |              |               |              |              |                |                |
| Negative logic, "N" suffix (specifications are max) | OFF = Open or +5V to + $V_{IN}$ max<br>ON = Ground pin to +0.8V max |                |              |               |              |              |                |                |
| Current   | 1-8 mA, model dependent   |                |              |               |              |              |                |                |

## Performance/Functional Specifications 48V Models

Typical @ T<sub>A</sub> = +25°C under nominal line voltage, nominal output voltage, natural air convection, external caps and full-load conditions, unless noted. (1)

|  | UVQ-2.5/40-D48  | UVQ-3.3/35-D48 | UVQ-5/20-D48               | UVQ-12/10-D48   | UVQ-15/7-D48            | UVQ-18/6-D48 | UVQ-24/4.5-D48 | UVQ-48/2.5-D48             |
|--|---|----------------|----------------------------|-----------------|-------------------------|--------------|----------------|----------------------------|
| <b>Output</b>  |   |                |                            |                 |                         |              |                |                            |
| Voltage output range   | See ordering guide.   |                |                            |                 |                         |              |                |                            |
| Voltage output accuracy (50% load)                                       | ±1.5% of V <sub>NOM</sub>   |                | ±1.25% of V <sub>NOM</sub> |                 | ±1% of V <sub>NOM</sub> |              |                |                            |
| Adjustment range   | –20 to +10% of V <sub>NOM</sub> .                                   |                |                            |                 |                         |              |                | +10% of V <sub>NOM</sub> . |
| Temperature coefficient  | ±0.02% of V <sub>OUT</sub> range per °C                             |                |                            |                 |                         |              |                |                            |
| Minimum loading  | No minimum load   | 3 Amps         | No minimum load            | No minimum load |                         |              |                |                            |
| Remote sense compensation  | +10%.   |                |                            |                 |                         |              |                |                            |
| Ripple/noise   | See ordering guide.   |                |                            |                 |                         |              |                |                            |
| Line/Load regulation   | See ordering guide.   |                |                            |                 |                         |              |                |                            |
| Efficiency   | See ordering guide.   |                |                            |                 |                         |              |                |                            |
| Maximum capacitive loading, Low ESR <0.02Ω max., resistive load, (μF)    | 10,000  |                | 4700                       |                 | 2200                    |              | 1000           |                            |
| Current limit inception (98% of V <sub>OUT</sub> , after warmup), (Amps) | 46  | 48             | 26                         | 12.5            | 8.5                     | 7            | 6.5            | 3.3                        |
| Short circuit protection method  | Current limiting, hiccup autorestart. Remove overload for recovery. |                |                            |                 |                         |              |                |                            |
| Short circuit current, (Amps)  | 5   |                | 0.1                        | 1.5             | 3                       | 3            | 3              | 3.5                        |
| Short circuit duration   | Output may be shorted continuously to ground (no damage).           |                |                            |                 |                         |              |                |                            |
| Overvoltage protection, (via magnetic feedback)                          | 3 Volts max   | 4 Volts max    | 6 Volts max                | 14.4 Volts max  | 18.5 Volts max          | 22 Volts max | 29 Volts max   | 55 Volts max               |
| <b>Isolation Characteristics</b>   |   |                |                            |                 |                         |              |                |                            |
| Isolation Voltage  |   |                |                            |                 |                         |              |                |                            |
| Input to Output, (Volts min)   | 2250  |                |                            |                 |                         |              |                |                            |
| Input to baseplate   | 1500  |                |                            |                 |                         |              |                |                            |
| Baseplate to output, (Volts min)   | 1500  |                |                            |                 | 1500                    |              |                |                            |
| Isolation resistance   | 100 MΩ  |                |                            |                 |                         |              |                |                            |
| Isolation capacitance, (pF)  | 1500  |                | 1000                       | 50              |                         | 50           | 1500           |                            |
| Isolation safety rating  | Basic insulation  |                |                            |                 |                         |              |                |                            |



## Performance/Functional Specifications 48V Models

Typical @ TA = +25°C under nominal line voltage, nominal output voltage, natural air convection, external caps and full-load conditions, unless noted. (1)

|  | UVQ-2.5/40-D48  | UVQ-3.3/35-D48                      | UVQ-5/20-D48                     | UVQ-12/10-D48                    | UVQ-15/7-D48                     | UVQ-18/6-D48                     | UVQ-24/4.5-D48                    | UVQ-48/2.5-D48                   |
|--|---|-------------------------------------|----------------------------------|----------------------------------|----------------------------------|----------------------------------|-----------------------------------|----------------------------------|
| <b>Dynamic characteristics</b>   |   |                                     |                                  |                                  |                                  |                                  |                                   |                                  |
| Dynamic load response<br>(50-75-50% load step)   | 150 µSec to ±1.5%<br>of final value                                   | 150 µSec to ±1.5%<br>of final value | 90 µSec to ±2%<br>of final value | 50 µSec to ±1%<br>of final value | 50 µSec to ±1%<br>of final value | 50 µSec to ±1%<br>of final value | 100 µSec to ±1%<br>of final value | 75 µSec to ±1%<br>of final value |
| Start-up time<br>VIN to VOUT regulated, mSec   | 50msec  | 50msec                              | 50msec                           | 40msec                           | 30msec                           | 30msec                           | 100msec                           | 50msec                           |
| Remote On/Off to VOUT<br>regulated, mSec   | 50msec  | 50msec                              | 50msec                           | 30msec                           | 30msec                           | 30msec                           | 100msec                           | 50msec                           |
| Switching frequency, (KHz)   | 600   | 600                                 | 450 ± 50                         | 290 ± 30                         | 245 ± 20                         | 240 ± 25                         | 290 ± 30                          | 540 ± 40                         |
| <b>Environmental</b>   |   |                                     |                                  |                                  |                                  |                                  |                                   |                                  |
| Calculated MTBF <sup>4</sup>   | TBD   |                                     |                                  |                                  |                                  |                                  |                                   |                                  |
| Operating temperature<br>range: see Derating<br>Curves.                                      | –40 to +85°C (with Derating, see Note 15.)                            |                                     |                                  |                                  |                                  |                                  |                                   |                                  |
| Operating temperature,<br>with baseplate, no<br>derating required (°C) <sup>3</sup>          | –40 to +110   |                                     |                                  | –40 to +115                      |                                  | –40 to +110                      | –40 to +110                       | –40 to +120                      |
| Storage temperature (°C)   | –55 to +125   |                                     |                                  |                                  |                                  |                                  |                                   |                                  |
| Thermal protection/<br>shutdown  | +110 to 125°C, model dependent  |                                     |                                  |                                  |                                  |                                  |                                   |                                  |
| Relative humidity  | To +85°C/85%, non-condensing  |                                     |                                  |                                  |                                  |                                  |                                   |                                  |
| <b>Physical</b>  |   |                                     |                                  |                                  |                                  |                                  |                                   |                                  |
| Outline dimensions   | See mechanical specs.   |                                     |                                  |                                  |                                  |                                  |                                   |                                  |
| Baseplate material   | Aluminum  |                                     |                                  |                                  |                                  |                                  |                                   |                                  |
| Pin material   | Copper alloy  |                                     |                                  |                                  |                                  |                                  |                                   |                                  |
| Pin diameter   | 0.040/0.062 inches (1.016/1.575 mm)                                   |                                     |                                  |                                  |                                  |                                  |                                   |                                  |
| Weight   | 1 ounce (28 grams)  |                                     |                                  |                                  |                                  |                                  |                                   |                                  |
| Electromagnetic<br>interference<br>(conducted and<br>radiated)<br>(external filter required) | Designed to meet FCC part 15, class B, EN55022                        |                                     |                                  |                                  |                                  |                                  |                                   |                                  |
| Safety   | Designed to meet UL/cUL 60950-1, CSA C22.2 No.60950-1, IEC/EN 60950-1 |                                     |                                  |                                  |                                  |                                  |                                   |                                  |

**TYPICAL PERFORMANCE DATA**

**UVQ-1.5/40-D24N: Maximum Current Temperature Derating**  
(No baseplate,  $V_{IN} = 24V$ , transverse air flow)

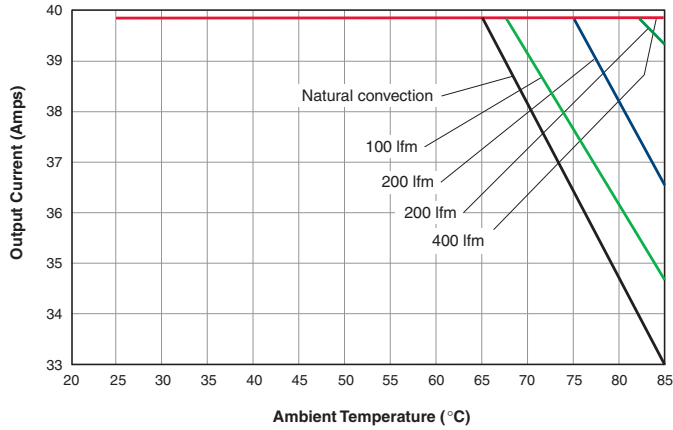

**UVQ-1.5/40-D24N: Maximum Current Temperature Derating**  
(With baseplate,  $V_{IN} = 24V$ , transverse air flow)

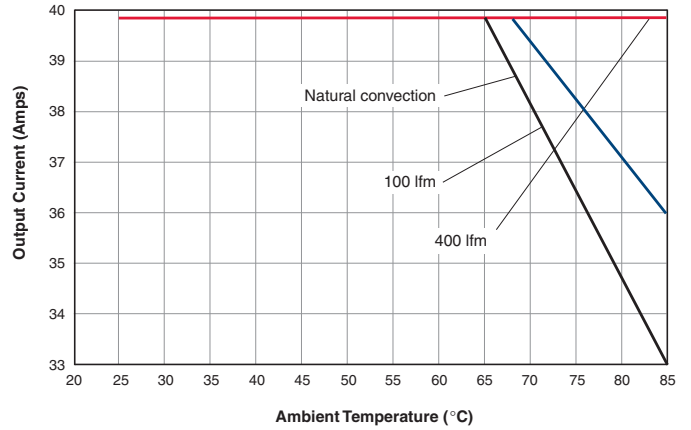

**UVQ-2.5/40-D48N**  
Efficiency vs. Line Voltage and Load Current @ 25°C

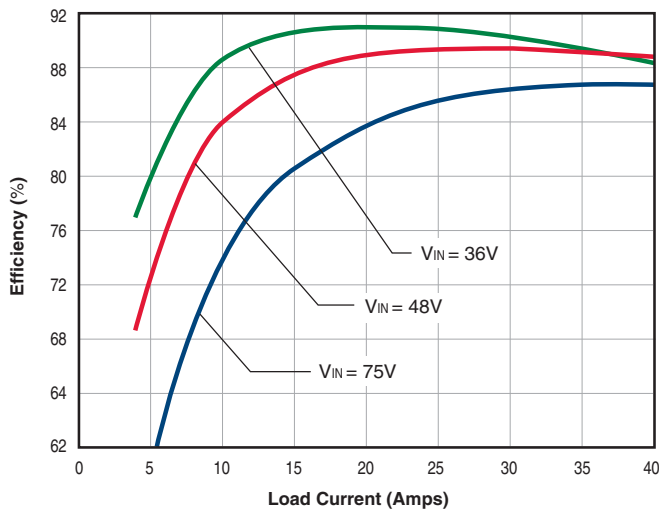

**UVQ-2.5/40-D48**  
Power Dissipation vs. Load Current @ 25°C

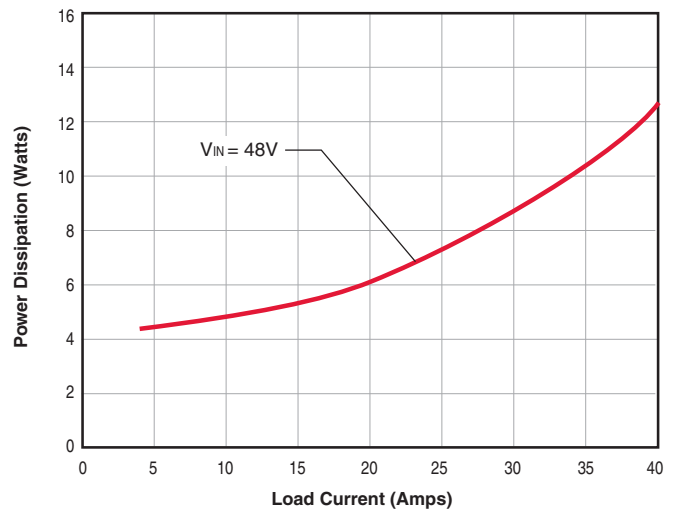

**UVQ-3.3/30-D24N: Maximum Current Temperature Derating**  
(No baseplate,  $V_{IN} = 24V$ , transverse air flow at sea level)

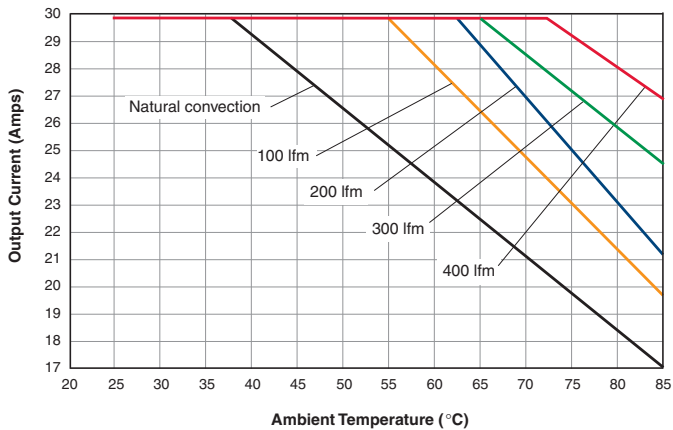

**UVQ-3.3/30-D24N: Maximum Current Temperature Derating**  
(With baseplate,  $V_{IN} = 24V$ , transverse air flow at sea level)

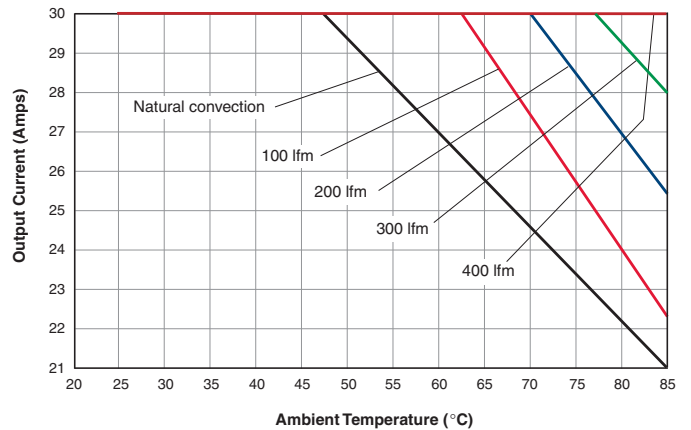

**TYPICAL PERFORMANCE DATA**

**UVQ-3.3/35-D48 Maximum Current Temperature Derating**  
(With baseplate,  $V_{IN} = 48V$ , transverse air flow at sea level)

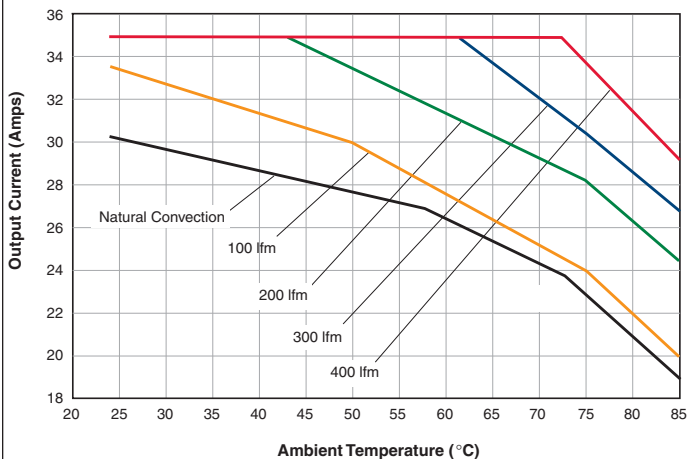

**UVQ-5/20-D24P Efficiency vs. Line Voltage and Load Current @ +25°C**

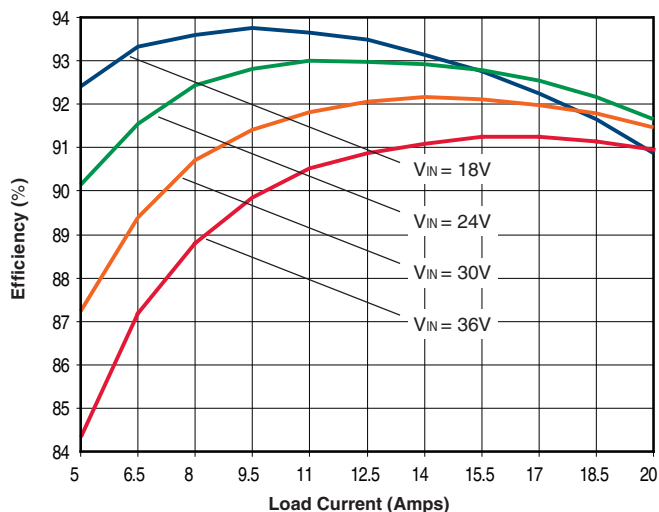

**UVQ-5/20-D24 Power Dissipation vs. Load Current @ +25°C**

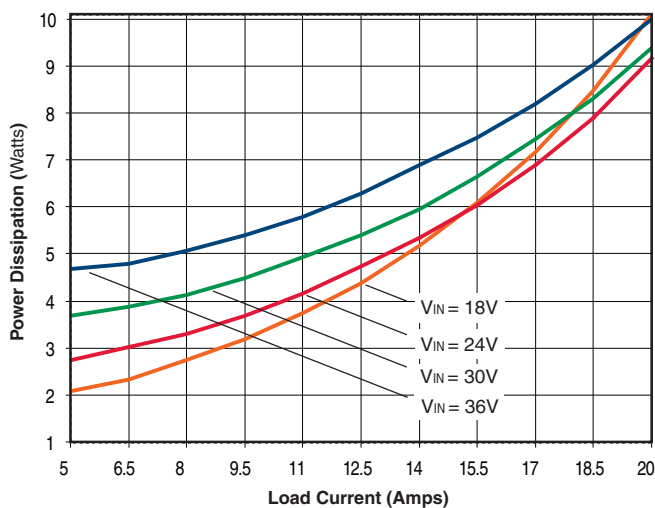

**UVQ-5/20-D24P: Maximum Current Temperature Derating**  
(No baseplate,  $V_{IN} = 24V$ , transverse air flow)

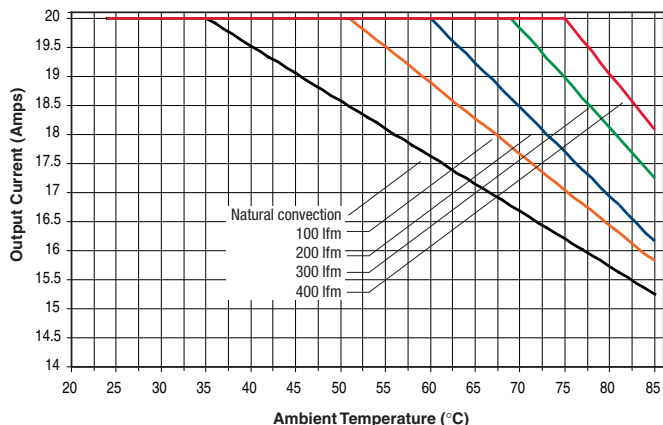

**UVQ-5/20-D24PB: Maximum Current Temperature Derating**  
(With baseplate,  $V_{IN} = 24V$ , transverse air flow)

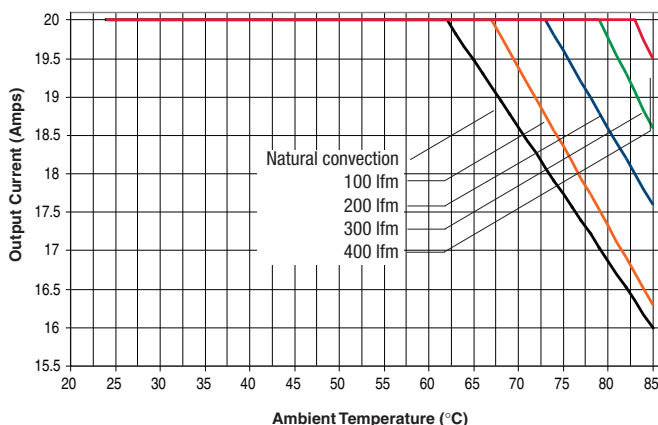

**TYPICAL PERFORMANCE DATA**

**UVQ-5/20-D48**  
Efficiency vs. Line Voltage and Load Current @ 25°C

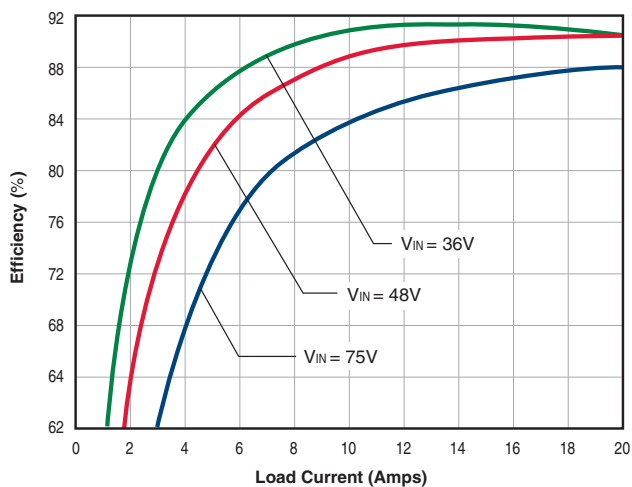

**UVQ-5/20-D48P: Maximum Current Temperature Derating**  
(No baseplate, VIN = 48V, transverse air flow at sea level)

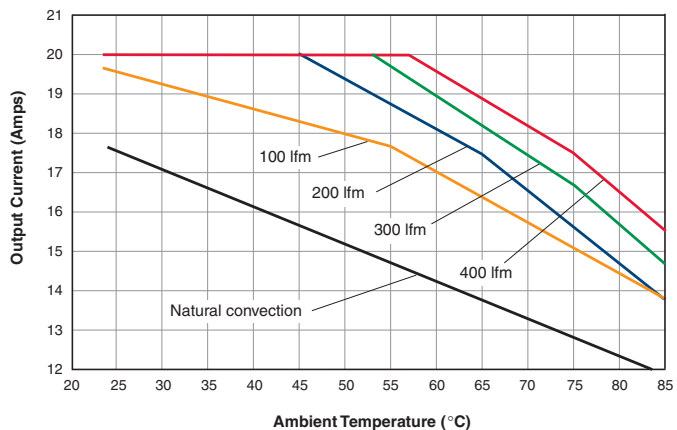

**UVQ-5/20-D48PB: Maximum Current Temperature Derating**  
(With baseplate, VIN = 48V, transverse air flow at sea level)

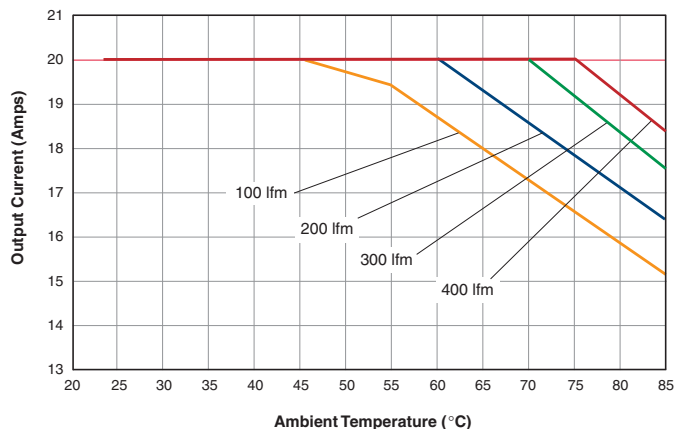

**UVQ-12/8-D24P**  
Efficiency vs. Line Voltage and Load Current @ +25°C

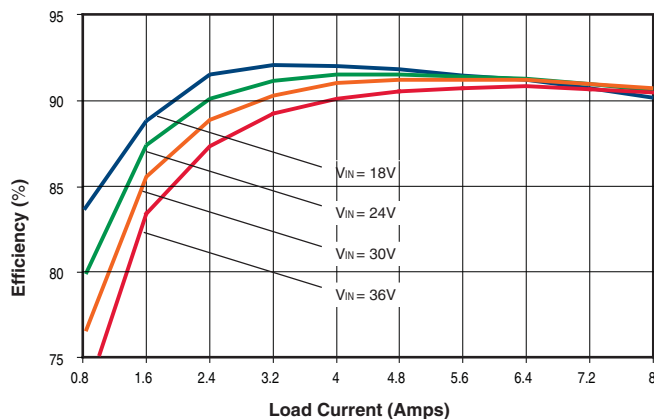

**UVQ-12/8-D24P: Maximum Current Temperature Derating**  
(No baseplate, VIN = 24V, transverse air flow)

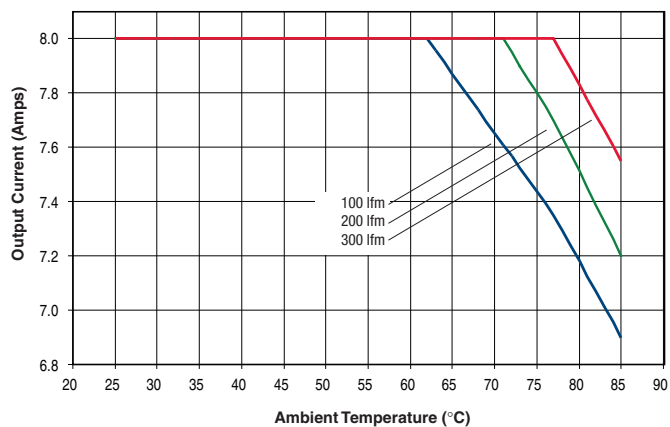

**UVQ-12/10-D48N**  
Efficiency vs. Line Voltage and Load Current @ +25°C

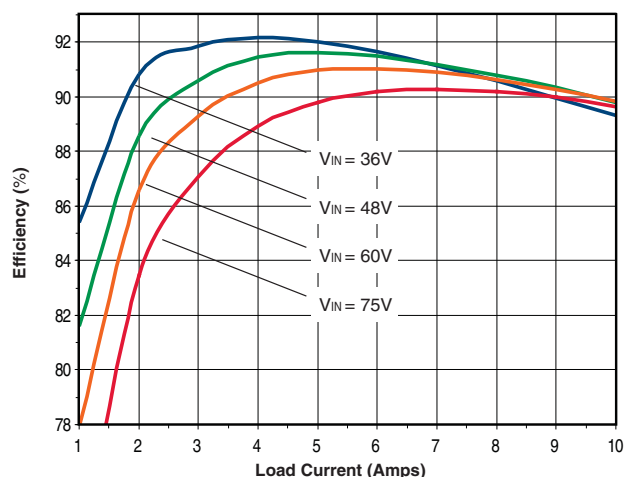

**TYPICAL PERFORMANCE DATA**

**UVQ-12/10-D48N**  
Power Dissipation vs. Load Current @ +25°C

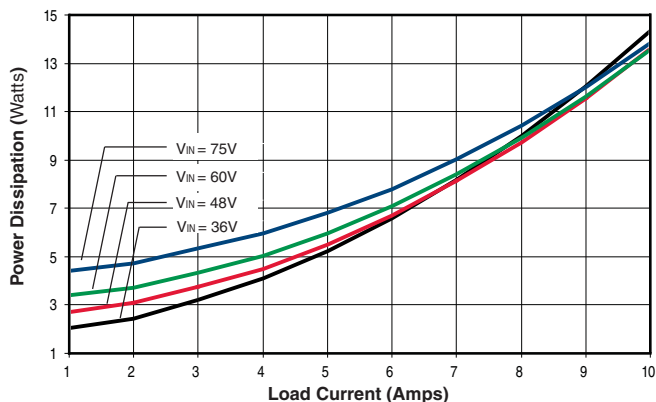

**UVQ-12/10-D48N: Maximum Current Temperature Derating**  
(No baseplate,  $V_{IN} = 48V$ , transverse air flow)

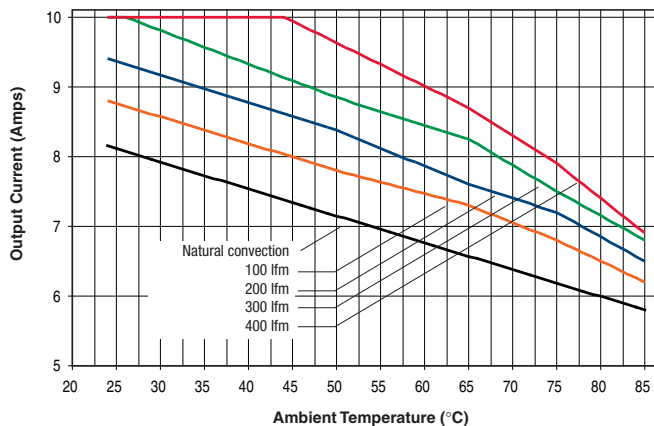

**UVQ-12/10-D48N: Maximum Current Temperature Derating**  
(With baseplate,  $V_{IN} = 48V$ , transverse air flow)

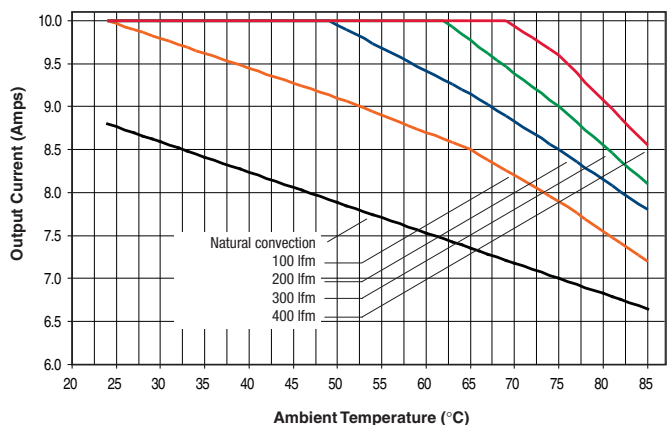

**UVQ-15/7-D24N**  
Efficiency vs. Line Voltage and Load Current @ +25°C

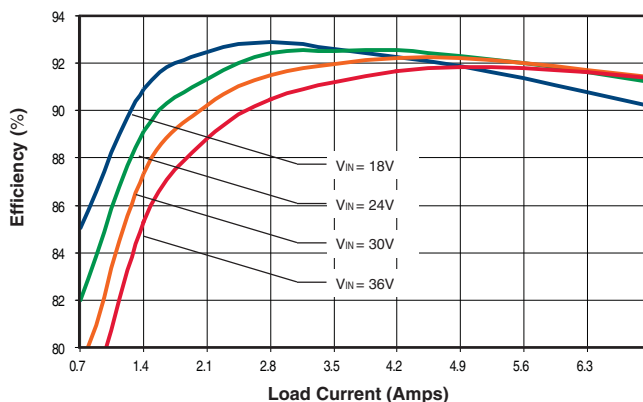

**UVQ-15/7-D24N**  
Power Dissipation vs. Load Current @ +25°C

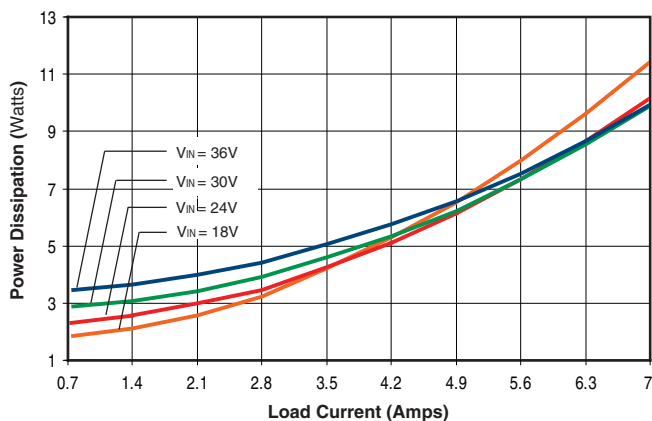

**UVQ-15/7-D24N: Maximum Current Temperature Derating**  
(No baseplate,  $V_{IN} = 24V$ , transverse air flow)

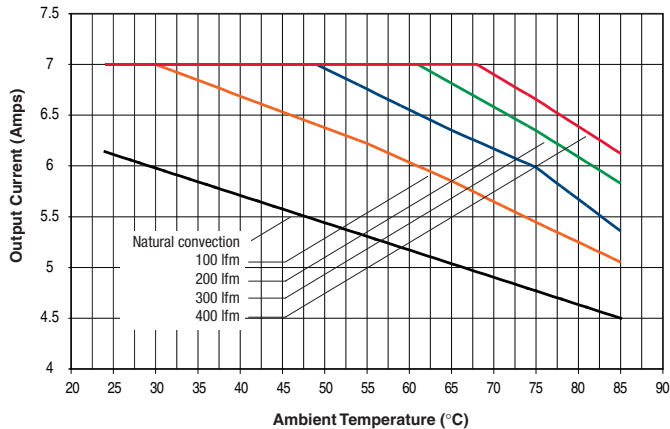

**TYPICAL PERFORMANCE DATA**

**UVQ-15/7-D24N: Maximum Current Temperature Derating**  
(With baseplate,  $V_{IN} = 24V$ , transverse air flow)

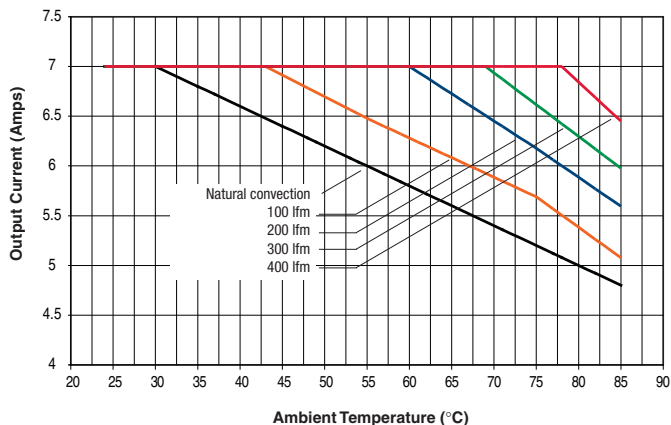

**UVQ-15/7-D48N Efficiency vs. Line Voltage and Load Current @ +25°C**

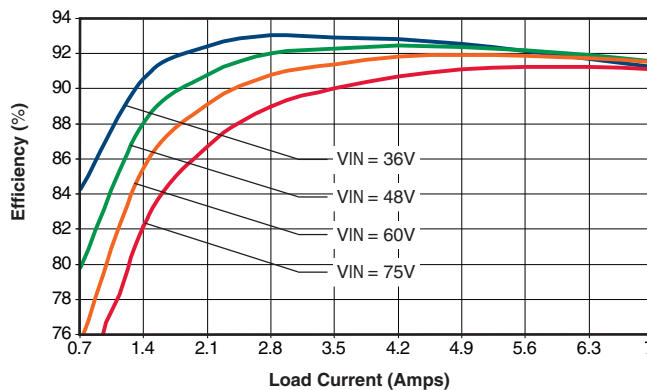

**UVQ-15/7-D48N Power Dissipation vs. Load Current @ +25°C**

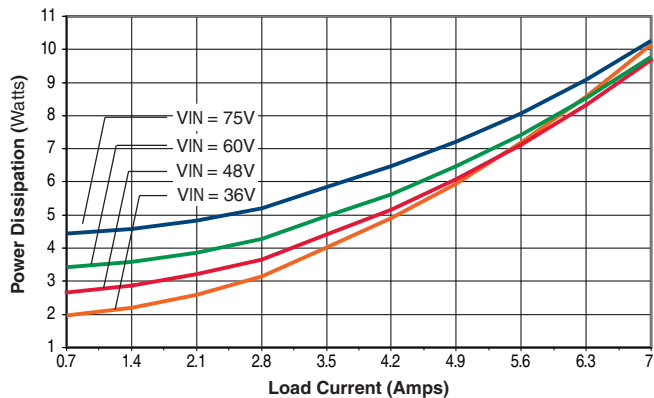

**UVQ-15/7-D48N: Maximum Current Temperature Derating**  
(No baseplate,  $V_{IN} = 48V$ , transverse air flow)

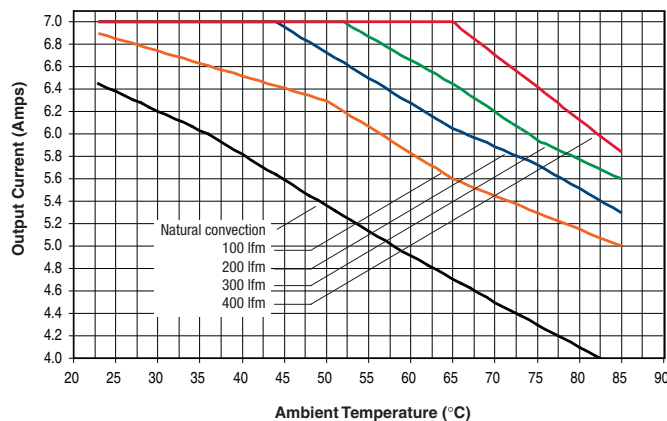

**UVQ-15/7-D48N: Maximum Current Temperature Derating**  
(With baseplate,  $V_{IN} = 48V$ , transverse air flow)

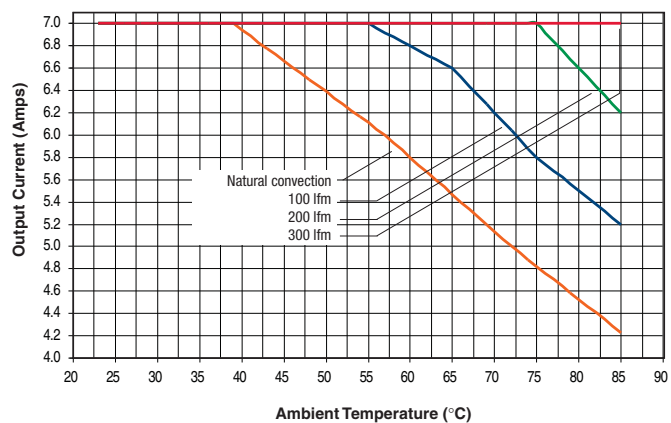

**UVQ-18/5.6-D24 Efficiency vs. Line Voltage and Load Current @ 25°C**

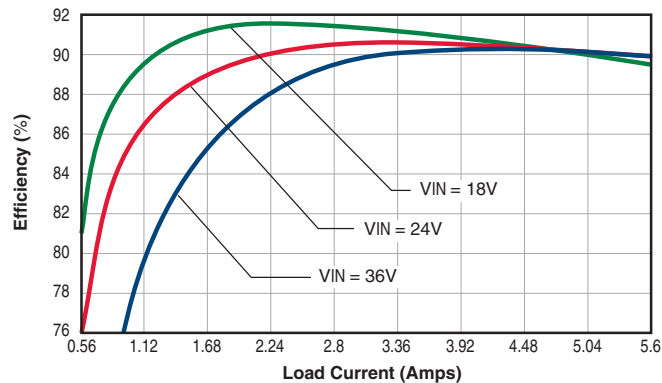

**TYPICAL PERFORMANCE DATA**

**UVQ-18/5.6-D24: Maximum Current Temperature Derating**  
(No baseplate,  $V_{IN} = 24V$ , transverse air flow)

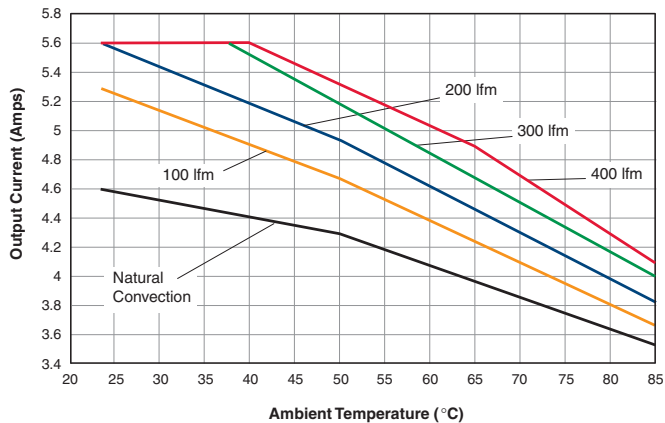

**UVQ-18/5.6-D24: Maximum Current Temperature Derating**  
(With baseplate,  $V_{IN} = 24V$ , transverse air flow)

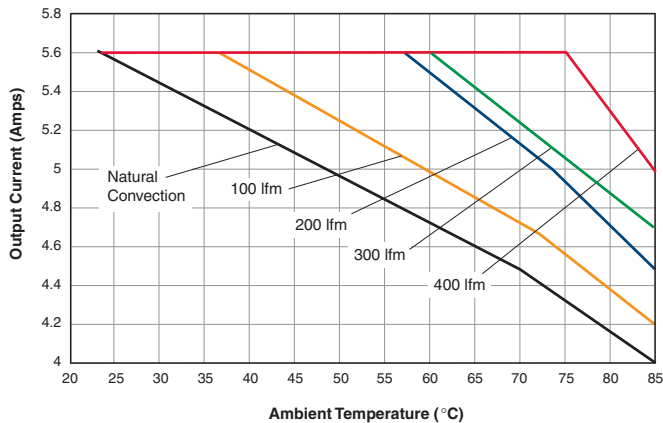

**UVQ-18/6-D48N**  
Efficiency vs. Line Voltage and Load Current @ 25°C

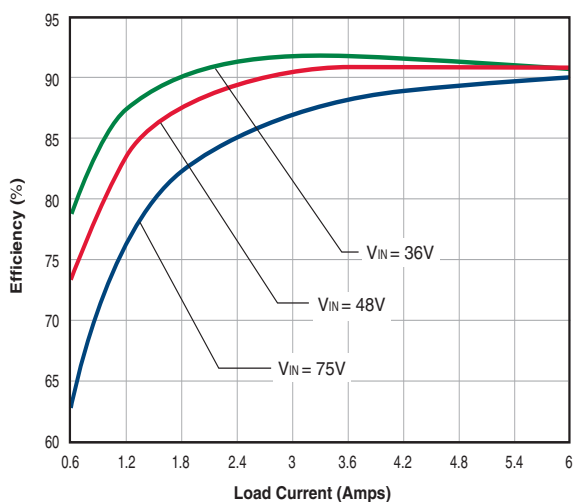

**UVQ-18/6-D48**  
Power Dissipation vs. Load Current @ 25°C

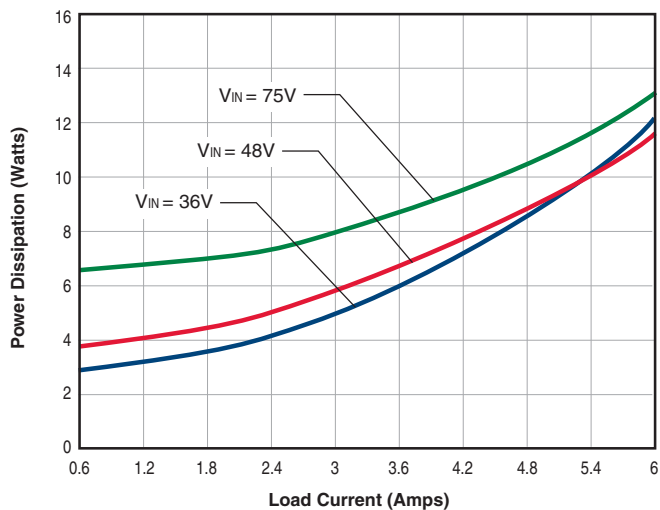

**UVQ-18/6-D48: Maximum Current Temperature Derating**  
(No baseplate,  $V_{IN} = 48V$ , transverse air flow)

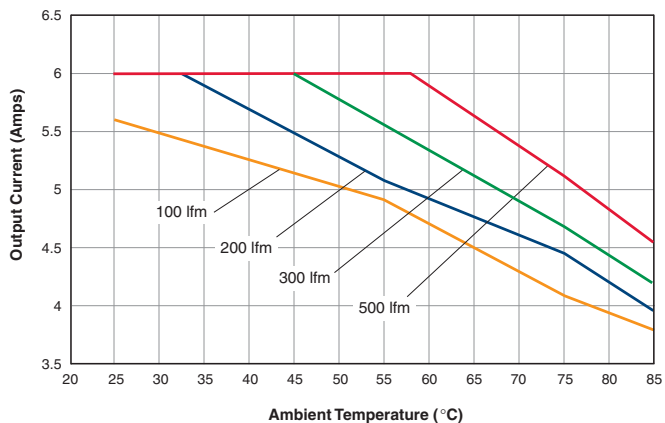

**UVQ-18/6-D48: Maximum Current Temperature Derating**  
(With baseplate,  $V_{IN} = 48V$ , transverse air flow)

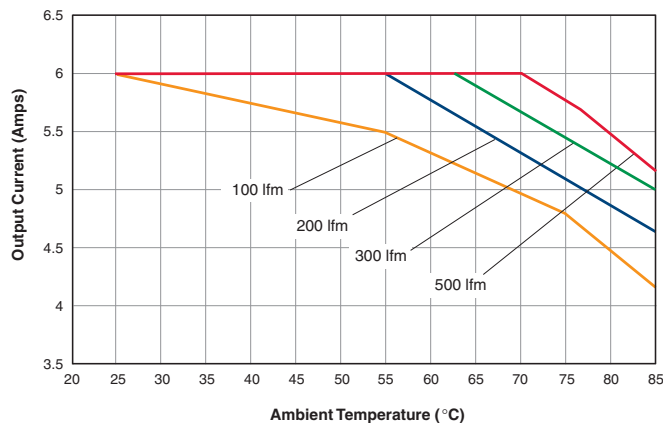

**TYPICAL PERFORMANCE DATA**

**UVQ-24/4.5-D24N**  
Efficiency vs. Line Voltage and Load Current @ +25°C

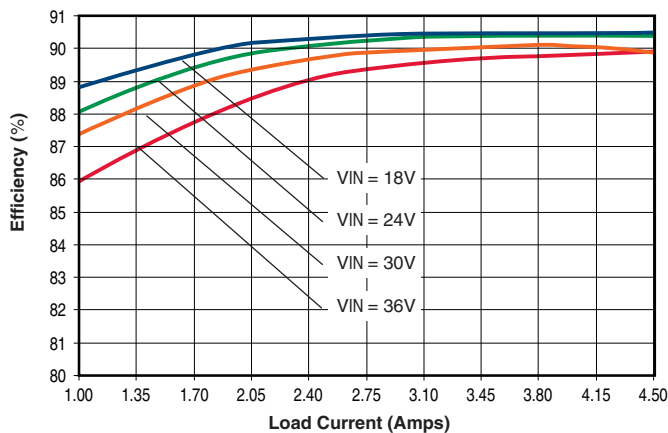

**UVQ-24/4.5-D24P: Maximum Current Temperature Derating**  
(No baseplate,  $V_{IN} = 24V$ , air flow is from Pin 1 to Pin 3)

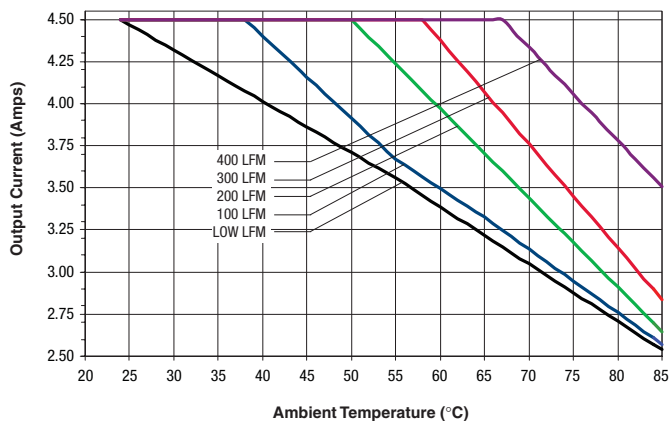

**UVQ-24/4.5-D24P: Maximum Current Temperature Derating**  
(With baseplate,  $V_{IN} = 24V$ , air flow is from Pin 1 to Pin 3)

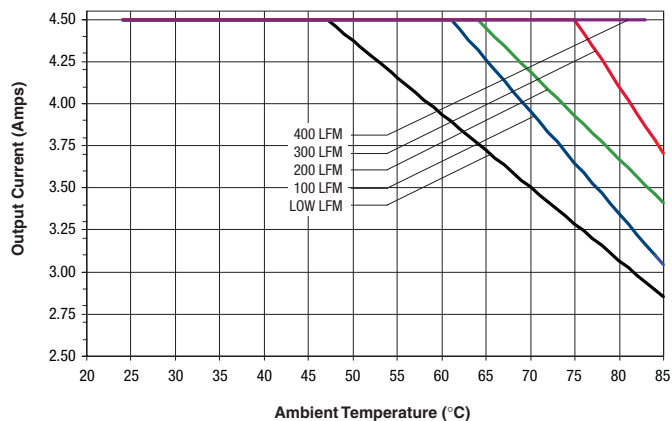

**UVQ-24/4.5-D48N**  
Efficiency vs. Line Voltage and Load Current @ +25°C

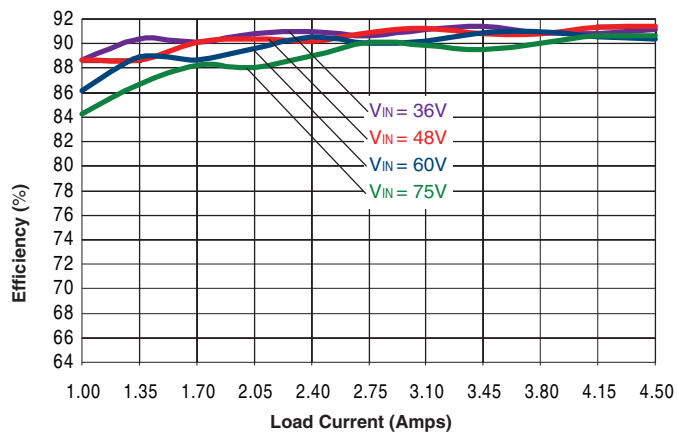

**UVQ-24/4.5-D48N: Maximum Current Temperature Derating**  
(No baseplate,  $V_{IN} = 48V$ , transverse air flow)

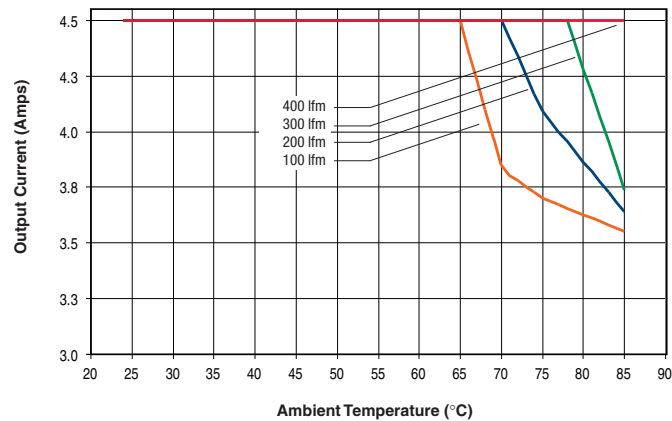



**TYPICAL PERFORMANCE DATA**

**UVQ-48/2.5-D48N**  
Efficiency vs. Line Voltage and Load Current @ 25°C

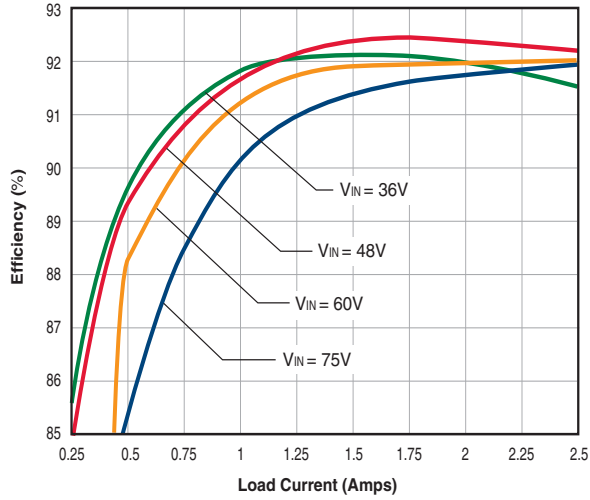

**UVQ-48/2.5-D48N: Maximum Current Temperature Derating**  
(With baseplate,  $V_{IN} = 48V$ , transverse air flow)

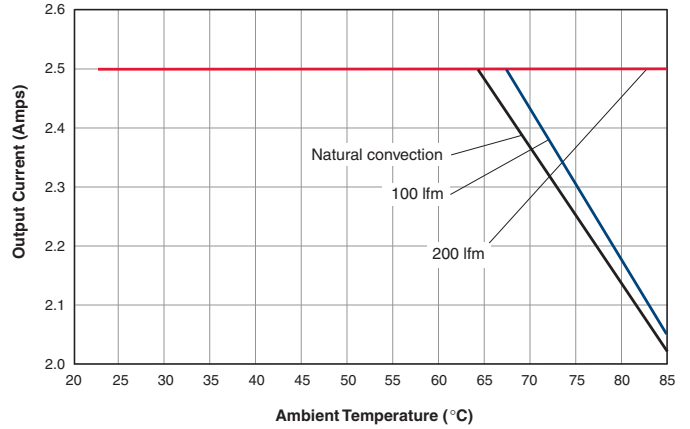

**MECHANICAL SPECIFICATIONS**

**Case C59**

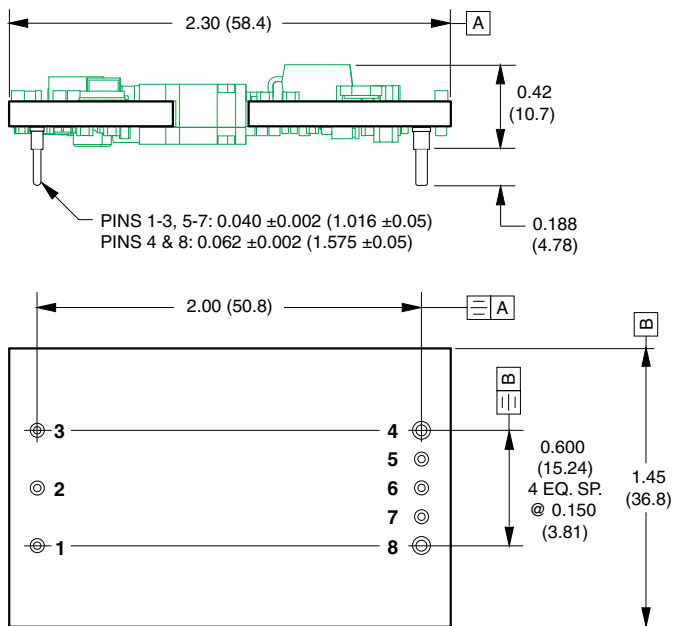

**BOTTOM VIEW**  
Alternate pin lengths are available. Contact Murata Power Solutions.

**Case C59 with Baseplate**

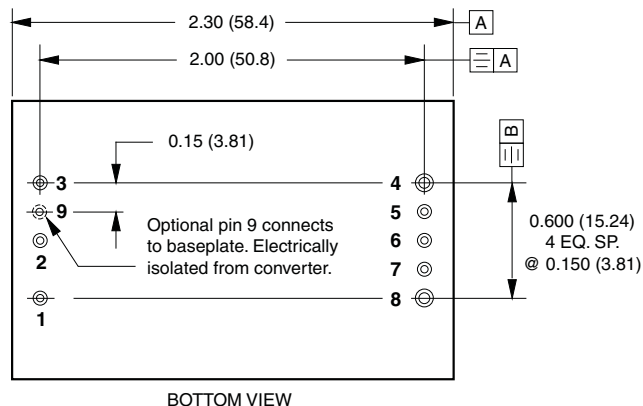
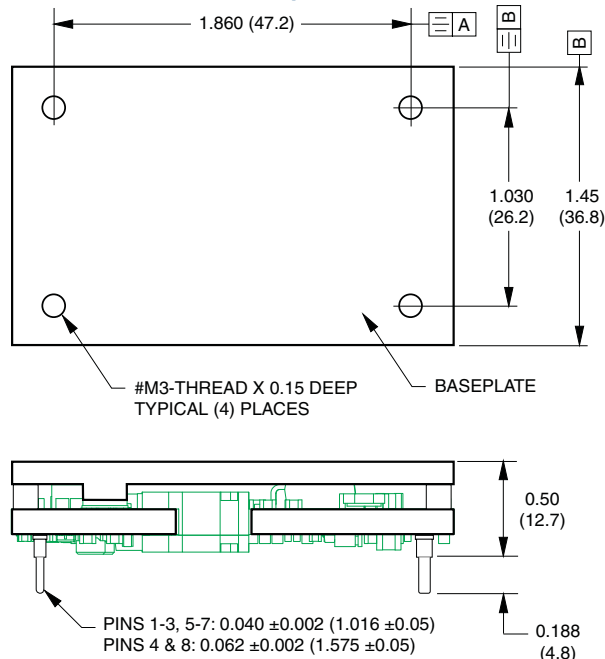

**BOTTOM VIEW**

Optional baseplate pin is special order. Contact Murata Power Solutions..

Dimensions are in inches (mm shown for ref. only).

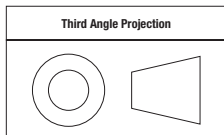

Tolerances (unless otherwise specified):  
.XX ± 0.02 (0.5)  
.XXX ± 0.010 (0.25)  
Angles ± 2°

Components are shown for reference only.

| DOSA-Compliant I/O Connections |                |
|--------------------------------|----------------|
| Pin                            | Function P32   |
| 1                              | +Vin           |
| 2                              | On/Off Control |
| 3                              | -Vin           |
| 4                              | -Vout          |
| 5                              | -Sense         |
| 6                              | Trim           |
| 7                              | +Sense         |
| 8                              | +Vout          |

Important: If sense inputs are not connected to a remote load, connect them to their respective Vout pins at the converter.

**ABSOLUTE MAXIMUM RATINGS**

|                                   |  |                   |
|-----------------------------------|--|-------------------|
| Input Voltage                     | <u>24V models</u>  | <u>48V models</u> |
| Continuous                        | 0 to +36V  | 0 to +75V         |
| Transient (100 mS)                | +50V   | +100V             |
| On/Off Control                    | −0.3 V min to +13.5V max.  |                   |
| Input Reverse Polarity Protection | See Fuse section   |                   |
| Output Overvoltage                | V <sub>OUT</sub> +20% max.   |                   |
| Output Current (Note 7)           | Current-limited. Devices can withstand sustained short circuit without damage. |                   |
| Storage Temperature               | −55 to +125°C  |                   |
| Lead Temperature                  | See soldering guidelines   |                   |

Absolute maximums are stress ratings. Exposure of devices to greater than any of these conditions may adversely affect long-term reliability. Proper operation under conditions other than those listed in the Performance/Functional Specifications Table is not implied nor recommended.

- (1) All models are tested and specified with 200 LFM airflow, external 1||10μF ceramic/tantalum output capacitors. External input capacitance varies according to model type. All capacitors are low ESR types. These capacitors are necessary to accommodate our test equipment and may not be required to achieve specified performance in your applications. All models are stable and regulate within spec under no-load conditions. General conditions for Specifications are +25°C, V<sub>IN</sub> = nominal, V<sub>OUT</sub> = nominal, full load.
- (2) Input Ripple Current is tested and specified over a 5-20MHz bandwidth. Input filtering is C<sub>IN</sub> = 33μF tantalum, C<sub>BUS</sub> = 220μF electrolytic, L<sub>BUS</sub> = 12μH.
- (3) Note that Maximum Power Derating curves indicate an average current at nominal input voltage. At higher temperatures and/or lower airflow, the DC-DC converter will tolerate brief full current outputs if the total RMS current over time does not exceed the Derating curve.
- (4) Mean Time Before Failure is calculated using the Telcordia (Belcore) SR-332 Method 1, Case 3, ground fixed conditions, TPCBOARD = +25°C, full output load, natural air convection.
- (5) The On/Off Control may be driven with external logic or by applying appropriate external voltages which are referenced to Input Common. The On/Off Control Input should use either an open collector/open drain transistor or logic gate which does not exceed +13.5V.
- (6) Short circuit shutdown begins when the output voltage degrades approximately 2% from the selected setting.
- (7) The outputs are not intended to sink appreciable reverse current.
- (8) Output noise may be further reduced by adding an external filter. See I/O Filtering and Noise Reduction.
- (9) All models are fully operational and meet published specifications, including “cold start” at −40°C.
- (10) Regulation specifications describe the deviation as the line input voltage or output load current is varied from a nominal midpoint value to either extreme.
- (11) Overvoltage shutdown on 48V input models is not supplied in order to comply with telecom reliability requirements. These requirements attempt continued operation despite significant input overvoltage.
- (12) Do not exceed maximum power specifications when adjusting the output trim.
- (13) Note that the converter may operate up to +110°C with the baseplate installed. However, thermal self-protection occurs near +110°C, and there is a temperature gradient between the hotspot and the baseplate. Therefore, +100°C is recommended to avoid thermal shutdown.
- (14) The converter is guaranteed to turn off at the UV shutdown voltage.
- (15) At full power, the package temperature of all on-board components must not exceed +128°C.

**TECHNICAL NOTES**

**Removal of Soldered UVQs from Printed Circuit Boards**

Should removal of the UVQ from its soldered connection be needed, thoroughly de-solder the pins using solder wicks or de-soldering tools. At no time should any prying or leverage be used to remove boards that have not been properly de-soldered first.

**Input Source Impedance**

UVQ converters must be driven from a low ac-impedance input source. The DC-DC's performance and stability can be compromised by the use of highly inductive source impedances. The input circuit shown in Figure 2 is a practical solution that can be used to minimize the effects of inductance in the input traces. For optimum performance, components should be mounted close to the DC-DC converter.

**I/O Filtering, Input Ripple Current, and Output Noise**

All models in the UVQ Series are tested/specified for input ripple current (also called input reflected ripple current) and output noise using the circuits and layout shown in Figures 2 and 3.

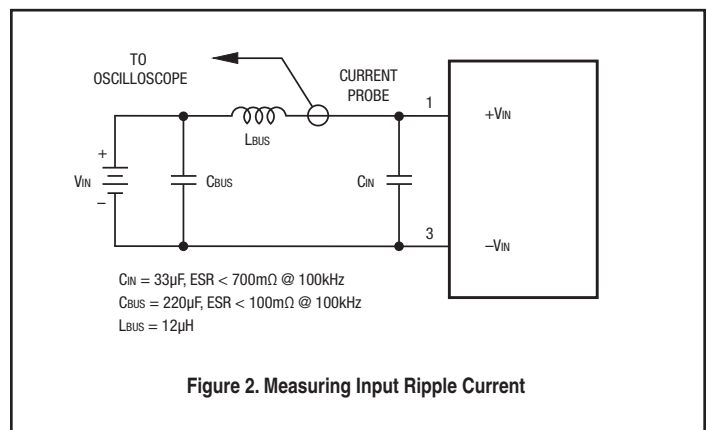

**Figure 2. Measuring Input Ripple Current**

External input capacitors (C<sub>IN</sub> in Figure 2) serve primarily as energy-storage elements. They should be selected for bulk capacitance (at appropriate frequencies), low ESR, and high rms-ripple-current ratings. The switching nature of DC-DC converters requires that dc voltage sources have low ac impedance as highly inductive source impedance can affect system stability. In Figure 2, C<sub>BUS</sub> and L<sub>BUS</sub> simulate a typical dc voltage bus. Your specific system configuration may necessitate additional considerations.

In critical applications, output ripple/noise (also referred to as periodic and random deviations or PARD) can be reduced below specified limits using filtering techniques, the simplest of which is the installation of additional external output capacitors. Output capacitors function as true filter elements and should be selected for bulk capacitance, low ESR, and appropriate frequency response.

All external capacitors should have appropriate voltage ratings and be located as close to the converter as possible. Temperature variations for all relevant parameters should be taken into consideration. OS-CON™ organic semiconductor capacitors (www.sanyo.com) can be especially effective for further reduction of ripple/noise. The most effective combination of external I/O capacitors will be a function of line voltage and source impedance, as well as particular load and layout conditions.

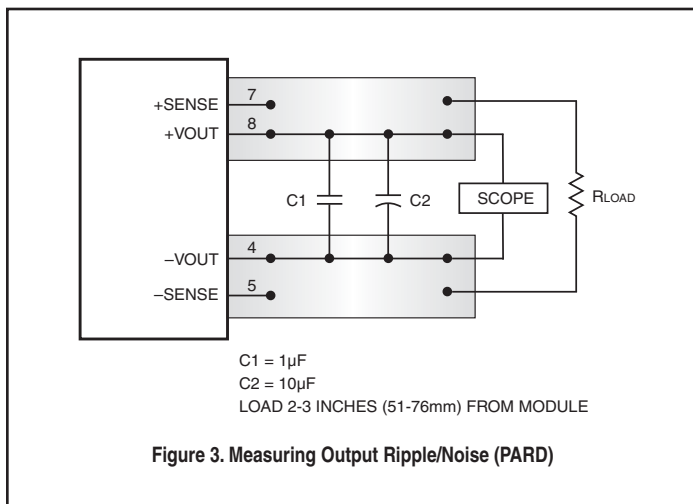

Figure 3. Measuring Output Ripple/Noise (PARD)

### Start-Up Threshold and Undervoltage Shutdown

Under normal start-up conditions, the UVQ Series will not begin to regulate properly until the ramping input voltage exceeds the Start-Up Threshold. Once operating, devices will turn off when the applied voltage drops below the Undervoltage Shutdown point. Devices will remain off as long as the undervoltage condition continues. Units will automatically re-start when the applied voltage is brought back above the Start-Up Threshold. The hysteresis built into this function avoids an indeterminate on/off condition at a single input voltage. See Performance/Functional Specifications table for actual limits.

### Start-Up Time

The  $V_{IN}$  to  $V_{OUT}$  Start-Up Time is the interval between the point at which a ramping input voltage crosses the Start-Up Threshold voltage and the point at which the fully loaded output voltage enters and remains within its specified  $\pm 1\%$  accuracy band. Actual measured times will vary with input source impedance, external input capacitance, and the slew rate and final value of the input voltage as it appears to the converter. The On/Off to  $V_{OUT}$  start-up time assumes that the converter is turned off via the Remote On/Off Control with the nominal input voltage already applied.

### On/Off Control

The primary-side, Remote On/Off Control function (pin 2) can be specified to operate with either positive or negative logic. Positive-logic devices ("P" suffix) are enabled when pin 2 is left open or is pulled high. Positive-logic devices are disabled when pin 2 is pulled low. Negative-logic devices are off when pin 2 is high/open and on when pin 2 is pulled low. See Figure 4.

Dynamic control of the remote on/off function is best accomplished with a mechanical relay or an open-collector/open-drain drive circuit (optically isolated if appropriate). The drive circuit should be able to sink appropriate current (see Performance Specifications) when activated and withstand appropriate voltage when deactivated.

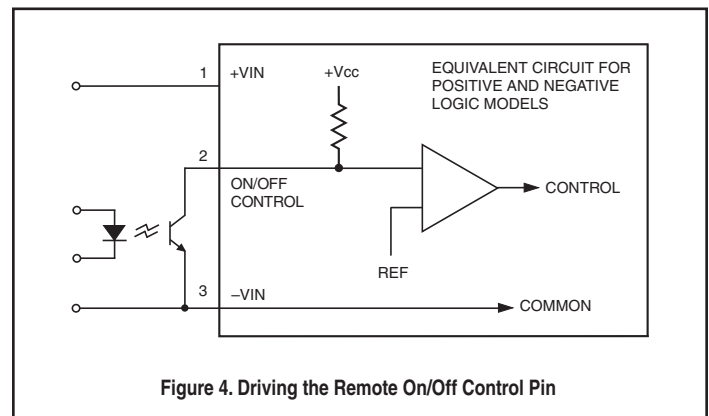

Figure 4. Driving the Remote On/Off Control Pin

### Current Limiting (Power limit with current mode control)

As power demand increases on the output and enters the specified "limit inception range" (current in voltage mode and power in current mode) limiting circuitry activates in the DC-DC converter to limit/restrict the maximum current or total power available. In voltage mode, current limit can have a "constant or foldback" characteristic. In current mode, once the current reaches a certain range the output voltage will start to decrease while the output current continues to increase, thereby maintaining constant power, until a maximum peak current is reached and the converter enters a "hic-up" (on off cycling) mode of operation until the load is reduced below the threshold level, whereupon it will return to a normal mode of operation. Current limit inception is defined as the point where the output voltage has decreased by a pre-specified percentage (usually a 2% decrease from nominal).

### Short Circuit Condition (Current mode control)

The short circuit condition is an extension of the "Current Limiting" condition. When the monitored peak current signal reaches a certain range, the PWM controller's outputs are shut off thereby turning the converter "off." This is followed by an extended time out period. This period can vary depending on other conditions such as the input voltage level. Following this time out period, the PWM controller will attempt to re-start the converter by initiating a "normal start cycle" which includes softstart. If the "fault condition" persists, another "hic-up" cycle is initiated. This "cycle" can and will continue indefinitely until such time as the "fault condition" is removed, at which time the converter will resume "normal operation." Operating in the "hic-up" mode during a fault condition is advantageous in that average input and output power levels are held low preventing excessive internal increases in temperature.

**Thermal Shutdown**

UVQ converters are equipped with thermal-shutdown circuitry. If the internal temperature of the DC-DC converter rises above the designed operating temperature (See Performance Specifications), a precision temperature sensor will power down the unit. When the internal temperature decreases below the threshold of the temperature sensor, the unit will self start.

**Output Overvoltage Protection**

The output voltage is monitored for an overvoltage condition via magnetic coupling to the primary side. If the output voltage rises to a fault condition, which could be damaging to the load circuitry (see Performance Specifications), the sensing circuitry will power down the PWM controller causing the output voltage to decrease. Following a time-out period the PWM will restart, causing the output voltage to ramp to its appropriate value. If the fault condition persists, and the output voltages again climb to excessive levels, the overvoltage circuitry will initiate another shutdown cycle. This on/off cycling is referred to as "hiccup" mode.

**Input Reverse-Polarity Protection**

If the input-voltage polarity is accidentally reversed, an internal diode will become forward biased and likely draw excessive current from the power source. If the source is not current limited or the circuit appropriately fused, it could cause permanent damage to the converter.

**Input Fusing**

Certain applications and/or safety agencies may require the installation of fuses at the inputs of power conversion components. Fuses should also be used if the possibility of a sustained, non-current-limited, input-voltage polarity reversal exists. For Murata Power Solutions' UVQ Series DC-DC Converters, fast-blow fuses are recommended with values no greater than twice the maximum input current.

**Trimming Output Voltage**

UVQ converters have a trim capability (pin 6) that enables users to adjust the output voltage from +10% to -20% (refer to the trim equations). Adjustments to the output voltage can be accomplished with a single fixed resistor as shown in Figures 5 and 6. A single fixed resistor can increase or decrease the output voltage depending on its connection. Resistors should be located close to the converter and have TCR's less than 100ppm/°C to minimize sensitivity to changes in temperature. If the trim function is not used, leave the trim pin open.

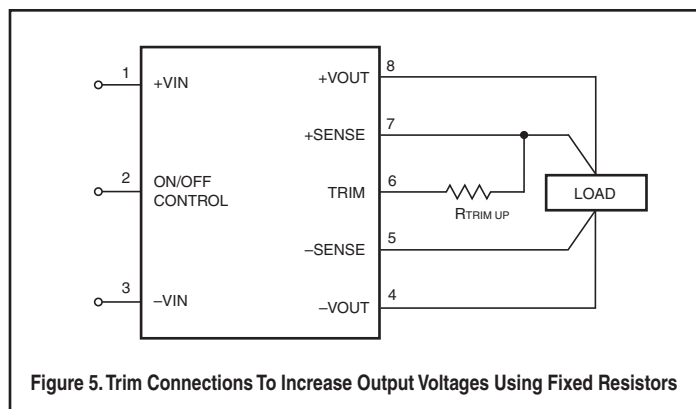

Figure 5. Trim Connections To Increase Output Voltages Using Fixed Resistors

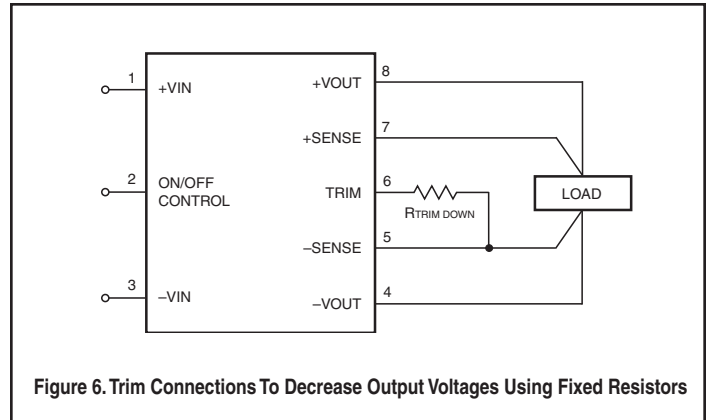

Figure 6. Trim Connections To Decrease Output Voltages Using Fixed Resistors

On UVQs, a single resistor connected from the Trim pin (pin 6) to the +Sense (pin 7) will increase the output voltage. A resistor connected from the Trim Pin (pin 6) to the -Sense (pin 5) will decrease the output voltage.

Trim adjustments greater than the specified +10%/-20% can have an adverse affect on the converter's performance and are not recommended. Excessive voltage differences between V<sub>OUT</sub> and Sense, in conjunction with trim adjustment of the output voltage, can cause the overvoltage protection circuitry to activate (see Performance Specifications for overvoltage limits).

Temperature/power derating is based on maximum output current and voltage at the converter's output pins. Use of the trim and sense functions can cause output voltages to increase, thereby increasing output power beyond the UVQ's specified rating, or cause output voltages to climb into the output overvoltage region. Therefore:

$$(V_{out \text{ at pins}}) \times (I_{out}) \leq \text{rated output power}$$

The Trim pin (pin 6) is a relatively high impedance node that can be susceptible to noise pickup when connected to long conductors in noisy environments.

**Soldering Guidelines**

Murata Power Solutions recommends the specifications below when installing these converters. These specifications vary depending on the solder type. Exceeding these specifications may cause damage to the product. Your production environment may differ; therefore please thoroughly review these guidelines with your process engineers.

**Wave Solder Operations for through-hole mounted products (THMT)**

**For Sn/Ag/Cu based solders:**

|                             |           |
|-----------------------------|-----------|
| Maximum Preheat Temperature | 115° C.   |
| Maximum Pot Temperature     | 270° C.   |
| Maximum Solder Dwell Time   | 7 seconds |

**For Sn/Pb based solders:**

|                             |           |
|-----------------------------|-----------|
| Maximum Preheat Temperature | 105° C.   |
| Maximum Pot Temperature     | 250° C.   |
| Maximum Solder Dwell Time   | 6 seconds |

**Trim Equations**

Trim Up

Trim Down

| UVQ-1.5/40-D24  |  |
|---|--|
| $R_{TUP} (k\Omega) = \frac{6.23(V_O - 1.226)}{V_O - 1.5} - 10.2$  | $R_{TDOWN} (k\Omega) = \frac{7.64}{1.5 - V_O} - 10.2$  |
| UVQ-2.5/40-D48, UVQ-2.5/35-D24                                    |  |
| $R_{TUP} (k\Omega) = \frac{10(V_O - 1.226)}{V_O - 2.5} - 10.2$    | $R_{TDOWN} (k\Omega) = \frac{12.26}{2.5 - V_O} - 10.2$ |
| UVQ-3.3/35-D48  |  |
| $R_{TUP} (k\Omega) = \frac{13.3(V_O - 1.226)}{V_O - 3.3} - 10.2$  | $R_{TDOWN} (k\Omega) = \frac{16.31}{3.3 - V_O} - 10.2$ |
| UVQ-5/25-D24, UVQ-5/20-D48  |  |
| $R_{TUP} (k\Omega) = \frac{20.4(V_O - 1.226)}{V_O - 5} - 10.2$    | $R_{TDOWN} (k\Omega) = \frac{25.01}{5 - V_O} - 10.2$   |
| UVQ-12/8-D24, -12/10-D48  |  |
| $R_{TUP} (k\Omega) = \frac{49.6(V_O - 1.226)}{V_O - 12} - 10.2$   | $R_{TDOWN} (k\Omega) = \frac{60.45}{12 - V_O} - 10.2$  |
| UVQ-15/7-D24, -D48  |  |
| $R_{TUP} (k\Omega) = \frac{62.9(V_O - 1.226)}{V_O - 15} - 10.2$   | $R_{TDOWN} (k\Omega) = \frac{76.56}{15 - V_O} - 10.2$  |
| UVQ-18/5.6-D24, -18/6-D48   |  |
| $R_{TUP} (k\Omega) = \frac{75.5(V_O - 1.226)}{V_O - 18} - 10.2$   | $R_{TDOWN} (k\Omega) = \frac{92.9}{18 - V_O} - 10.2$   |
| UVQ-24/4.5-D24, -D48  |  |
| $R_{TUP} (k\Omega) = \frac{101(V_O - 1.226)}{V_O - 24} - 10.2$    | $R_{TDOWN} (k\Omega) = \frac{124.2}{24 - V_O} - 10.2$  |
| UVQ-48/2.5-D24, -D48  |  |
| $R_{TUP} (k\Omega) = \frac{210.75(V_O - 1.226)}{V_O - 48} - 10.2$ | $R_{TDOWN} (k\Omega) = \frac{250}{48 - V_O} - 10.2$    |

**Note:** Higher output 24V and 48V converters require larger, low-tempco, precision trim resistors. An alternative is a low-TC multi-turn potentiometer (20kΩ typical) connected between +V<sub>OUT</sub> and -V<sub>OUT</sub> with the wiper to the Trim pin.

**FEATURES AND OPTIONS**

**Remote Sense**

Note: The Sense and V<sub>OUT</sub> lines are internally connected through low-value resistors. Nevertheless, if the sense function is not used for remote regulation the user must connect the +Sense to +V<sub>OUT</sub> and -Sense to -V<sub>OUT</sub> at the DC-DC converter pins.

UVQ series converters employ a sense feature to provide point of use regulation, thereby overcoming moderate IR drops in pcb conductors or cabling. The remote sense lines carry very little current and therefore require minimal cross-sectional-area conductors. The sense lines, which are capacitively coupled to their respective output lines, are used by the feedback control-loop to regulate the output. As such, they are not low impedance points and must be treated with care in layouts and cabling. Sense lines on a pcb should be run adjacent to dc signals, preferably ground. In cables and discrete wiring applications, twisted pair or other techniques should be implemented.

UVQ series converters will compensate for drops between the output voltage at the DC-DC and the sense voltage at the DC-DC provided that:

$$[V_{out(+)} - V_{out(-)}] - [Sense(+) - Sense(-)] \leq 10\% V_{out}$$

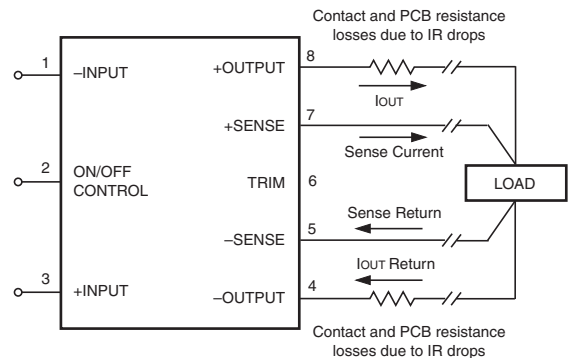

**Figure 8. Remote Sense Circuit Configuration**

Output overvoltage protection is monitored at the output voltage pin, not the Sense pin. Therefore, excessive voltage differences between V<sub>OUT</sub> and Sense in conjunction with trim adjustment of the output voltage can cause the overvoltage protection circuitry to activate (see Performance Specifications for overvoltage limits). Power derating is based on maximum output current and voltage at the converter's output pins. Use of trim and sense functions can cause output voltages to increase, thereby increasing output power beyond the converter's specified rating, or cause output voltages to climb into the output overvoltage region. Therefore, the designer must ensure:

$$(V_{out \text{ at pins}}) \times (I_{out}) \leq \text{rated output power}$$

**UVQ Series Aluminum Heatsink**

The UVQ series converter baseplate can be attached either to an enclosure wall or a heatsink to remove heat from internal power dissipation. The discussion below concerns only the heatsink alternative. The UVQs are available with a low-profile extruded aluminum heatsink kit, models HS-QB25-UVQ, HS-QB50-UVQ, and HS-QB100-UVQ. This kit includes the heatsink, thermal mounting pad, screws and mounting hardware. See the assembly diagram below. Do not overtighten the screws in the tapped holes in the converter (3.5 n-m or 1.9 in-oz. max.). This kit adds excellent thermal performance without sacrificing too much component height. See the Mechanical Outline Drawings for assembled dimensions. If the thermal pad is firmly attached, no thermal compound (“thermal grease”) is required.

**Thermal Performance**

The HS-QB25-UVQ heatsink has a thermal resistance of 12 °C/Watt of internal heat dissipation with “natural convection” airflow (no fans or other mechanical airflow) at sea level altitude. This thermal resistance assumes that the heatsink is firmly attached using the supplied thermal pad and that there is no nearby wall or enclosure surface to inhibit the airflow. The thermal pad adds a negligible series resistance of approximately 0.5°C/Watt so that the total assembled resistance is 12.5°C/Watt.

Be aware that we need to handle only the internal heat dissipation, not the full power output of the converter. This internal heat dissipation is related to the efficiency as follows:

$$\text{Power Dissipation [Pd]} = \text{Power In} - \text{Power Out} \quad [1]$$

$$\text{Power Out} / \text{Power In} = \text{Efficiency [in \%]} / 100 \quad [2]$$

$$\text{Power Dissipation [Pd]} = \text{Power In} \times (1 - \text{Efficiency\%/100}) \quad [3]$$

$$\text{Power Dissipation [Pd]} = \text{Power Out} \times (1 / (\text{Efficiency\%/100}) - 1) \quad [4]$$

Efficiency of course varies with input voltage and the total output power. Please refer to the Performance Curves.

Since many applications do include fans, here is an approximate equation to calculate the net thermal resistance:

$$R_{\Theta} [\text{at airflow}] = R_{\Theta} [\text{natural convection}] / (1 + (\text{Airflow in LFM}) \times [\text{Airflow Constant}]) \quad [5]$$

Where,

$R_{\Theta}$  [at airflow] is the net thermal resistance (in °C/W) with the amount of airflow available and,

$R_{\Theta}$  [natural convection] is the still air total path thermal resistance or in this case 12.5°C/Watt and,

“Airflow in LFM” is the net air movement flow rate immediately at the converter.

This equation simplifies an otherwise complex aerodynamic model but is a useful starting point. The “Airflow Constant” is dependent on the fan and enclosure geometry. For example, if 200 LFM of airflow reduces the effective natural convection thermal resistance by one half, the airflow constant would be 0.005. There is no practical way to publish a “one size fits all” airflow constant because of variations in airflow direction, heatsink orientation, adjacent walls, enclosure geometry, etc. Each application must be determined empirically and the equation is primarily a way to help understand the cooling arithmetic.

This equation basically says that small amounts of forced airflow are quite effective removing the heat. But very high airflows give diminishing returns. Conversely, no forced airflow causes considerable heat buildup. At zero airflow, cooling occurs only because of natural convection over the heatsink. Natural convection is often well below 50 LFM, not much of a breeze.

While these equations are useful as a conceptual aid, most users find it very difficult to measure actual airflow rates at the converter. Even if you know the velocity specifications of the fan, this does not usually relate directly to the enclosure geometry. Be sure to use a considerable safety margin doing thermal analysis. If in doubt, measure the actual heat sink temperature with a calibrated thermocouple, RTD or thermistor. Safe operation should keep the heat sink below 100°C.

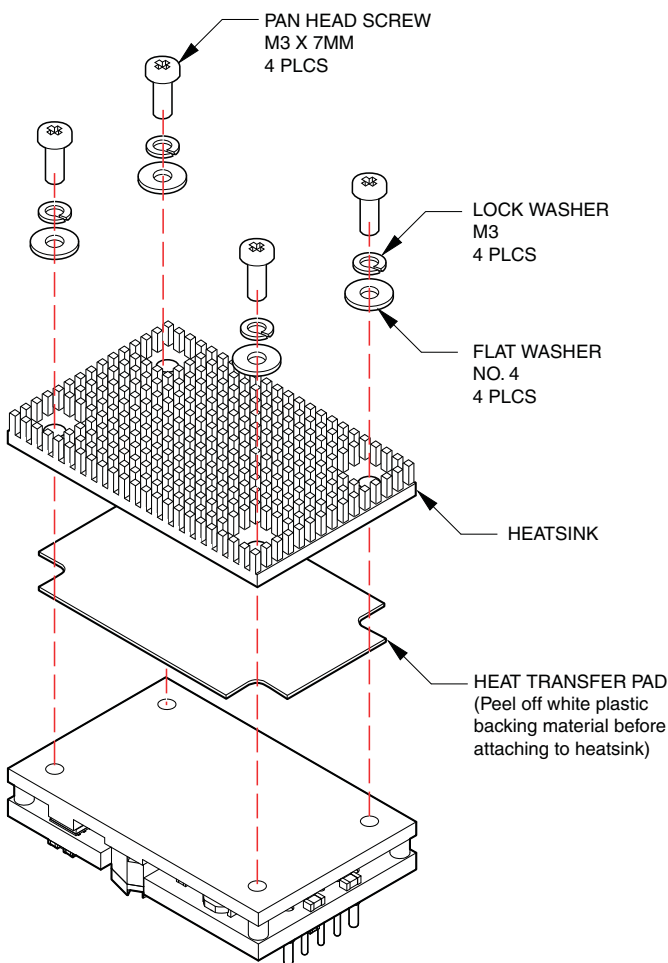

Figure 7. Model UVQ Heatsink Assembly Diagram

When assembling these kits onto the converter, include ALL kit hardware to assure adequate mechanical capture and proper clearances. Thread relief is 0.090" (2.3mm).

**Calculating Maximum Power Dissipation**

To determine the maximum amount of internal power dissipation, find the ambient temperature inside the enclosure and the airflow (in Linear Feet per Minute – LFM) at the converter. Determine the expected heat dissipation using the Efficiency curves and the converter Input Voltage. You should also compensate for lower atmospheric pressure if your application altitude is considerably above sea level.

The general procedure is to compute the expected temperature rise of the heatsink. If the heatsink exceeds +100°C. either increase the airflow and/or reduce the power output. Start with this equation:

$$\text{Internal Heat Dissipation [Pd in Watts]} = (Ts - Ta) / R\Theta \text{ [at airflow]} \text{ [6]}$$

where “Ta” is the enclosure ambient air temperature and,

where “Ts” is the heatsink temperature and,

where “RΘ [at airflow]” is a specific heat transfer thermal resistance (in degrees Celsius per Watt) for a particular heat sink at a set airflow rate. We have already estimated RΘ [at airflow] in the equations above.

Note particularly that Ta is the air temperature inside the enclosure at the heatsink, not the outside air temperature. Most enclosures have higher internal temperatures, especially if the converter is “downwind” from other heat-producing circuits. Note also that this “Pd” term is only the internal heat dissipated inside the converter and not the total power output of the converter.

We can rearrange this equation to give an estimated temperature rise of the heatsink as follows:

$$Ts = (Pd \times R\Theta \text{ [at airflow]}) + Ta \text{ [7]}$$

| Heatsink Kit *<br>Model Number | Still Air (Natural convection)<br>thermal resistance | Heatsink height<br>(see drawing) |
|--------------------------------|--|----------------------------------|
| HS-QB25-UVQ                    | 12°C/Watt  | 0.25" (6.35mm)                   |
| HS-QB50-UVQ                    | 10.6°C/Watt  | 0.50" (12.7mm)                   |
| HS-QB100-UVQ                   | 8°C/Watt   | 1.00" (25.4mm)                   |

\* Kit includes heatsink, thermal pad and mounting hardware. These are non-RoHS models. For RoHS-6 versions, add “-C” to the model number (e.g., HS-QB25-UVQ-C).

**Heat Sink Example**

Assume an efficiency of 92% and power output of 100 Watts. Using equation [4], Pd is about 8.7 Watts at an input voltage of 48 Volts. Using +30°C ambient temperature inside the enclosure, we wish to limit the heat sink temperature to +90°C maximum baseplate temperature to stay well away from thermal shut-down. The +90°C. figure also allows some margin in case the ambient climbs above +30°C or the input voltage varies, giving us less than 92% efficiency. The heat sink and airflow combination must have the following characteristics:

$$8.7 \text{ W} = (90-30) / R\Theta[\text{airflow}] \text{ or,}$$

$$R\Theta[\text{airflow}] = 60/8.7 = 6.9^\circ\text{C/W}$$

Since the ambient thermal resistance of the heatsink and pad is 12.5°C/W, we need additional forced cooling to get us down to 6.9°C/W. Using a hypothetical airflow constant of 0.005, we can rearrange equation [5] as follows:

$$(\text{Required Airflow, LFM}) \times (\text{Airflow Constant}) = R\Theta[\text{Nat.Convection}] / R\Theta[\text{at airflow}] - 1$$

or, (Required Airflow, LFM) x (Airflow Constant) = 12.5/6.9 – 1 = 0.81 and, rearranging again,

$$(\text{Required Airflow, LFM}) = 0.81/0.005 = 162 \text{ LFM}$$

162 LFM is the minimum airflow to keep the heatsink below +90°C. Increase the airflow to several hundred LFM to reduce the heatsink temperature further and improve life and reliability.

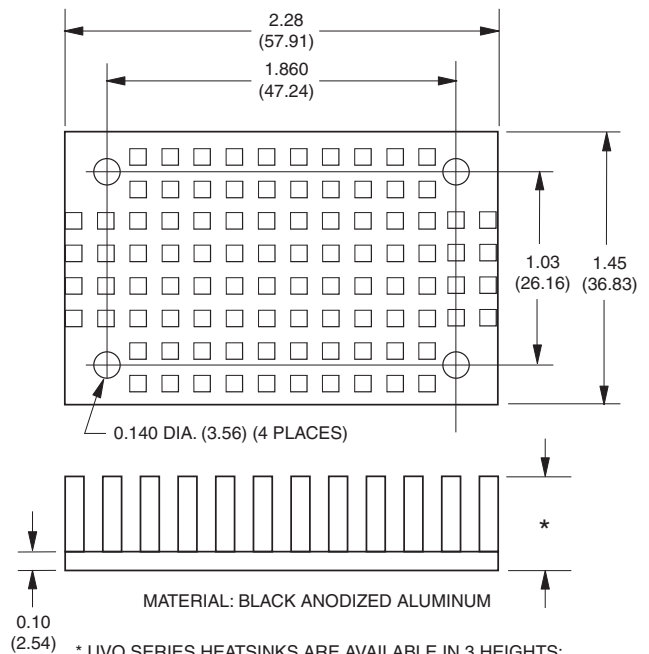

Dimensions in inches (mm)



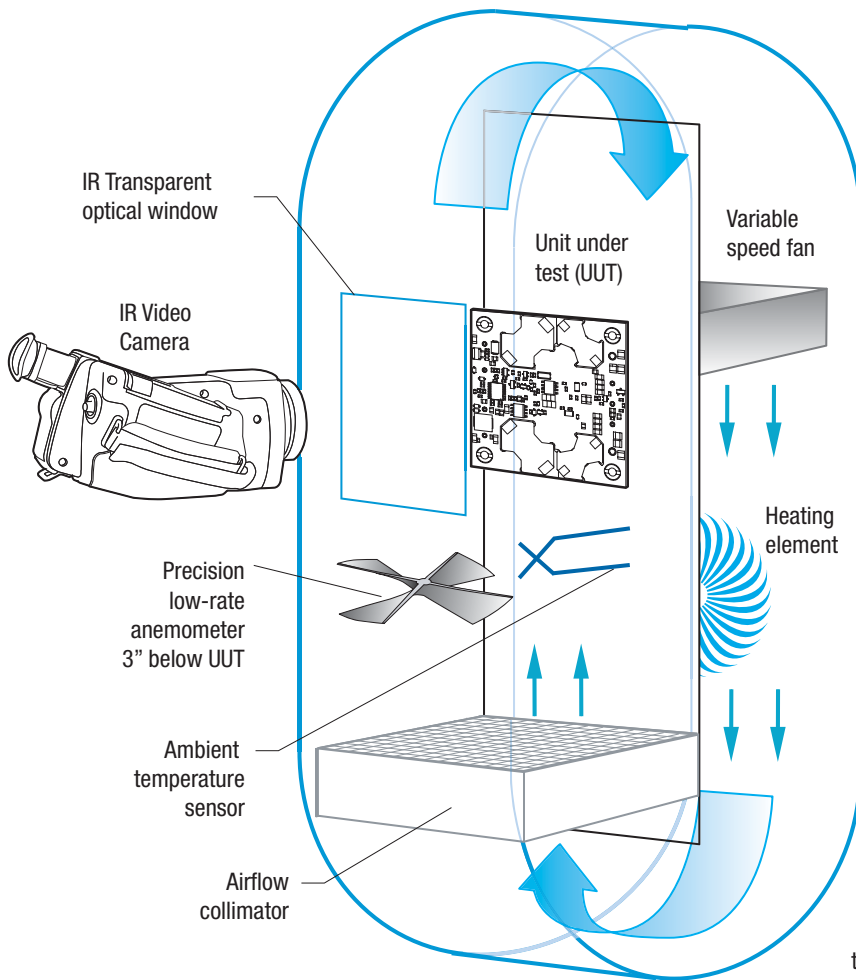

Figure 9. Vertical Wind Tunnel

**Vertical Wind Tunnel**

Murata Power Solutions employs a computer controlled custom-designed closed loop vertical wind tunnel, infrared video camera system, and test instrumentation for accurate airflow and heat dissipation analysis of power products. The system includes a precision low flow-rate anemometer, variable speed fan, power supply input and load controls, temperature gauges, and adjustable heating element.

The IR camera monitors the thermal performance of the Unit Under Test (UUT) under static steady-state conditions. A special optical port is used which is transparent to infrared wavelengths.

Both through-hole and surface mount converters are soldered down to a 10" x 10" host carrier board for realistic heat absorption and spreading. Both longitudinal and transverse airflow studies are possible by rotation of this carrier board since there are often significant differences in the heat dissipation in the two airflow directions. The combination of adjustable airflow, adjustable ambient heat, and adjustable Input/Output currents and voltages mean that a very wide range of measurement conditions can be studied.

The collimator reduces the amount of turbulence adjacent to the UUT by minimizing airflow turbulence. Such turbulence influences the effective heat transfer characteristics and gives false readings. Excess turbulence removes more heat from some surfaces and less heat from others, possibly causing uneven overheating.

Both sides of the UUT are studied since there are different thermal gradients on each side. The adjustable heating element and fan, built-in temperature gauges, and no-contact IR camera mean that power supplies are tested in real-world conditions.

