



COMPLIES WITH REQUIREMENTS OF

- \* IEC STANDARDS 947-4-1 AND 947-5-1 LOW VOLTAGE DIRECTIVE
- \* IEC = INTERNATIONAL ELECTROTECHNICAL COMMISSION
- \* CE TESTING AND EVALUATION PERFORMED BY THE UNDERWRITERS LABORATORIES AS A THIRD PARTY PARTICIPANT



### RECOMMENDED CHASSIS CUTOUT BOTTOM VIEW

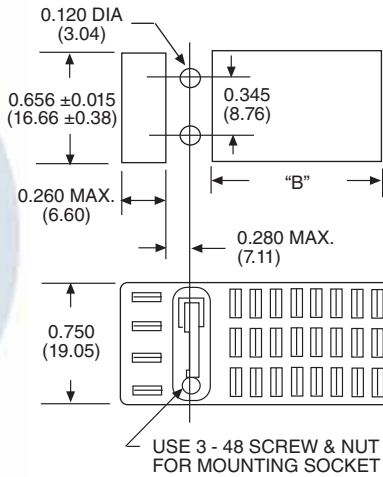

**OUTLINE DIMENSIONS**  
DIMENSIONS SHOWN IN INCHES & (MILLIMETERS).  
TOLERANCES: ± 0.010 (± 0.25)  
UNLESS OTHERWISE SHOWN

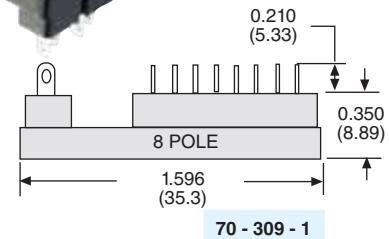
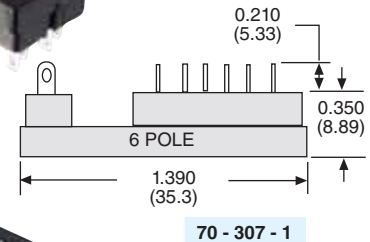
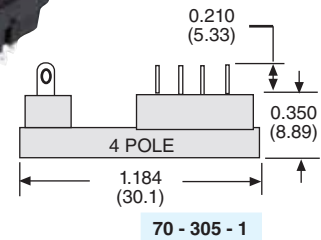
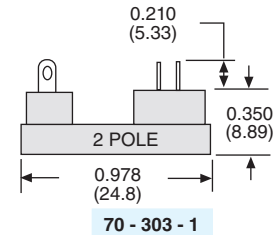

### CHASSIS CUTOUT

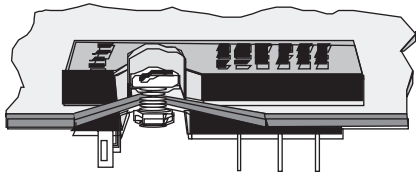

### CHASSIS CUTOUT DIMENSION "B"

SPDT DPDT	4PDT	6PDT	8PDT
0.343 (8.71)	0.562 (14.27)	0.781 (19.84)	1.00 (25.4)

## GENERAL SPECIFICATIONS (@ 25°C)

	UNITS	
<b>NUMBER OF TERMINALS</b>		8, 14 or 20
<b>ELECTRICAL RATING</b>		
Nominal Voltage Rating:	Volts	300
Nominal Current Rating:	Amps	10
<b>DIELECTRIC STRENGTH</b>		
Output to Adjacent output Terminals:	V rms	1000
Output to Input Terminals:	V rms	1000
Terminals to Rail Chassis:	V rms	1000
<b>CONSTRUCTION</b>		
Protection Category (Finger Safe):	IEC	N / A
Internal Metal Tracks:		Copper Alloy, Zinc Plated
<b>TEMPERATURE</b>		
Operating, Lower:	°C	-40
Operating, Upper:	°C	+80
<b>MISCELLANEOUS</b>		
Chassis Mount Screw Torque:	Lb-in / Nm	N / A
Flammability Rating:		
Wire Size:	AWG/mm <sup>2</sup>	20 - 18 / 0.5 - 0.8
Body Color:		Black
Weight:	grams	4.3 - 6.9

**Mating Relay**  
**67**

See section 1

Mating Hold Down Clips

(70-303-1) 16-875-1

(70-305-1) 16-875-2

(70-307-1) 16-875-3

(70-309-1) 16-1120-8

HOLD DOWN CLIPS ARE INCLUDED

STANDARD PART NUMBER	DESCRIPTION
70 - 303 - 1	2 POLE SOLDER TERMINALS
70 - 305 - 1	4 POLE SOLDER TERMINALS
70 - 307 - 1	6 POLE SOLDER TERMINALS
70 - 309 - 1	8 POLE SOLDER TERMINALS



COMPLIES WITH REQUIREMENTS OF

- \* IEC STANDARDS 947-4-1 AND 947-5-1 LOW VOLTAGE DIRECTIVE
- \* IEC = INTERNATIONAL ELECTROTECHNICAL COMMISSION
- \* CE TESTING AND EVALUATION PERFORMED BY THE UNDERWRITERS LABORATORIES AS A THIRD PARTY PARTICIPANT

### RECOMMENDED PRINTED CIRCUIT LAYOUT TOP VIEW

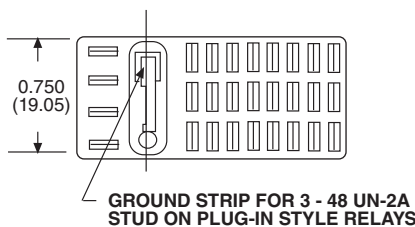
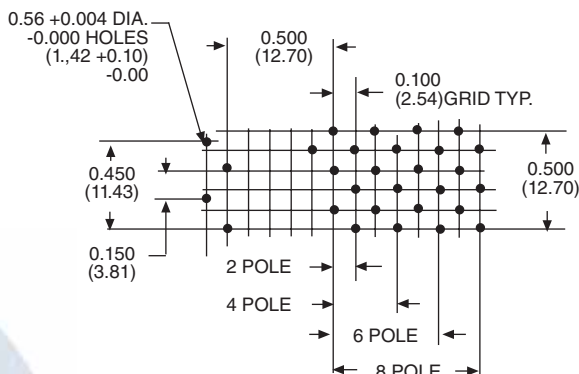

**NOTE:**  
WHEN INSTALLING SOCKET(S) INTO A PRINTED CIRCUIT BOARD, USE PLUG-IN STYLE RELAYS FOR MAXIMUM TERMINAL CONTACT WITH MATING SOCKET. PLUG-IN STYLE RELAYS HAVE A GROUNDING STUD AND ARE RECOMMENDED FOR USE WITH ALL SOCKET STYLES.

### OUTLINE DIMENSIONS

DIMENSIONS SHOWN IN INCHES & (MILLIMETERS).  
TOLERANCES : ± 0.010 ( ± 0.25 )  
UNLESS OTHERWISE SHOWN

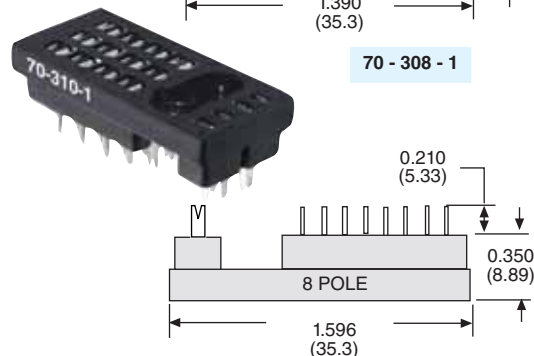
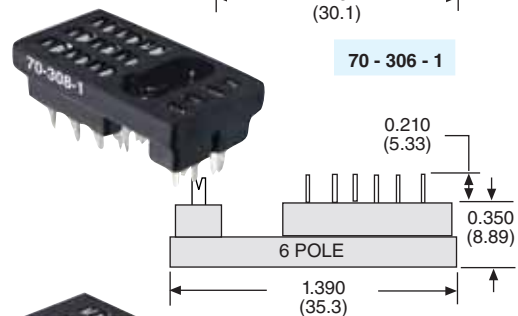
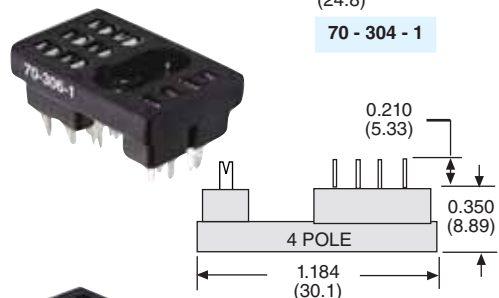
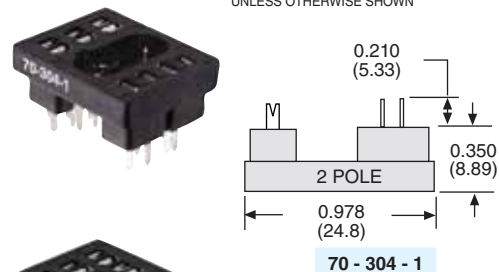

HOLD DOWN CLIPS ARE INCLUDED

**Mating Relay**  
**67**

See section 1

**Mating Hold Down Clips**

(70-304-1) 16-875-1

(70-306-1) 16-875-2

(70-308-1) 16-875-3

(70-310-1) 16-1120-8

## GENERAL SPECIFICATIONS (@ 25°C)

	UNITS	
<b>NUMBER OF TERMINALS</b>		8, 14 or 20
<b>ELECTRICAL RATING</b>		
Nominal Voltage Rating:	Volts	300
Nominal Current Rating:	Amps	10
<b>DIELECTRIC STRENGTH</b>		
Output to Adjacent output Terminals:	V rms	1000
Output to Input Terminals:	V rms	1000
Terminals to Rail Chassis:	V rms	1000
<b>CONSTRUCTION</b>		
Protection Category (Finger Safe):	IEC	N / A
Internal Metal Tracks:		Copper Alloy, Zinc Plated
<b>TEMPERATURE</b>		
Operating, Lower:	°C	-40
Operating, Upper:	°C	+80
<b>MISCELLANEOUS</b>		
Chassis Mount Screw Torque:	Lb-in / Nm	N / A
Flammability Rating:		
Wire Size:	AWG/mm <sup>2</sup>	N / A
Body Color:		Black
Weight:	grams	4.3 - 6.9

STANDARD PART NUMBER	DESCRIPTION
70 - 304 - 1	2 POLE PRINTED CIRCUIT TERMINALS
70 - 306 - 1	4 POLE PRINTED CIRCUIT TERMINALS
70 - 308 - 1	6 POLE PRINTED CIRCUIT TERMINALS
70 - 310 - 1	8 POLE PRINTED CIRCUIT TERMINALS

# Mouser Electronics

Authorized Distributor

Click to View Pricing, Inventory, Delivery & Lifecycle Information:

[Magnecraft / Schneider Electric:](#)

[70-309-1](#)

[Schneider Electric:](#)

[70-303-1](#) [70-308-1](#) [70-304-1](#) [70-310-1](#) [70-305-1](#) [70-307-1](#) [70-306-1](#)