

“Mini” SiSonic™ Microphone Specification

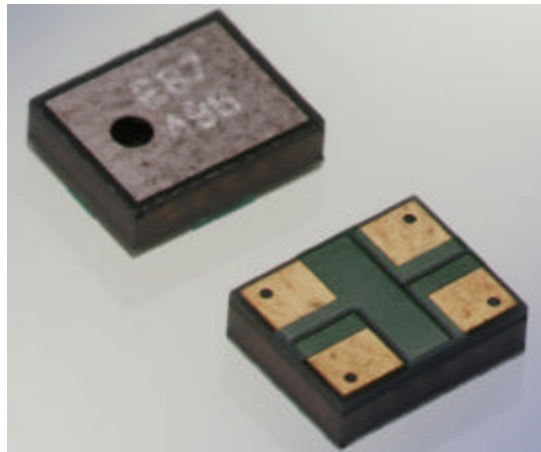

Knowles Acoustics
1151 Maplewood Drive
Itasca, IL 60143

1. DESCRIPTION AND APPLICATION

1.1 Description

“Mini” Surface Mount Silicon Microphone
with standard RF Protection

1.2 Application

Hand held telecommunication devices

2. PART MARKING

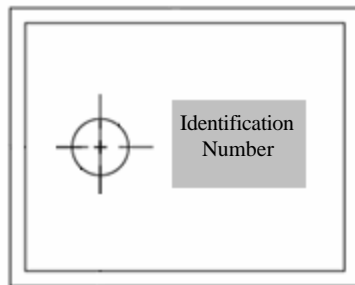

Pin 1

Identification Number Convention

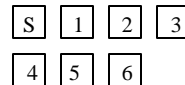

S: Manufacturing Location

“S” – Knowles Electronics Suzhou
Suzhou, China

“No Alpha Character” – Knowles Electronics Itasca
Itasca, IL USA

“E” – Engineering Samples

Digits 1 – 6: Job Identification Number

3. TEMPERATURE RANGE

3.1 Operating Temperature Range: -40°C to $+100^{\circ}\text{C}$

3.2 Storage Temperature Range: -40°C to $+100^{\circ}\text{C}$

4. ACOUSTIC & ELECTRICAL SPECIFICATIONS

	Symbol	Condition	Limits			Unit
			Min.	Nom.	Max.	
Directivity		Omni-directional				
Sensitivity	S	@ 1kHz (0dB=1V/Pa)	-46	-42	-38	dB
Output impedance	Z _{OUT}	@ 1kHz (0dB=1V/Pa)	n/a	n/a	100	Ω
Current Consumption	I _{DSS}	across 1.5 to 5.5 volts	0.100	n/a	0.250	mA
Signal to Noise Ratio	S/N	@ 1kHz (0dB=1V/Pa)	55	59	n/a	dB
Supply Voltage	Vs		1.5	n/a	5.5	V
Typical Input Referred Noise	ENL	A-weighted	n/a	35	n/a	dBa SPL
Sensitivity Loss across Voltage		Change in sensitivity over 5.5v to 1.5v	No Change Across Voltage Range			dB
Maximum Input Sound Level		At 100dB SPL, THD < 1% At 115dB SPL, THD = < 10%				dB

5. FREQUENCY RESPONSE CURVE

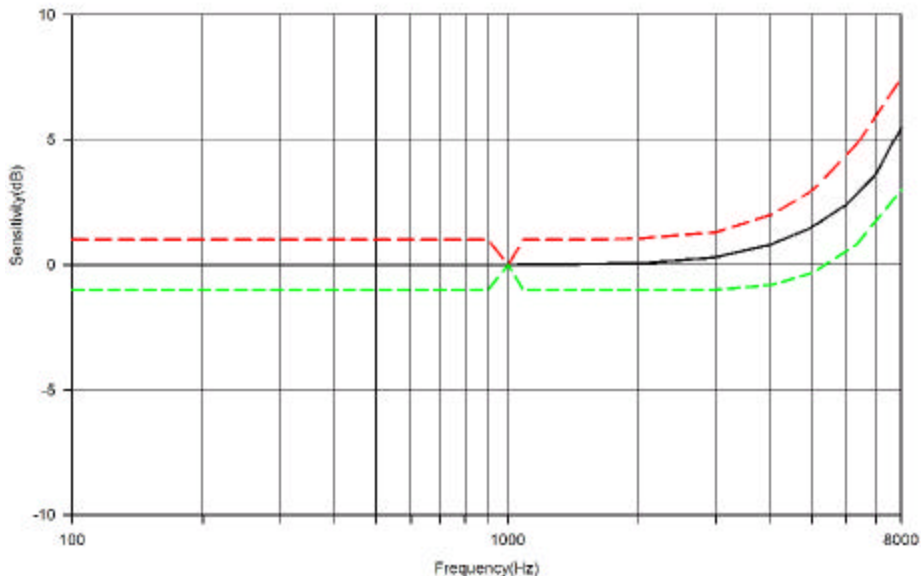

6. MECHANICAL SPECIFICATIONS

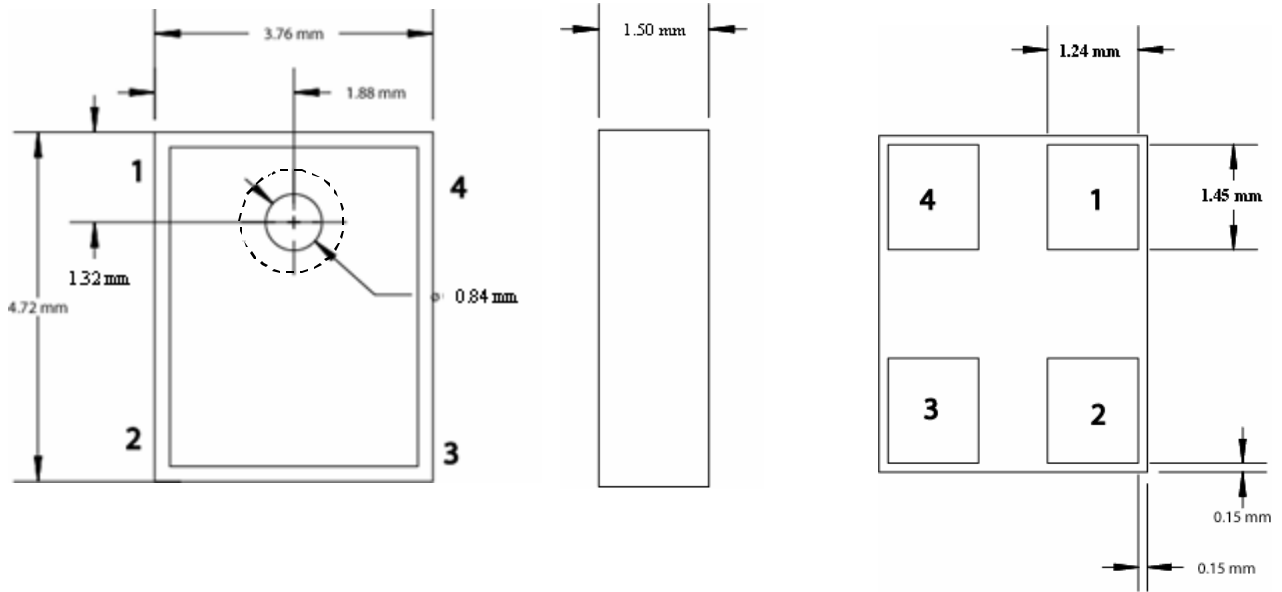

Pin Output	
Pin #	Function
1	Output
2	Ground
3	Ground
4	Power

Item	Dim.	Tol. (+/-)	Units
Height	1.50	+0.20 -0.10	mm
Length	4.72	0.10	mm
Width	3.76	0.10	mm
Port Hole	0.84	0.15	mm
Short Edge to C.L. Port	1.32	0.25	mm
Long Edge to C.L. Port	1.88	0.25	mm
Weight	0.08	grams	
Coplanarity	<0.1	mm	
Acoustic Seal I.D. (typical)	1.55	mm	

Note: (Tolerance +/-0.15mm unless otherwise specified)

7. RECOMMENDED CUSTOMER LAND PATTERN

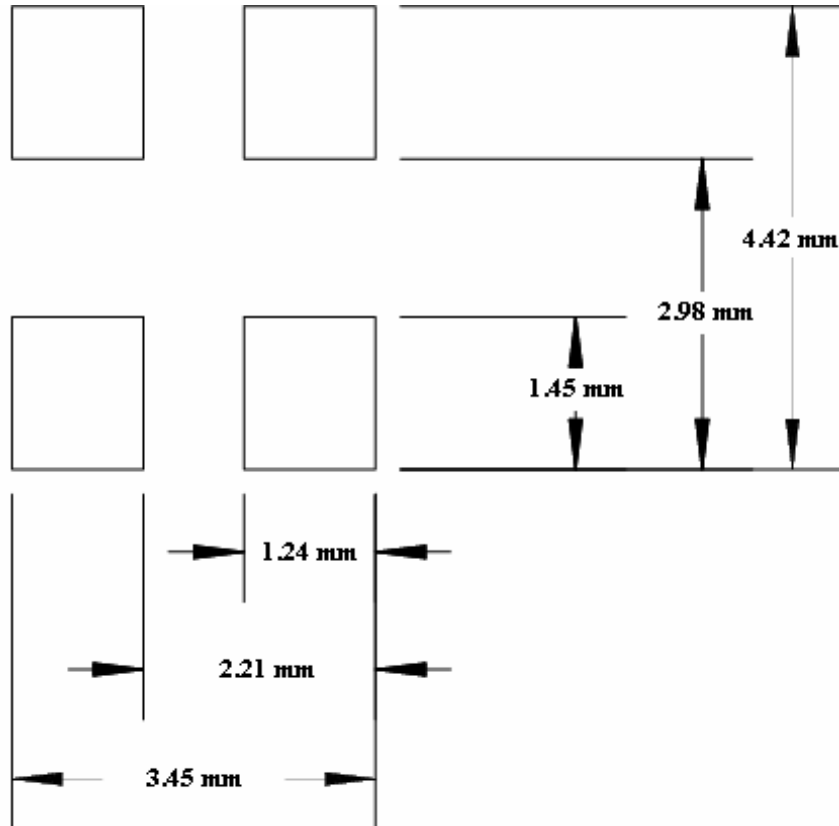

8. RECOMMENDED SOLDER STENCIL PATTERN

N/A

9. RECOMMENDED INTERFACE CIRCUIT

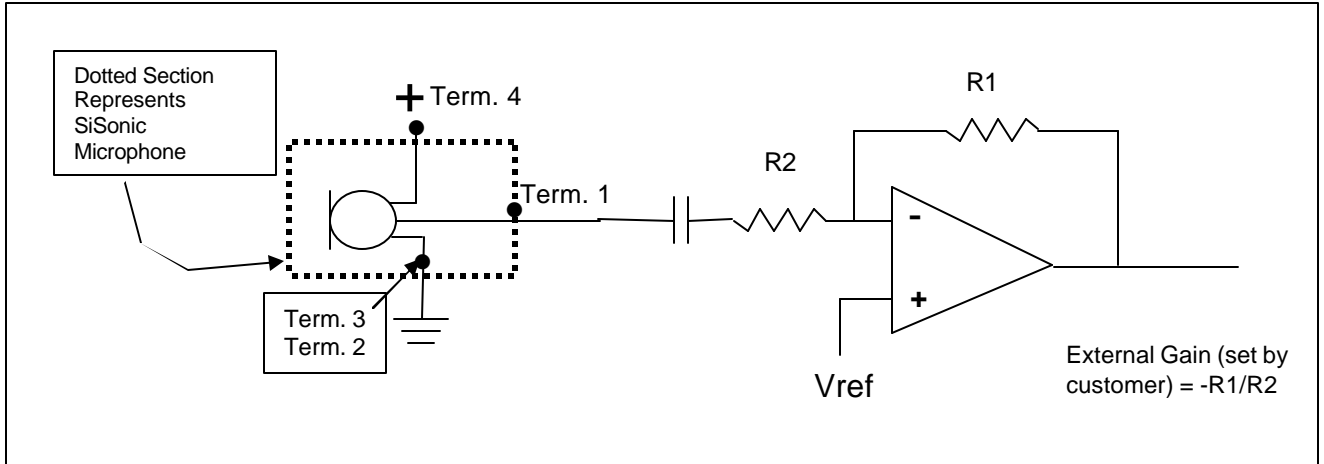

10. PACKAGING DETAIL

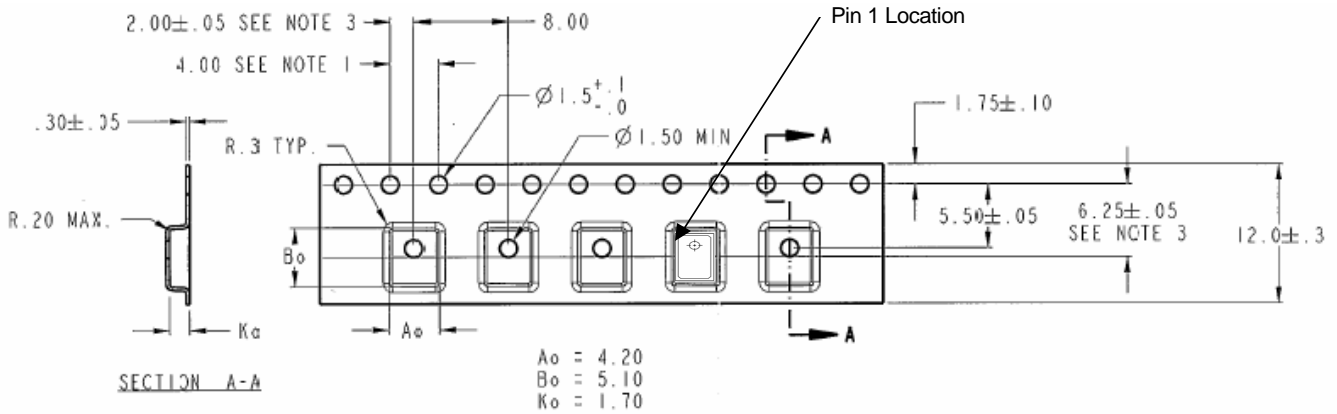

NOTES:

1. 10 SPROCKET HOLE PITCH CUMULATIVE TOLERANCE ± 0.2
2. CAMBER IN COMPLIANCE WITH EIA 481
3. POCKET POSITION RELATIVE TO SPROCKET HOLE MEASURED AS TRUE POSITION OF POCKET, NOT POCKET HOLE

Model Number	Suffix	Reel Diameter	Quantity per Reel
SPM0102ND3	-2	7"	1200
SPM0102ND3	-3	13"	4500

Leader Length	800mm or minimum of 100 empty pockets
Label	Label applied to external package and direct to reel. Per JEDEC.
Empty Units	No consecutive empty pockets; No more than 3 empty pockets per reel. (Does not include empty pockets for leader/follower)

11. SOLDER REFLOW PROFILE

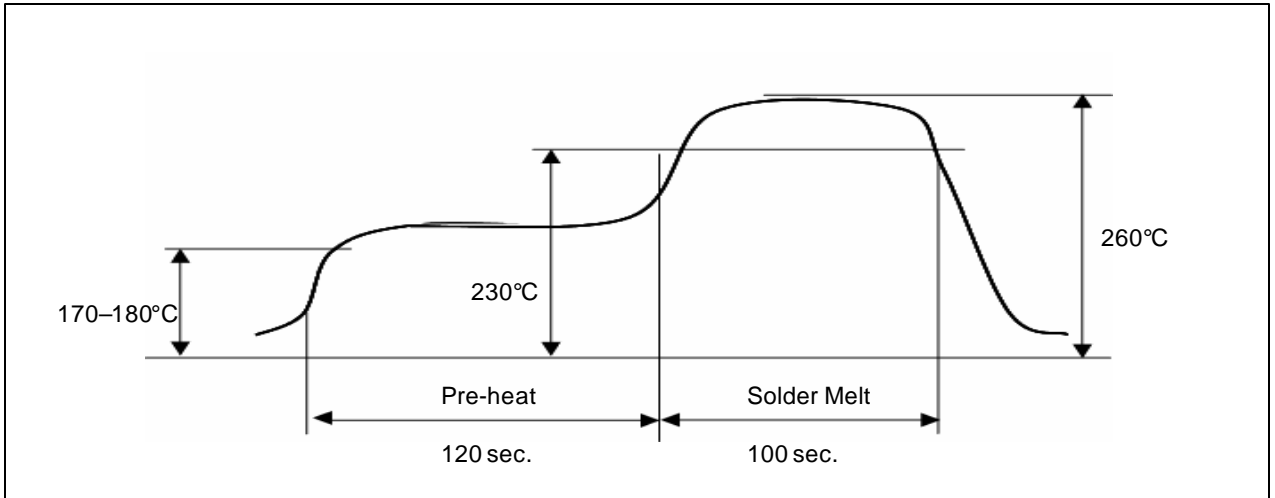

<i>Stage</i>	<i>Temperature Profile</i>	<i>Time (maximum)</i>
Pre-heat	170 ~ 180 C	120 sec.
Solder Melt	Above 230 C	100 sec.
Peak	260 C maximum	30 sec.

Notes:

1. Do not pull a vacuum over the port hole of the microphone. Pulling a vacuum over the port hole can damage the device.
2. Do not board wash after the reflow process. Board washing and cleaning agents can damage the device. Do not expose to ultrasonic processing or cleaning.
3. Number of Reflow = recommend no more than 3 cycles.

12. ADDITIONAL NOTES

- (A) Packaging (reference SiSonic_Packaging_Spec.pdf)
- (B) Shelf life: Twelve (12) months when devices are to be stored in factory supplied, unopened ESD moisture sensitive bag under maximum environmental conditions of 30°C, 70% R.H.
- (C) Exposure: Devices should not be exposed to high humidity, high temperature environment. MSL (moisture sensitivity level) Class 2A.
- (D) Out of bag: Maximum of 90 days out of ESD moisture sensitive bag, assuming maximum conditions of 30°C/70% R.H.

13. RELIABILITY SPECIFICATIONS

Note: After test conditions are performed, the sensitivity of the microphone shall not deviate more than 3dB from its initial value.

Test	Description
Thermal Shock	Microphone unit must operate when exposed to air-to-air thermal shock 100 cycles, from -40°C to +125°C. (IEC 68-2-4),
High Temperature Storage Test	Microphone unit must maintain sensitivity after storage at +105°C for 1,000 hours. (IEC 68-2-2 Test Ba)
Low Temperature Storage Test	Microphone unit must maintain sensitivity after storage at -40°C for 1,000 hours. (IEC 68-2-1 Test Aa)
High Temperature Operating Test	Microphone unit must operate within sensitivity specifications for 1,000 hours at 105°C. (IEC 68-2-2 Test Ba)
Low Temperature Operating Test	Microphone unit must operate within sensitivity specifications for 1,000 hours at -40°C. (IEC 68-2-1 Test Aa)
Humidity Test	Tested under Bias at 85°C/85% R.H. for 1,000 hours. (JESD22-A101A-B)
Vibration Test	Microphone unit must operate under test condition: 4 cycles, from 20 to 2,000 Hz in each direction (x,y,z), 48 minutes, using peak acceleration of 20 G (+20%, -0%). (MIL 883E, method 2007.2, A)
Electrostatic Discharge	Tested to 8kV direct contact discharge or 15kV air discharge as specified by IEC 1000-4-2, level 3 and level 4.
Reflow	Microphone is tested to 5 passes through reflow oven, with microphone mounted upside-down under conditions of 260°C for 30 seconds maximum.
Mechanical Shock	Microphone must operate after exposure to shock test of 10,000 G per IEC 68-2-27, Ea.

14. SPECIFICATION REVISIONS

Revision	Detailed Specification Changes	Date
A	Preliminary Specification Release	01-06-2005
B	Updated Response Curve	02-14-2005
C	Official Release. Section 6: Port Hole Dimension, Location	03-18-2005

The information contained in this literature is based on our experience to date and is believed to be reliable and it is subject to change without notice. It is intended as a guide for use by persons having technical skill at their own discretion and risk. We do not guarantee favorable results or assume any liability in connection with its use. Dimensions contained herein are for reference purposes only. For specific dimensional requirements consult factory. This publication is not to be taken as a license to operate under, or recommendation to infringe any existing patents. This supersedes and voids all previous literature.