

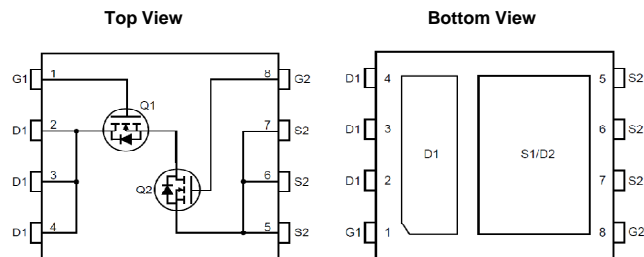
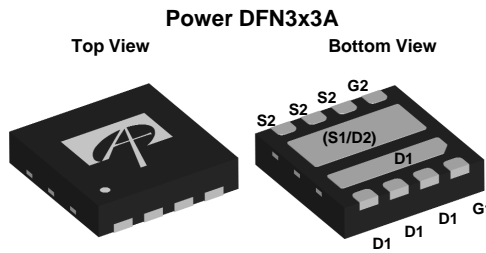
### General Description

The AON7932 is designed to provide a high efficiency synchronous buck power stage with optimal layout and board space utilization. It includes two specialized MOSFETs in a dual Power DFN3x3A package. The Q1 "High Side" MOSFET is designed to minimize switching losses. The Q2 "Low Side" MOSFET use advance trench technology with a monolithically integrated Schottky to provide excellent  $R_{DS(ON)}$  and low gate charge. The AON7932 is well suited for use in compact DC/DC converter applications.

### Product Summary

	Q1	Q2
$V_{DS}$	30V	30V
$I_D$ (at $V_{GS}=10V$ )	26A	35A
$R_{DS(ON)}$ (at $V_{GS}=10V$ )	<20m $\Omega$	<12m $\Omega$
$R_{DS(ON)}$ (at $V_{GS} = 4.5V$ )	<30m $\Omega$	<15m $\Omega$

100% UIS Tested  
 100% Rg Tested



### Absolute Maximum Ratings $T_A=25^\circ\text{C}$ unless otherwise noted

Parameter	Symbol	Max Q1	Max Q2	Units	
Drain-Source Voltage	$V_{DS}$	30		V	
Gate-Source Voltage	$V_{GS}$	$\pm 20$	$\pm 12$	V	
Continuous Drain Current	$I_D$	$T_C=25^\circ\text{C}$	26	35	A
		$T_C=100^\circ\text{C}$	16	22	
Pulsed Drain Current <sup>C</sup>	$I_{DM}$	70	110		
Continuous Drain Current	$I_{DSM}$	$T_A=25^\circ\text{C}$	6.6	8.1	A
		$T_A=70^\circ\text{C}$	5.3	6.5	
Avalanche Current <sup>C</sup>	$I_{AS}, I_{AR}$	18	17	A	
Avalanche Energy $L=0.1\text{mH}$ <sup>C</sup>	$E_{AS}, E_{AR}$	16	14	mJ	
Power Dissipation <sup>B</sup>	$P_D$	$T_C=25^\circ\text{C}$	23	25	W
		$T_C=100^\circ\text{C}$	9	10	
Power Dissipation <sup>A</sup>	$P_{DSM}$	$T_A=25^\circ\text{C}$	1.4	1.4	W
		$T_A=70^\circ\text{C}$	0.9	0.9	
Junction and Storage Temperature Range	$T_J, T_{STG}$	-55 to 150		$^\circ\text{C}$	

### Thermal Characteristics

Parameter	Symbol	Typ Q1	Max Q1	Typ Q2	Max Q2	Units
Maximum Junction-to-Ambient <sup>A</sup>	$R_{\theta JA}$	40	50	40	50	$^\circ\text{C/W}$
Maximum Junction-to-Ambient <sup>A,D</sup>						
Maximum Junction-to-Case	$R_{\theta JC}$	4.5	5.4	4.2	5	$^\circ\text{C/W}$

**Q1 Electrical Characteristics (T<sub>J</sub>=25°C unless otherwise noted)**

Symbol	Parameter	Conditions	Min	Typ	Max	Units
<b>STATIC PARAMETERS</b>						
BV <sub>DSS</sub>	Drain-Source Breakdown Voltage	I <sub>D</sub> =250μA, V <sub>GS</sub> =0V	30			V
I <sub>DSS</sub>	Zero Gate Voltage Drain Current	V <sub>DS</sub> =30V, V <sub>GS</sub> =0V T <sub>J</sub> =55°C			1 5	μA
I <sub>GSS</sub>	Gate-Body leakage current	V <sub>DS</sub> =0V, V <sub>GS</sub> = ±20V			100	nA
V <sub>GS(th)</sub>	Gate Threshold Voltage	V <sub>DS</sub> =V <sub>GS</sub> , I <sub>D</sub> =250μA	1.4	1.9	2.4	V
I <sub>D(ON)</sub>	On state drain current	V <sub>GS</sub> =10V, V <sub>DS</sub> =5V	70			A
R <sub>DS(ON)</sub>	Static Drain-Source On-Resistance	V <sub>GS</sub> =10V, I <sub>D</sub> =6.6A T <sub>J</sub> =125°C		16 24	20 29	mΩ
		V <sub>GS</sub> =4.5V, I <sub>D</sub> =5.3A		23	30	
g <sub>FS</sub>	Forward Transconductance	V <sub>DS</sub> =5V, I <sub>D</sub> =6.6A		33		S
V <sub>SD</sub>	Diode Forward Voltage	I <sub>S</sub> =1A, V <sub>GS</sub> =0V		0.75	1	V
I <sub>S</sub>	Maximum Body-Diode Continuous Current				20	A
<b>DYNAMIC PARAMETERS</b>						
C <sub>iss</sub>	Input Capacitance	V <sub>GS</sub> =0V, V <sub>DS</sub> =15V, f=1MHz	300	380	460	pF
C <sub>oss</sub>	Output Capacitance		110	160	210	pF
C <sub>riss</sub>	Reverse Transfer Capacitance		7	13	22	pF
R <sub>g</sub>	Gate resistance	V <sub>GS</sub> =0V, V <sub>DS</sub> =0V, f=1MHz	0.7	1.5	2.3	Ω
<b>SWITCHING PARAMETERS</b>						
Q <sub>g(10V)</sub>	Total Gate Charge	V <sub>GS</sub> =10V, V <sub>DS</sub> =15V, I <sub>D</sub> =6.6A		5.4	6.5	nC
Q <sub>g(4.5V)</sub>	Total Gate Charge			2.3		nC
Q <sub>gs</sub>	Gate Source Charge			1.3		nC
Q <sub>gd</sub>	Gate Drain Charge			1		nC
t <sub>D(on)</sub>	Turn-On DelayTime	V <sub>GS</sub> =10V, V <sub>DS</sub> =15V, R <sub>L</sub> =2.3Ω, R <sub>GEN</sub> =3Ω		10		ns
t <sub>r</sub>	Turn-On Rise Time			3		ns
t <sub>D(off)</sub>	Turn-Off DelayTime			15		ns
t <sub>f</sub>	Turn-Off Fall Time			5		ns
t <sub>rr</sub>	Body Diode Reverse Recovery Time	I <sub>F</sub> =6.6A, di/dt=500A/μs	6.8	8.5	10.2	ns
Q <sub>rr</sub>	Body Diode Reverse Recovery Charge	I <sub>F</sub> =6.6A, di/dt=500A/μs	12.8	16	19.2	nC

A. The value of R<sub>θJA</sub> is measured with the device mounted on 1in<sup>2</sup> FR-4 board with 2oz. Copper, in a still air environment with T<sub>A</sub>=25° C. The Power dissipation P<sub>DSM</sub> is based on R<sub>θJA</sub> and the maximum allowed junction temperature of 150° C. The value in any given application depends on the user's specific board design.

B. The power dissipation P<sub>D</sub> is based on T<sub>J(MAX)</sub>=150° C, using junction-to-case thermal resistance, and is more useful in setting the upper dissipation limit for cases where additional heatsinking is used.

C. Repetitive rating, pulse width limited by junction temperature T<sub>J(MAX)</sub>=150° C. Ratings are based on low frequency and duty cycles to keep initial T<sub>J</sub>=25° C.

D. The R<sub>θJA</sub> is the sum of the thermal impedance from junction to case R<sub>θJC</sub> and case to ambient.

E. The static characteristics in Figures 1 to 6 are obtained using <300μs pulses, duty cycle 0.5% max.

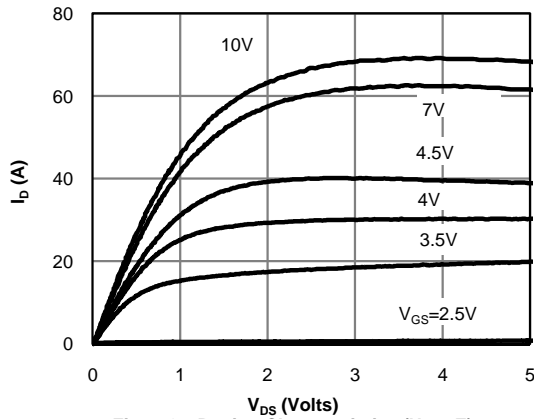
F. These curves are based on the junction-to-case thermal impedance which is measured with the device mounted to a large heatsink, assuming a maximum junction temperature of T<sub>J(MAX)</sub>=150° C. The SOA curve provides a single pulse rating.

G. The maximum current rating is limited by package.

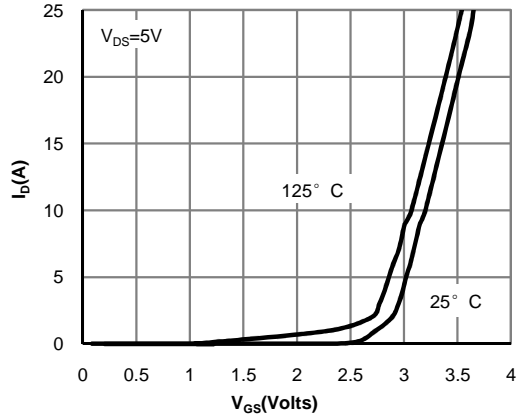
H. These tests are performed with the device mounted on 1 in<sup>2</sup> FR-4 board with 2oz. Copper, in a still air environment with T<sub>A</sub>=25° C.

COMPONENTS IN LIFE SUPPORT DEVICES OR SYSTEMS ARE NOT AUTHORIZED. AOS DOES NOT ASSUME ANY LIABILITY ARISING OUT OF SUCH APPLICATIONS OR USES OF ITS PRODUCTS. AOS RESERVES THE RIGHT TO IMPROVE PRODUCT DESIGN, FUNCTIONS AND RELIABILITY WITHOUT NOTICE.

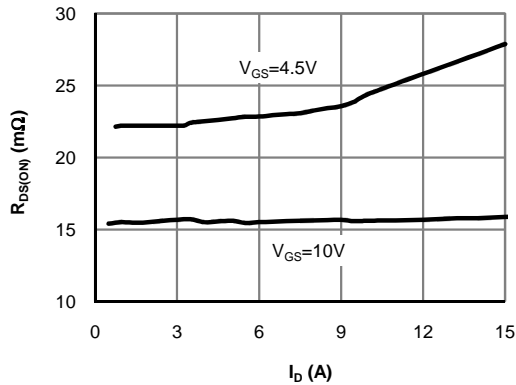
**Q1-CHANNEL: TYPICAL ELECTRICAL AND THERMAL CHARACTERISTICS**



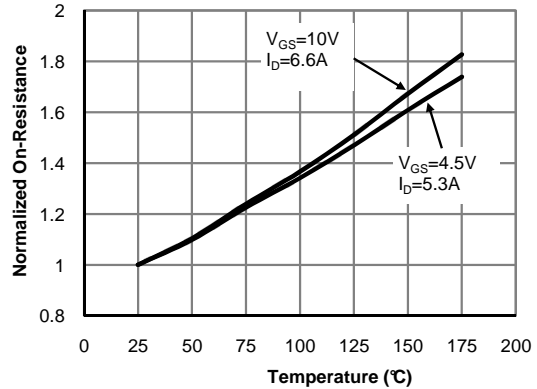
**Fig 1: On-Region Characteristics (Note E)**



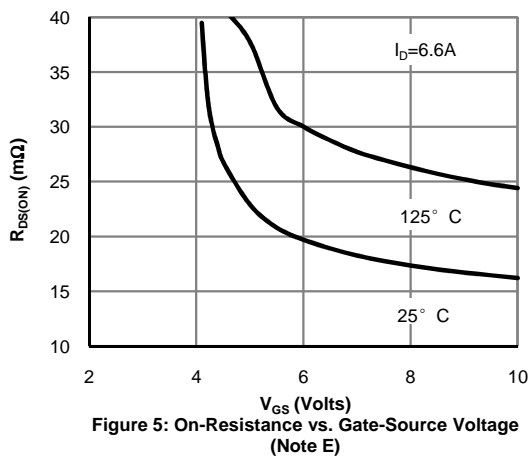
**Figure 2: Transfer Characteristics (Note E)**



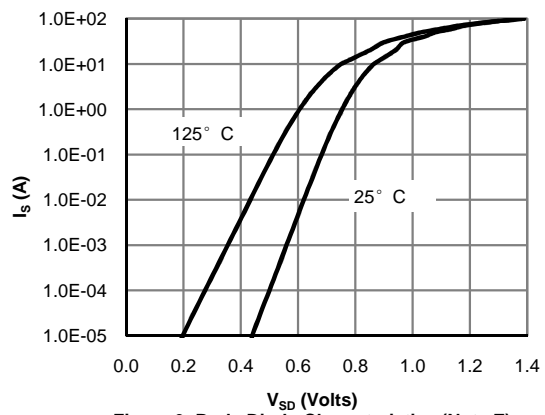
**Figure 3: On-Resistance vs. Drain Current and Gate Voltage (Note E)**



**Figure 4: On-Resistance vs. Junction Temperature (Note E)**

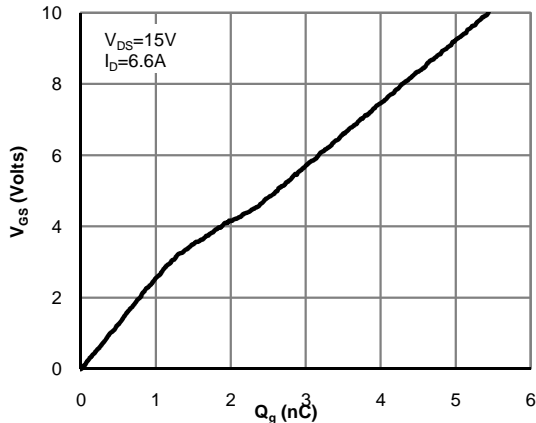


**Figure 5: On-Resistance vs. Gate-Source Voltage (Note E)**

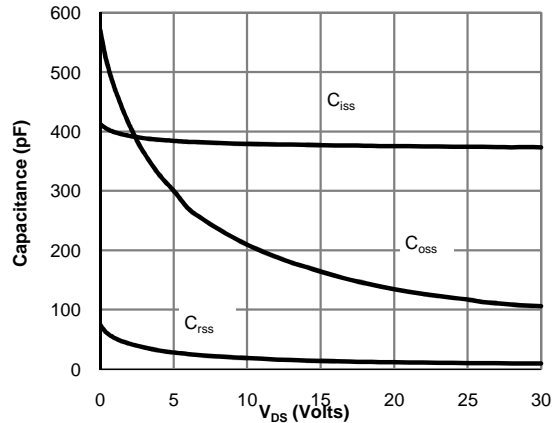


**Figure 6: Body-Diode Characteristics (Note E)**

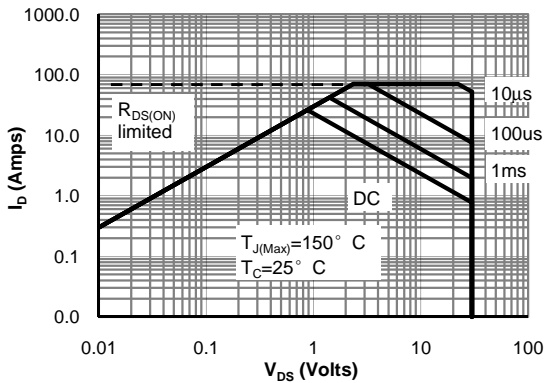
**Q1-CHANNEL: TYPICAL ELECTRICAL AND THERMAL CHARACTERISTICS**



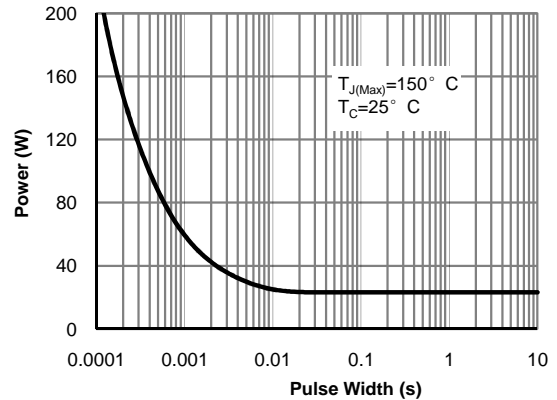
**Figure 7: Gate-Charge Characteristics**



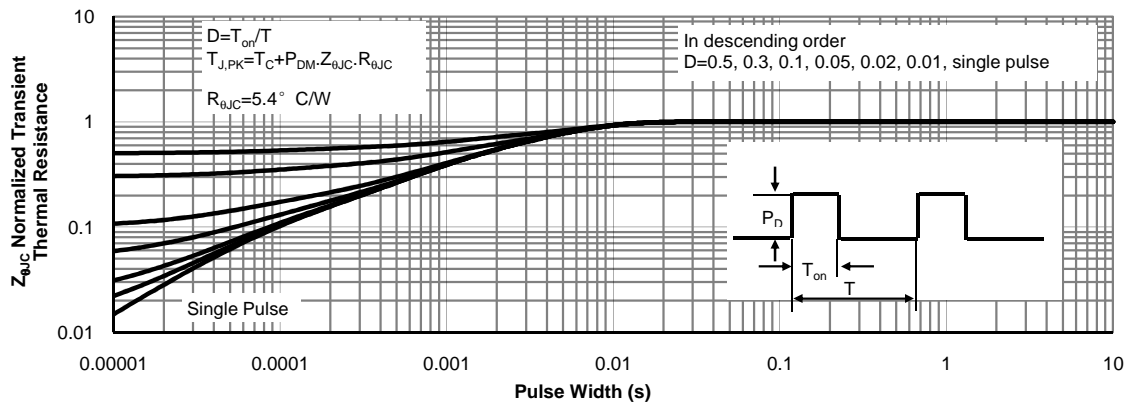
**Figure 8: Capacitance Characteristics**



**Figure 9: Maximum Forward Biased Safe Operating Area (Note F)**

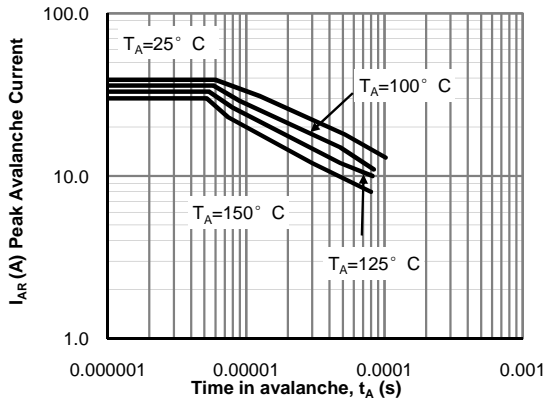


**Figure 10: Single Pulse Power Rating Junction-to-Case (Note F)**

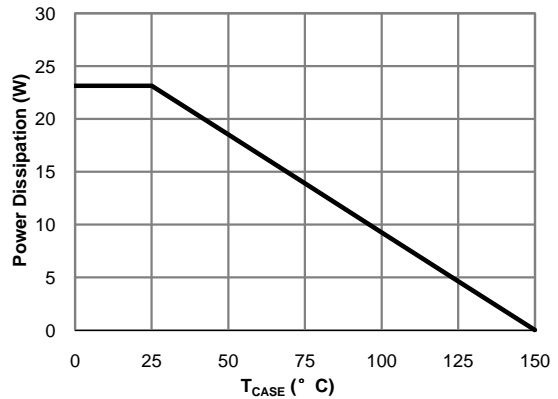


**Figure 11: Normalized Maximum Transient Thermal Impedance (Note F)**

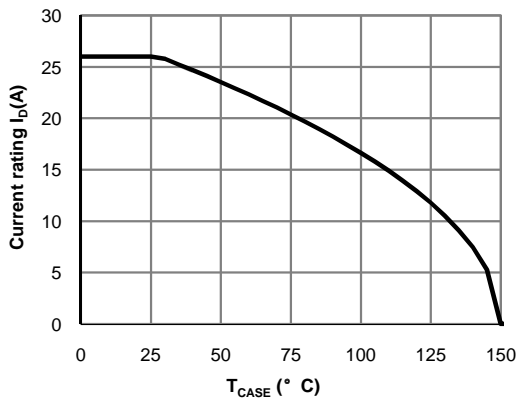
**Q1-CHANNEL: TYPICAL ELECTRICAL AND THERMAL CHARACTERISTICS**



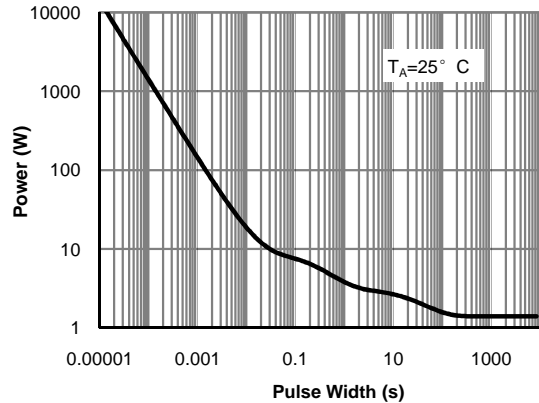
**Figure 12: Single Pulse Avalanche capability (Note C)**



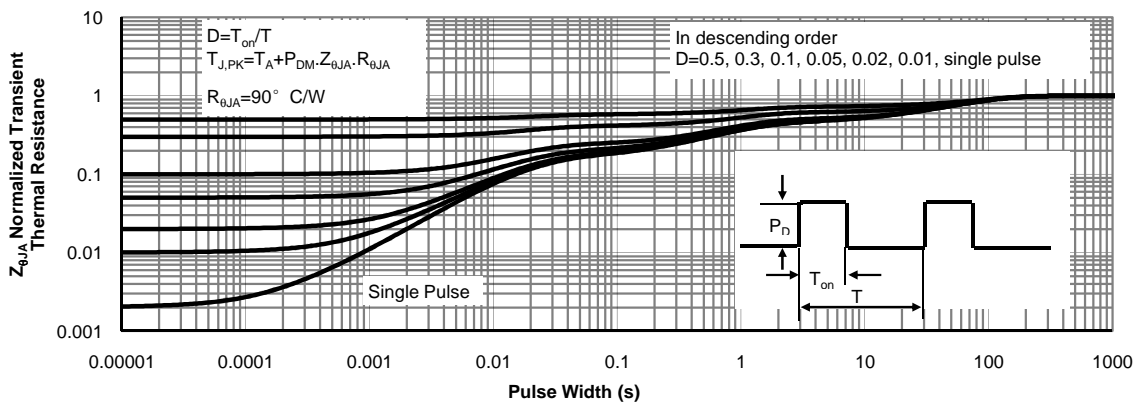
**Figure 13: Power De-rating (Note F)**



**Figure 14: Current De-rating (Note F)**



**Figure 15: Single Pulse Power Rating Junction-to-Ambient (Note H)**



**Figure 16: Normalized Maximum Transient Thermal Impedance (Note H)**

**Q2 Electrical Characteristics (T<sub>J</sub>=25°C unless otherwise noted)**

Symbol	Parameter	Conditions	Min	Typ	Max	Units
<b>STATIC PARAMETERS</b>						
BV <sub>DSS</sub>	Drain-Source Breakdown Voltage	I <sub>D</sub> =10mA, V <sub>GS</sub> =0V	30			V
I <sub>DSS</sub>	Zero Gate Voltage Drain Current	V <sub>DS</sub> =30V, V <sub>GS</sub> =0V T <sub>J</sub> =55°C			0.5 500	mA
I <sub>GSS</sub>	Gate-Body leakage current	V <sub>DS</sub> =0V, V <sub>GS</sub> = ±12V			100	nA
V <sub>GS(th)</sub>	Gate Threshold Voltage	V <sub>DS</sub> =V <sub>GS</sub> , I <sub>D</sub> =250μA	1.1	1.6	2.1	V
I <sub>D(ON)</sub>	On state drain current	V <sub>GS</sub> =10V, V <sub>DS</sub> =5V	110			A
R <sub>DS(ON)</sub>	Static Drain-Source On-Resistance	V <sub>GS</sub> =10V, I <sub>D</sub> =8.1A T <sub>J</sub> =125°C		10 15	12 18	mΩ
		V <sub>GS</sub> =4.5V, I <sub>D</sub> =6.5A		12	15	
g <sub>FS</sub>	Forward Transconductance	V <sub>DS</sub> =5V, I <sub>D</sub> =8.1A		50		S
V <sub>SD</sub>	Diode Forward Voltage	I <sub>S</sub> =1A, V <sub>GS</sub> =0V		0.45	0.7	V
I <sub>S</sub>	Maximum Body-Diode Continuous Current				30	A
<b>DYNAMIC PARAMETERS</b>						
C <sub>iss</sub>	Input Capacitance	V <sub>GS</sub> =0V, V <sub>DS</sub> =15V, f=1MHz	810	1020	1230	pF
C <sub>oss</sub>	Output Capacitance		77	111	150	pF
C <sub>riss</sub>	Reverse Transfer Capacitance		45	75	130	pF
R <sub>g</sub>	Gate resistance	V <sub>GS</sub> =0V, V <sub>DS</sub> =0V, f=1MHz	0.5	1	1.5	Ω
<b>SWITCHING PARAMETERS</b>						
Q <sub>g(10V)</sub>	Total Gate Charge	V <sub>GS</sub> =10V, V <sub>DS</sub> =15V, I <sub>D</sub> =8.1A		19	23	nC
Q <sub>g(4.5V)</sub>	Total Gate Charge			9		nC
Q <sub>gs</sub>	Gate Source Charge			4		nC
Q <sub>gd</sub>	Gate Drain Charge			3		nC
t <sub>D(on)</sub>	Turn-On DelayTime	V <sub>GS</sub> =10V, V <sub>DS</sub> =15V, R <sub>L</sub> =1.8Ω, R <sub>GEN</sub> =3Ω		11		ns
t <sub>r</sub>	Turn-On Rise Time			5		ns
t <sub>D(off)</sub>	Turn-Off DelayTime			29		ns
t <sub>f</sub>	Turn-Off Fall Time			6		ns
t <sub>rr</sub>	Body Diode Reverse Recovery Time	I <sub>F</sub> =8.1A, di/dt=500A/μs	4	5.4	7	ns
Q <sub>rr</sub>	Body Diode Reverse Recovery Charge	I <sub>F</sub> =8.1A, di/dt=500A/μs	4	5.3	7	nC

A. The value of R<sub>θJA</sub> is measured with the device mounted on 1in<sup>2</sup> FR-4 board with 2oz. Copper, in a still air environment with T<sub>A</sub>=25° C. The Power dissipation P<sub>DSM</sub> is based on R<sub>θJA</sub> and the maximum allowed junction temperature of 150° C. The value in any given application depends on the user's specific board design.

B. The power dissipation P<sub>D</sub> is based on T<sub>J(MAX)</sub>=150° C, using junction-to-case thermal resistance, and is more useful in setting the upper dissipation limit for cases where additional heatsinking is used.

C. Repetitive rating, pulse width limited by junction temperature T<sub>J(MAX)</sub>=150° C. Ratings are based on low frequency and duty cycles to keep initial T<sub>J</sub>=25° C.

D. The R<sub>θJA</sub> is the sum of the thermal impedance from junction to case R<sub>θJC</sub> and case to ambient.

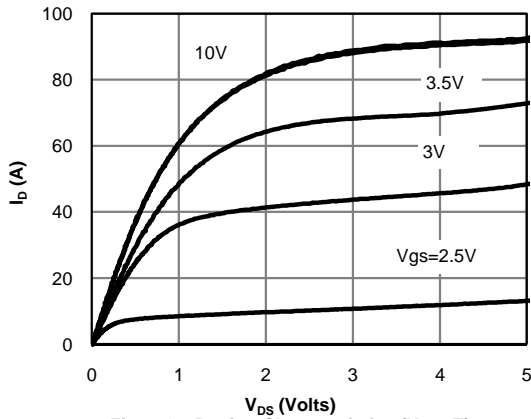
E. The static characteristics in Figures 1 to 6 are obtained using <300μs pulses, duty cycle 0.5% max.

F. These curves are based on the junction-to-case thermal impedance which is measured with the device mounted to a large heatsink, assuming a maximum junction temperature of T<sub>J(MAX)</sub>=150° C. The SOA curve provides a single pulse rating.

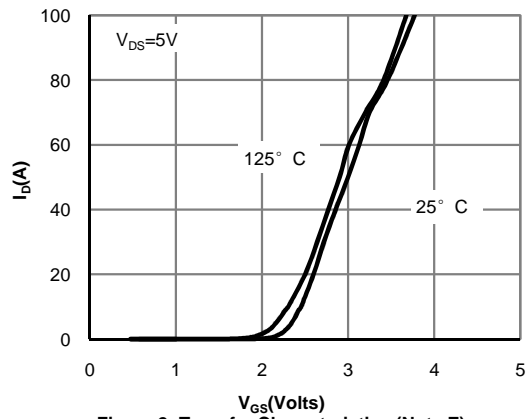
G. These tests are performed with the device mounted on 1 in<sup>2</sup> FR-4 board with 2oz. Copper, in a still air environment with T<sub>A</sub>=25° C.

COMPONENTS IN LIFE SUPPORT DEVICES OR SYSTEMS ARE NOT AUTHORIZED. AOS DOES NOT ASSUME ANY LIABILITY ARISING OUT OF SUCH APPLICATIONS OR USES OF ITS PRODUCTS. AOS RESERVES THE RIGHT TO IMPROVE PRODUCT DESIGN, FUNCTIONS AND RELIABILITY WITHOUT NOTICE.

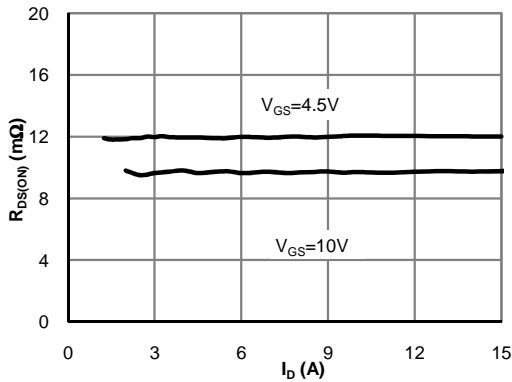
**Q2-CHANNEL: TYPICAL ELECTRICAL AND THERMAL CHARACTERISTICS**



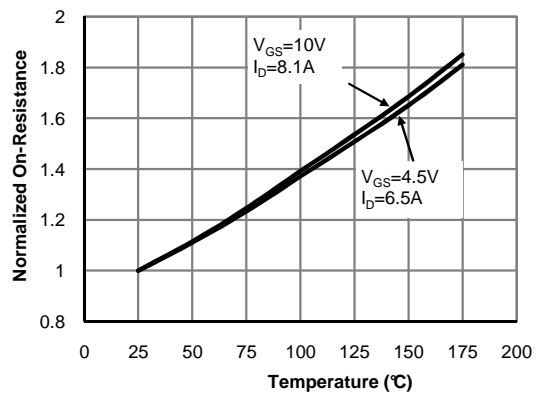
**Figure 1: On-Region Characteristics (Note E)**



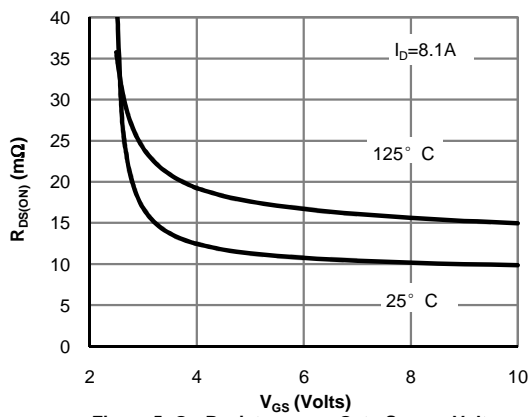
**Figure 2: Transfer Characteristics (Note E)**



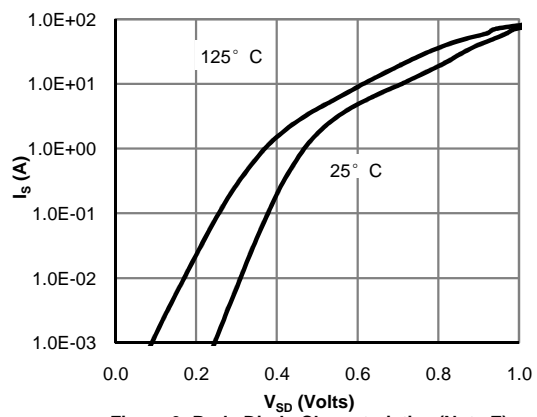
**Figure 3: On-Resistance vs. Drain Current and Gate Voltage (Note E)**



**Figure 4: On-Resistance vs. Junction Temperature (Note E)**

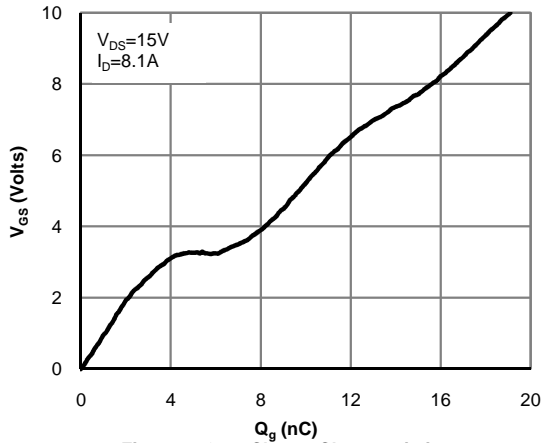


**Figure 5: On-Resistance vs. Gate-Source Voltage (Note E)**

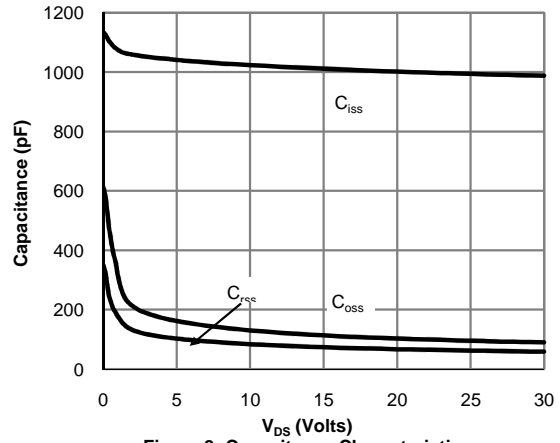


**Figure 6: Body-Diode Characteristics (Note E)**

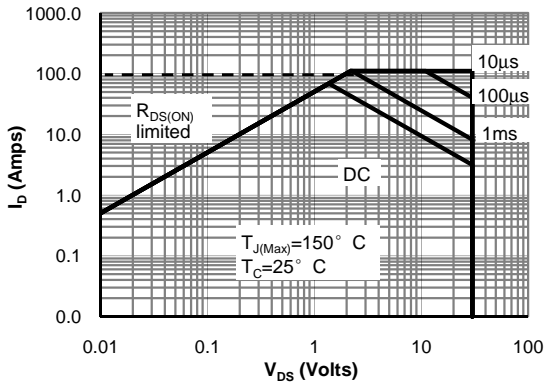
**Q2-CHANNEL: TYPICAL ELECTRICAL AND THERMAL CHARACTERISTICS**



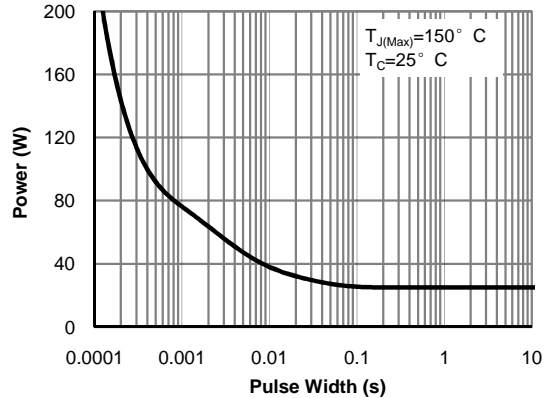
**Figure 7: Gate-Charge Characteristics**



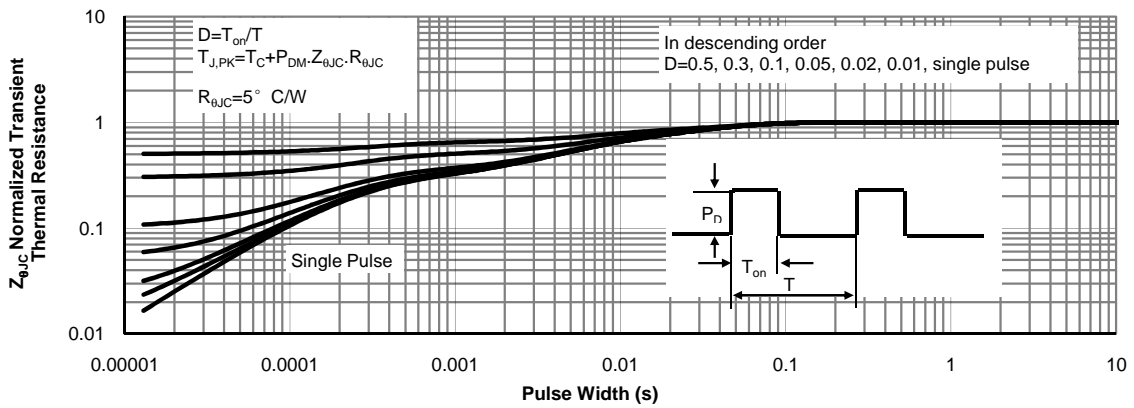
**Figure 8: Capacitance Characteristics**



**Figure 9: Maximum Forward Biased Safe Operating Area (Note F)**



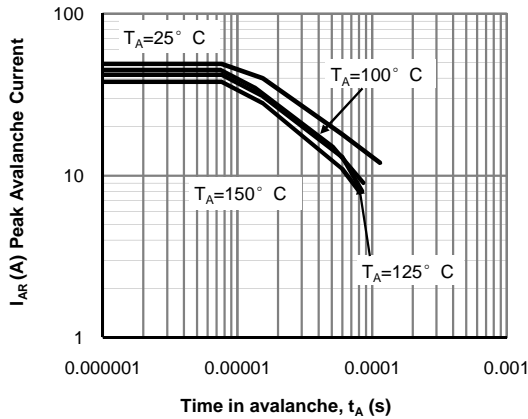
**Figure 10: Single Pulse Power Rating Junction-to-Case (Note F)**



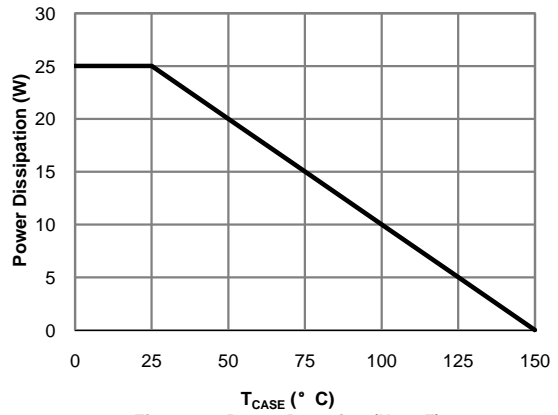
**Figure 11: Normalized Maximum Transient Thermal Impedance (Note F)**



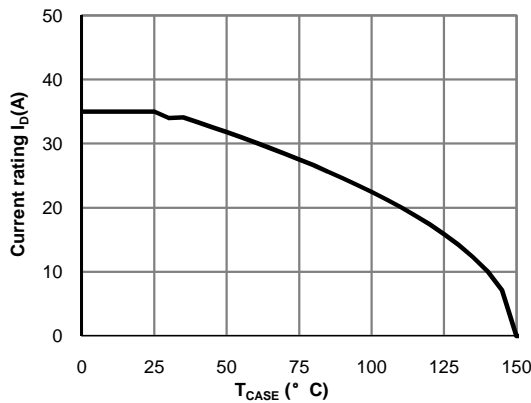
**Q2-CHANNEL: TYPICAL ELECTRICAL AND THERMAL CHARACTERISTICS**



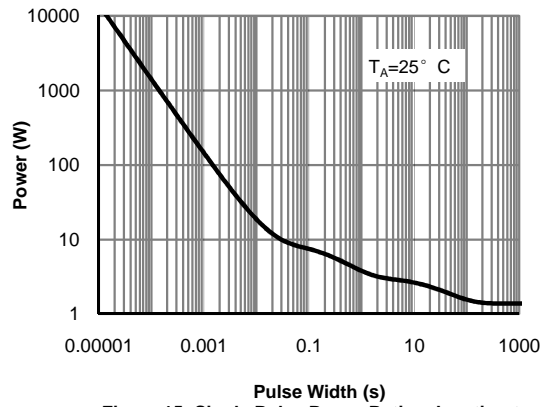
**Figure 12: Single Pulse Avalanche capability (Note C)**



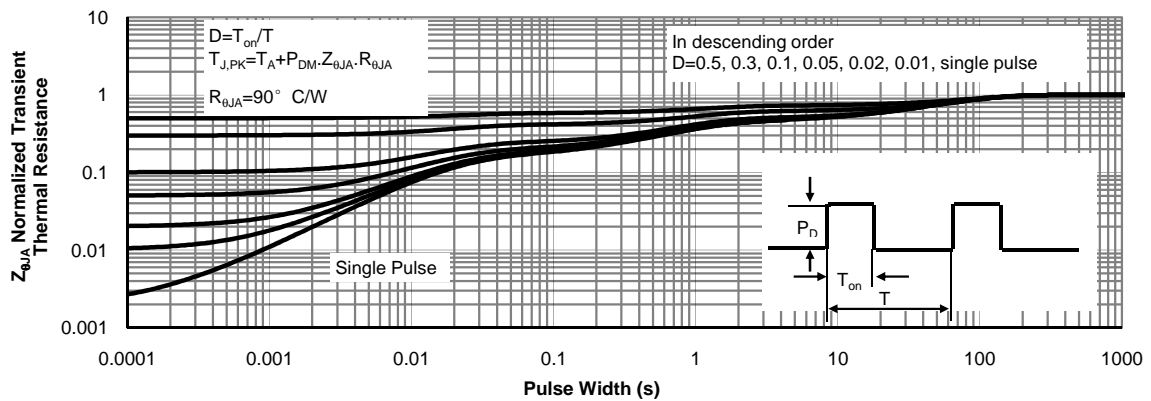
**Figure 13: Power De-rating (Note F)**



**Figure 14: Current De-rating (Note F)**

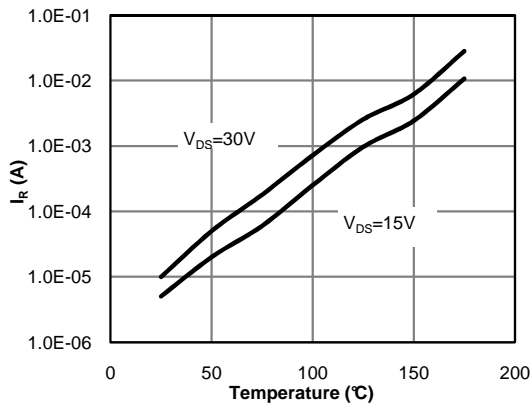


**Figure 15: Single Pulse Power Rating Junction-to-Ambient (Note G)**

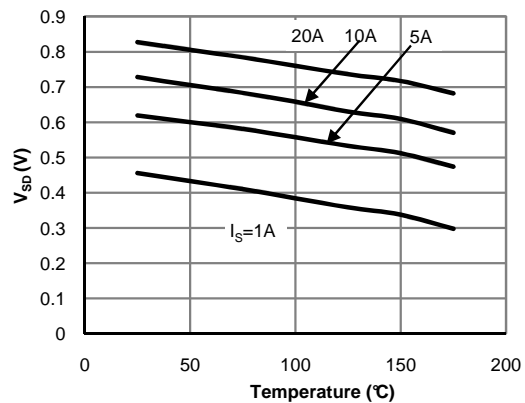


**Figure 16: Normalized Maximum Transient Thermal Impedance (Note G)**

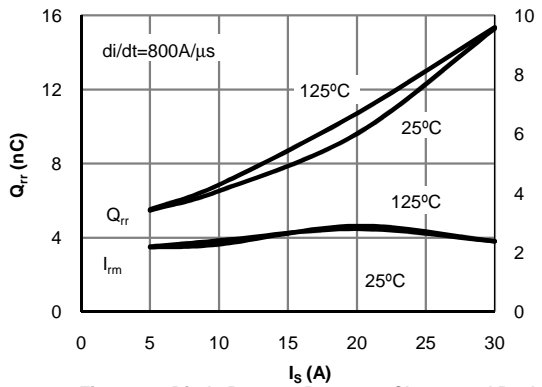
**Q2-CHANNEL: TYPICAL ELECTRICAL AND THERMAL CHARACTERISTICS**



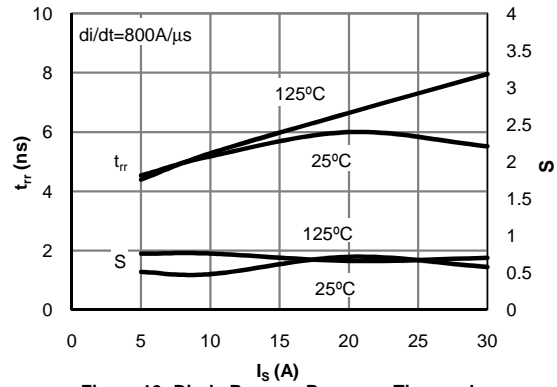
**Figure 17: Diode Reverse Leakage Current vs. Junction Temperature**



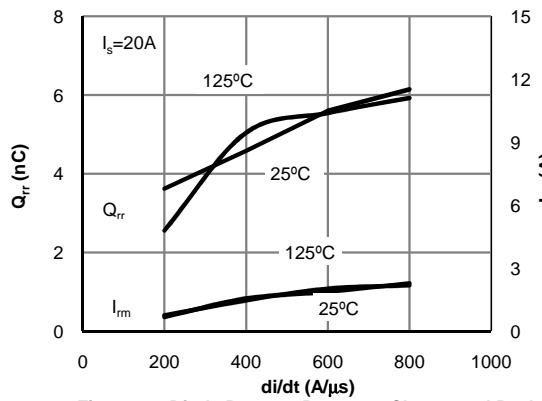
**Figure 18: Diode Forward Voltage vs. Junction Temperature**



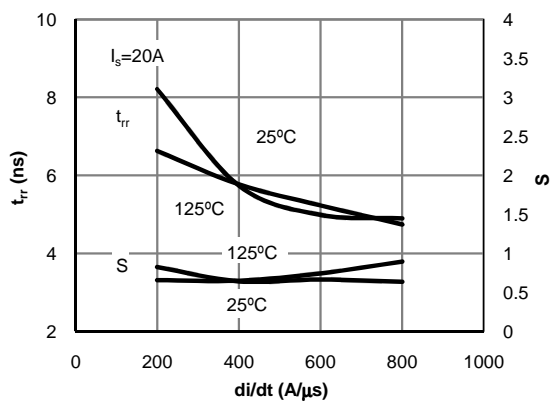
**Figure 18: Diode Reverse Recovery Charge and Peak Current vs. Conduction Current**



**Figure 19: Diode Reverse Recovery Time and Softness Factor vs. Conduction Current**

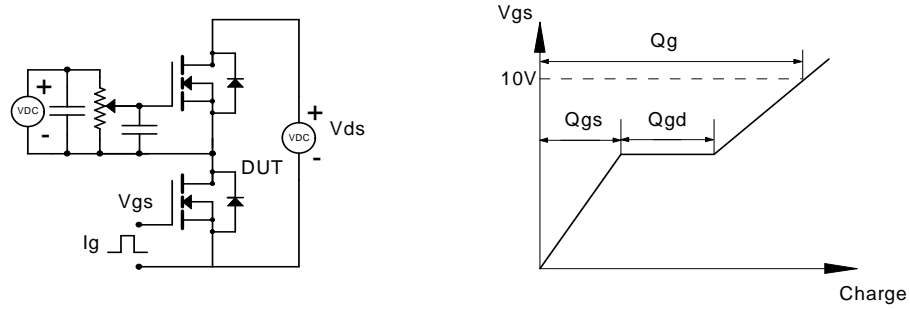


**Figure 20: Diode Reverse Recovery Charge and Peak Current vs. di/dt**

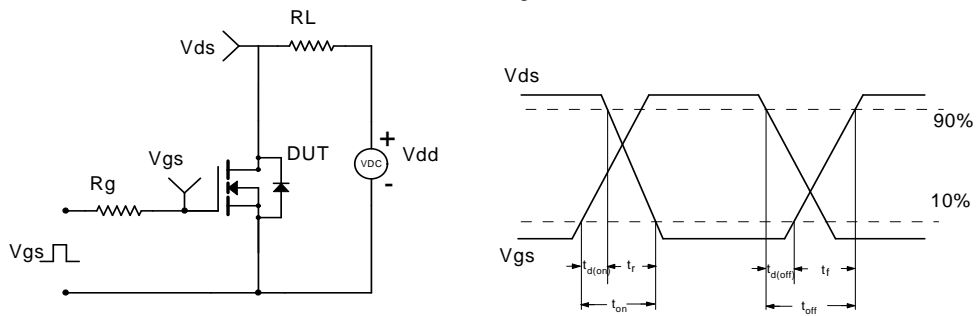


**Figure 21: Diode Reverse Recovery Time and Softness Factor vs. di/dt**

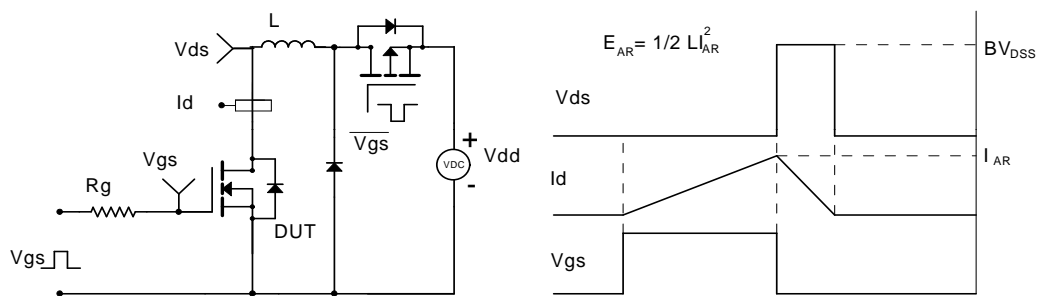
**Gate Charge Test Circuit & Waveform**



**Resistive Switching Test Circuit & Waveforms**



**Unclamped Inductive Switching (UIS) Test Circuit & Waveforms**



**Diode Recovery Test Circuit & Waveforms**

