

3M™ Latch/Eject Header

2 mm x 2 mm Straight & Right Angle, Through-Hole, Straight, Surface Mount

1552 Series



- 14 pin counts ranging from 6 to 50 positions
- Latch/eject mechanism securely latches to socket
- Roll pins retain latches to body in shipping and high vibration environments
- Ejector helps make unmating of cable assemblies easier
- High temperature insulators suitable for lead free processing
- Robust system solution when used with 3M™ IDC Wiremount Sockets or 3M™ Molded Cable Assemblies
- SMT latch/eject headers are available in tape and reel with vacuum cap for automatic placement
- RoHS Compliant. See the Regulatory Information Appendix (RIA) in the “RoHS compliance” section of www.3Mconnectors.com for compliance information (RIA E1 & C1 apply)

Date Modified: June 22, 2012

TS-2199-K
Sheet 1 of 4

Physical

Insulation:

Material: Glass Filled Polyester (LCP)
Flammability: UL 94V-0
Color: Black

Contact:

Material: Copper Alloy

Plating:

Underplating: 50 μ" [1.27 μm] Nickel
Wiping Area: See Ordering Information
Solder Tails: 200 μ" [5.0 μm] Matte Tin
Mating Compatibility 1522, 870, 2M, 2 mm SCI Carrier Series

Electrical

Current Rating: 4.75 A, 1 Line Powered
2.00 A, 6 Adjacent Lines Powered
1.25 A, All Lines Powered

Rating Conditions: EIA-364-070 Method 2, 30°C maximum temperature rise, 20% derated. Reference appropriate 3M Product Specification for detailed current derating curves.

Insulation Resistance: $> 1 \times 10^9 \Omega$ at 500 V_{DC}

Withstanding Voltage: 1,000 V_{RMS} at Sea Level

Environmental

Temperature Rating: -55°C to +105°C

Process Rating: Maximum 260°C (per J-STD-020)

Moisture Sensitivity Level: 1 (per J-STD-020)



Electronic Solutions Division
Interconnect Solutions
<http://www.3Mconnectors.com>

3M is a trademark of 3M Company.
For technical, sales or ordering information call
800-225-5373

3M™ Latch/Eject Header

2 mm x 2 mm Straight & Right Angle, Through-Hole, Straight, Surface Mount

1552 Series

Straight

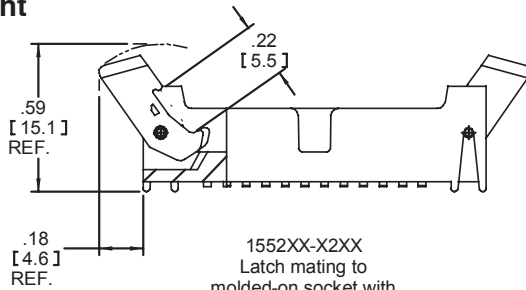

See Chart 1 for latch availability.

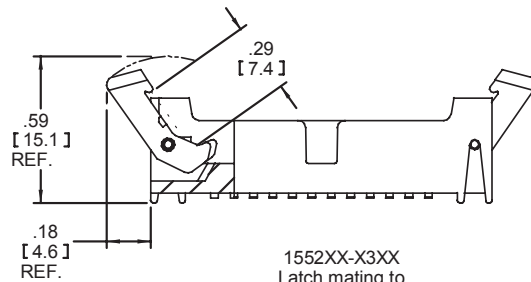

See Chart 1 for latch availability.

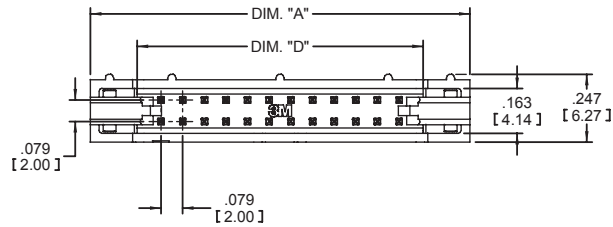
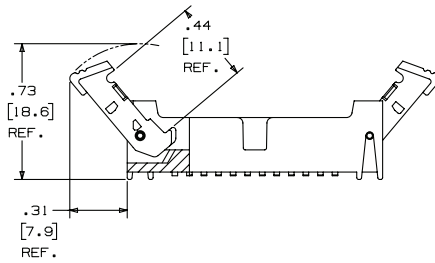

POSITION #1
ORIENTATION
TRIANGLE

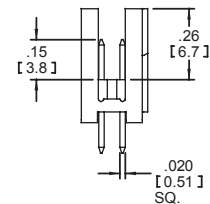
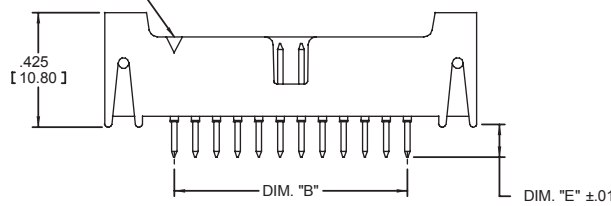

Inch [mm]			
Tolerance Unless Noted			
	.0	.00	.000
Inch	±.1	±.01	±.008

[] Dimensions for Reference Only

PC Board Footprint

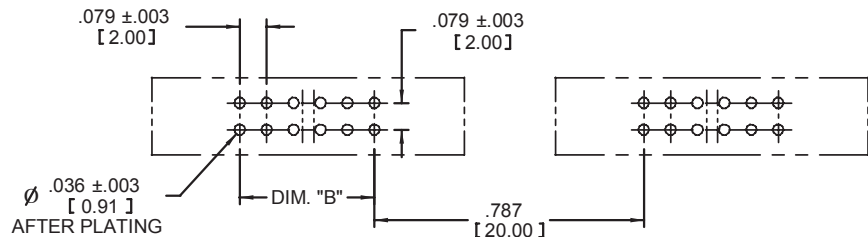

Note: See Chart 1 (sheet 4) for dimensions A, B, D

Ordering Information

1552XX-6X0X-XX

Contact Quantity
(See Table)

Latching:

- 2 = Latch, molded on skt with latching ear, 870, 2M Series
- 3 = Latch, press on skt, 1522 Series
- 4 = Latch, 2 mm SCI Carrier Only

Note: See Chart 1 (sheet 4) for latching availability

Solder Tail Length:
Dimension "E"

- 2 = .112" [2.84]
- 3 = .155" [3.94]

Plating Options:

- RB = 30 μ" [0.76 μm] Gold
- RA = 10 μ" [0.25 μm] Gold
- (RIA E1 & C1 apply) (both platings)

TS-2199-K
Sheet 2 of 4

3M

Electronic Solutions Division
Interconnect Solutions
<http://www.3Mconnectors.com>

3M is a trademark of 3M Company.
For technical, sales or ordering information call
800-225-5373

3M™ Latch/Eject Header

2 mm x 2 mm Straight & Right Angle, Through-Hole, Straight, Surface Mount

1552 Series

Right Angle

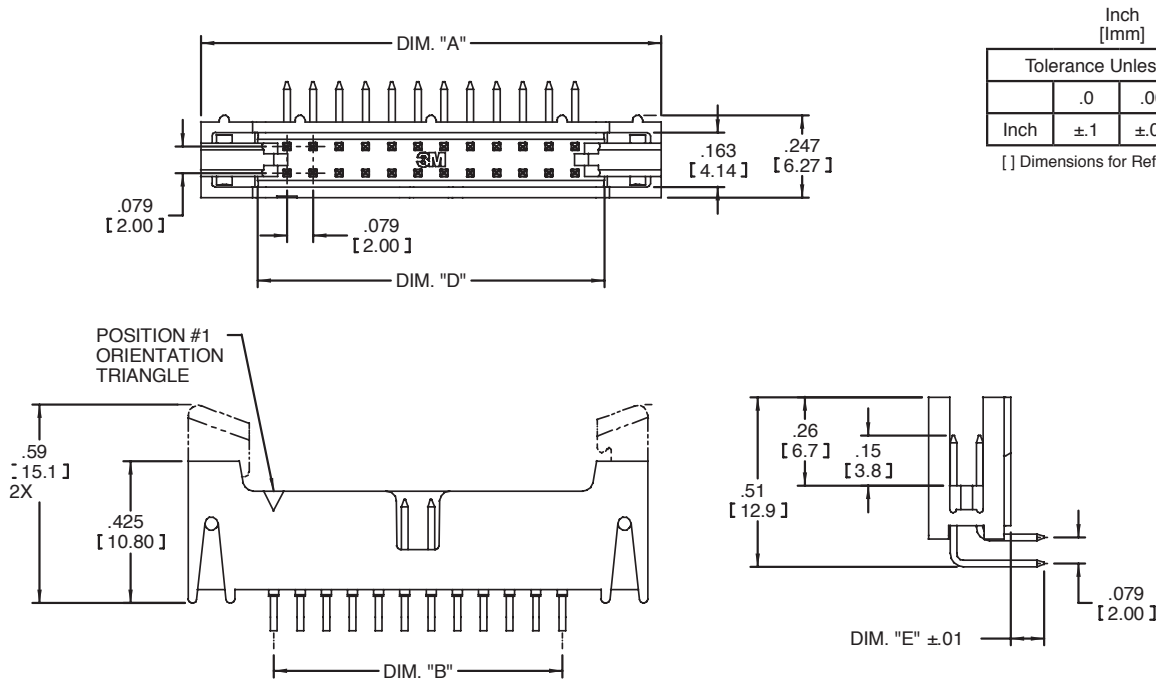

Inch [Imm]			
Tolerance Unless Noted			
	.0	.00	.000
Inch	±.1	±.01	±.008

[] Dimensions for Reference Only

PC Board Footprint

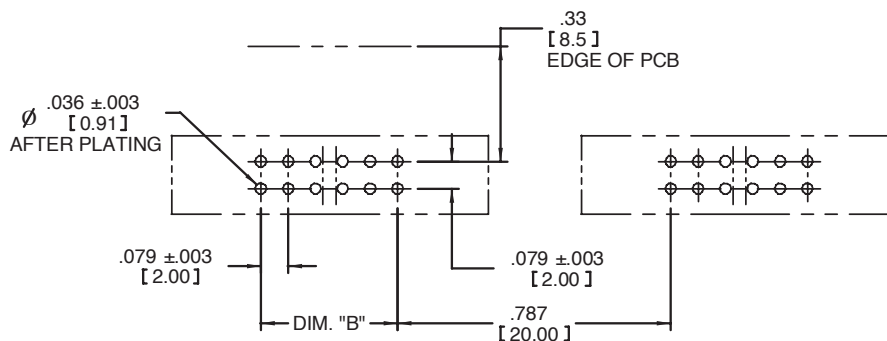

Notes:

1. See straight drawings (sheet 2) for latch dimensions.
2. See Chart 1 (sheet 4) for dimensions A, B, and D.

Ordering Information

1552XX-5X0X-XX

Contact Quantity
(See Table)

Latching:

- 2 = Latch, molded on skt with latching ear, 870, 2M Series
- 3 = Latch, press on skt, 1522 Series
- 4 = Latch, 2 mm, SCI carrier only

Note: See Chart 1 (sheet 4) for latching availability

Solder Tail Length:
Dimension "E"
2 = .112" [2.84]
3 = .155" [3.94]

Plating Options:

- RB = 30 μ" [0.76 μm] Gold
 - RA = 10 μ" [0.25 μm] Gold
- (RIA E1 & C1 apply) (both platings)

TS-2199-K
Sheet 3 of 4



Electronic Solutions Division
Interconnect Solutions
<http://www.3Mconnectors.com>

3M is a trademark of 3M Company.
For technical, sales or ordering information call
800-225-5373

3M™ Latch/Eject Header

2 mm x 2 mm Straight & Right Angle, Through-Hole, Straight, Surface Mount

1552 Series

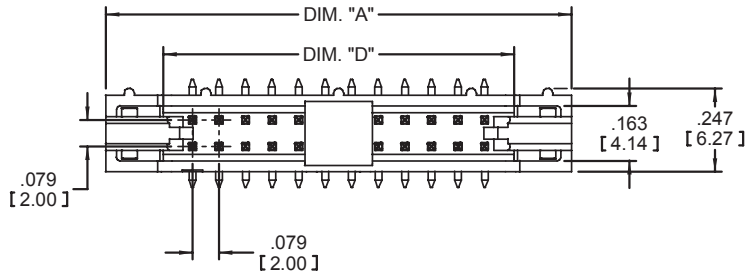

Surface Mount Vertical

Tolerance Unless Noted			
Inch [Imm]			
	.0	.00	.000
Inch	±.1	±.01	±.008

[] Dimensions for Reference Only

POSITION #1
ORIENTATION
TRIANGLE

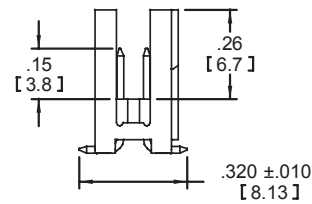
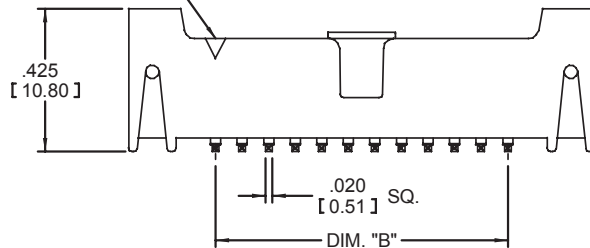
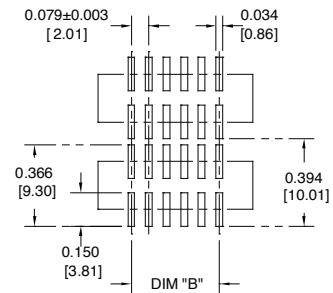

Chart 1

Contact Quantity	Dim. "A" ± 0.008	Dim "B" ± 0.006	Dim "D" ± 0.006	Latch Availability	Tape Width	Order Code
6	.673 [17.09]	.157 [4.00]	.333 [8.45]	2,4	44 mm	WD
8	.752 [19.10]	.236 [6.00]	.411 [10.44]	2,4	44 mm	WD
10	.831 [21.10]	.315 [8.00]	.490 [12.45]	2,3,4	44 mm	WD
12	.910 [23.10]	.394 [10.00]	.569 [14.45]	3,4	44 mm	WD
16	1.067 [27.10]	.551 [14.00]	.726 [18.44]	2,4	56 mm	WE
20	1.224 [31.09]	.709 [18.00]	.884 [22.45]	2,3,4	56 mm	WE
22	1.303 [33.10]	.787 [20.00]	.963 [24.46]	2,4	56 mm	WE
24	1.382 [35.10]	.866 [22.00]	1.041 [26.44]	2,4	56 mm	WE
26	1.461 [37.10]	.945 [24.00]	1.120 [28.45]	2,3,4	72 mm	WF
30	1.618 [41.10]	1.102 [28.00]	1.278 [32.46]	2,4	72 mm	WF
34	1.774 [45.09]	1.260 [32.00]	1.435 [36.46]	2,4	72 mm	WF
40	2.012 [51.10]	1.496 [38.00]	1.671 [42.44]	2,3,4	72 mm	WF
44	2.169 [55.09]	1.654 [42.00]	1.829 [46.46]	2,3,4	88 mm	WG
50	2.405 [61.09]	1.890 [48.00]	2.065 [54.45]	2,3,4	88 mm	WG

PC Board Footprint



Note:

1. See straight drawings (pg 2) for latch dimensions.
2. Tape & reel parts always supplied with pick 'n place surface
3. Tray parts supplied without pick 'n place

- Notes: 1. See straight drawings (sheet 2) for latch dimensions.
 2. See Chart 1 for applicability.
 3. Tape and Reel parts include tape vacuum pick-up cap
 4. Tape and reel not available with SCI latch.

Ordering Information

1552XX-2X00-XX-XX

Contact Quantity
(See Table)

Latching:
 2 = Latch, molded on skt with latching ear, 870, 2M Series
 3 = Latch, press on skt, 1522 Series
 4 = Latch, 2 mm SCI carrier only

Packaging:
 WX = Tape & reel (see table)
 Blank = Trays

Plating Options:
 RB = 30 μ" [0.76 μm] Gold
 RA = 10 μ" [0.25 μm] Gold
 (RIA E1 & C1 apply) (both platings)

TS-2199-K
 Sheet 4 of 4

Important Notice

All statements, technical information, and recommendations related to 3M's products are based on information believed to be reliable, but the accuracy or completeness is not guaranteed. Before using this product, you must evaluate it and determine if it is suitable for your intended application. You assume all risks and liability associated with such use. Any statements related to the product which are not contained in 3M's current publications, or any contrary statements contained on your purchase order shall have no force or effect unless expressly agreed upon, in writing, by an authorized officer of 3M.

Warranty; Limited Remedy; Limited Liability.

This product will be free from defects in material and manufacture for a period of one (1) year from the time of purchase. **3M MAKES NO OTHER WARRANTIES INCLUDING, BUT NOT LIMITED TO, ANY IMPLIED WARRANTY OF MERCHANTABILITY OR FITNESS FOR A PARTICULAR PURPOSE.** If this product is defective within the warranty period stated above, your exclusive remedy shall be, at 3M's option, to replace or repair the 3M product or refund the purchase price of the 3M product. **Except where prohibited by law, 3M will not be liable for any indirect, special, incidental or consequential loss or damage arising from this 3M product, regardless of the legal theory asserted.**

**3M Electronics Solutions Division**

6801 River Place Blvd.
Austin, TX 78726-9000
U.S.A.
1-800-225-5373
www.3Mconnectors.com

Please recycle. Printed in USA.
© 3M 2012. All rights reserved.
RIA-2217B-E

3M is a trademark of 3M Company.

Mouser Electronics

Authorized Distributor

Click to View Pricing, Inventory, Delivery & Lifecycle Information:

3M:

[155206-2200-RB](#) [155206-2300-RB](#) [155206-5203-RB](#) [155206-5302-RB](#) [155206-5303-RB](#) [155206-6202-RB](#)
[155206-6203-RB](#) [155206-6302-RB](#) [155208-2200-RB](#) [155208-2300-RB](#) [155208-5202-RB](#) [155208-5203-RB](#) [155208-5302-RB](#) [155208-5303-RB](#) [155208-6202-RB](#) [155208-6203-RB](#) [155208-6302-RB](#) [155208-6303-RB](#) [155210-2200-RB](#)
[155210-2300-RB](#) [155210-5202-RB](#) [155210-5203-RB](#) [155210-5302-RB](#) [155210-5303-RB](#) [155210-6202-RB](#)
[155210-6203-RB](#) [155210-6302-RB](#) [155210-6303-RB](#) [155212-2200-RB](#) [155212-2300-RB](#) [155212-5202-RB](#) [155212-5203-RB](#) [155212-5302-RB](#) [155212-5303-RB](#) [155212-6202-RB](#) [155212-6203-RB](#) [155212-6302-RB](#) [155212-6303-RB](#)
[155216-2200-RB](#) [155216-2300-RB](#) [155216-5202-RB](#) [155216-5203-RB](#) [155216-5302-RB](#) [155216-5303-RB](#)
[155216-6202-RB](#) [155216-6203-RB](#) [155216-6302-RB](#) [155216-6303-RB](#) [155220-2200-RB](#) [155220-2300-RB](#) [155220-5202-RB](#) [155220-5203-RB](#) [155220-5302-RB](#) [155220-5303-RB](#) [155220-6202-RB](#) [155220-6203-RB](#) [155220-6302-RB](#) [155220-6303-RB](#)
[155220-6303-RB](#) [155222-2200-RB](#) [155222-2300-RB](#) [155222-5202-RB](#) [155222-5203-RB](#) [155222-5302-RB](#)
[155222-5303-RB](#) [155222-6202-RB](#) [155222-6203-RB](#) [155222-6302-RB](#) [155222-6303-RB](#) [155224-2200-RB](#) [155224-2300-RB](#) [155224-5202-RB](#) [155224-5203-RB](#) [155224-5302-RB](#) [155224-5303-RB](#) [155224-6202-RB](#) [155224-6203-RB](#)
[155224-6302-RB](#) [155224-6303-RB](#) [155226-2200-RB](#) [155226-2300-RB](#) [155226-5202-RB](#) [155226-5203-RB](#)
[155226-5302-RB](#) [155226-5303-RB](#) [155226-6202-RB](#) [155226-6203-RB](#) [155226-6302-RB](#) [155226-6303-RB](#) [155206-6303-RB](#) [155206-5202-RB](#) [155230-2200-RB](#) [155230-2300-RB](#) [155230-5202-RB](#) [155230-5203-RB](#) [155230-5302-RB](#) [155230-5303-RB](#) [155230-6202-RB](#) [155230-6203-RB](#) [155230-6302-RB](#) [155230-6303-RB](#)