



For use with TO-220 packages

507102b00000
VIS#001343



Mechanical Outline Drawing

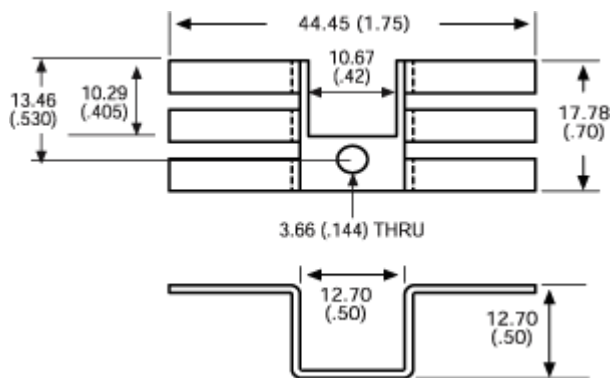

Thermal Resistance	15.6
---------------------------	------

Thermal resistance value is based on a 75°C rise in natural convection

Thermal Curves

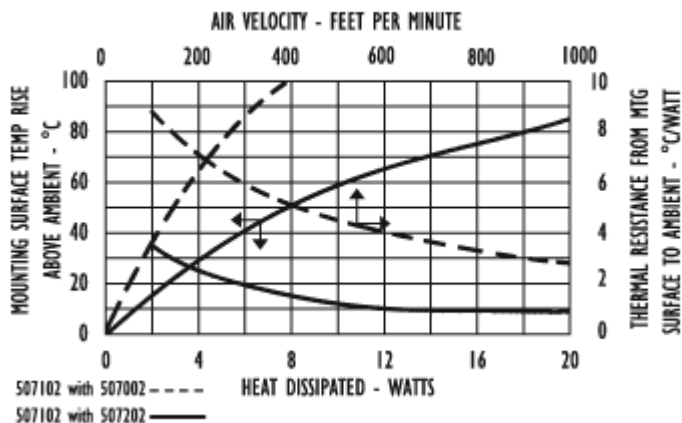

Product Information

12 Digit Part #	Description	Finish	Board Mounting
507102b00000	Heat sink with no added hardware	Black Anodize	N/A

Not Exactly what you need?

We offer several options for those applications which require a more unique solution. For slight modifications of this part or other attachment options, finishes, and interface materials, contact your [local representative](#). Challenge us with your thermal requirements - we can design custom solutions.

For technical help with our Standard Products, please call (603) 223-1921, or contact your local Manufacturer's Rep
 Email: info@aavid.com

Visit us at www.aavidthermalloy.com • ©2002 Aavid Thermalloy, LLC