



AWL6254
 2.4 GHz 802.11b/g/n
 WLAN PA, LNA, and RF Switch
 Data Sheet - Rev 2.0

FEATURES

- 3.3 % EVM @ $P_{OUT} = +16$ dBm with IEEE 802.11g 64 QAM OFDM at 54 Mbps
- 75 mA Transmit Path Current Consumption at $P_{OUT} = +16$ dBm
- SP3T RF Switch to Enable Bluetooth Path
- Single +3.6 V Supply
- Transmit Path Linear Power Gain of 28 dB
- Temperature-Compensated Linear Power Detector with Positive Slope
- Receive Path In-Band Gain of 13 dB
- Receive Path Noise Figure of 2.3 dB
- 3 mm x 3 mm x 0.55 mm ULPCC Package

APPLICATIONS

- 802.11b/g WLAN in Cell Phone Designs
- 802.11n in WLAN MIMO Systems
- 2.4 GHz Cordless Phone Handsets/Basestations

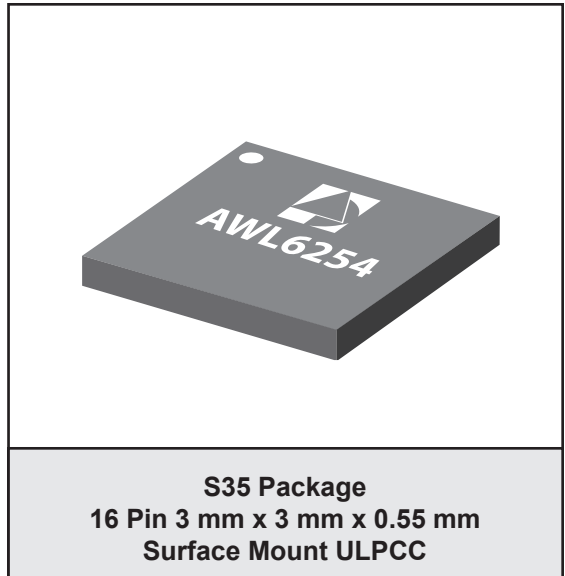

PRODUCT DESCRIPTION

The ANADIGICS AWL6254 is a high performance InGaP HBT power amplifier, low-noise amplifier, and RF switch integrated on a single IC. It is particularly applicable to cell phone designs that integrate 802.11b/g WLAN in the 2.4 - 2.5 GHz band. Matched to 50 Ω on all RF ports, the part requires no additional RF matching components off-chip.

The antenna port is switched between WLAN transmit, WLAN receive, and Bluetooth paths with a low-loss single-pole triple-throw RF switch. The transmit path PA exhibits unparalleled linearity for both IEEE 802.11b/g/n WLAN systems under the toughest signal configurations within these standards. The WLAN receive path from the antenna port to receiver output port provides a low noise, high-gain path to the system receiver chain.

The positive slope power detector is temperature-compensated on the chip, enabling a single-ended output voltage with excellent accuracy over a wide range of operating temperatures. The AWL6254 is biased by a single +3.6 V supply and consumes ultra-low current in the OFF mode.

The AWL6254 is manufactured using advanced InGaP HBT technology that offers state-of-the-art reliability, temperature stability and ruggedness. It is provided in a 3 mm x 3 mm x 0.55 mm ULPCC package optimized for a 50 Ω system.

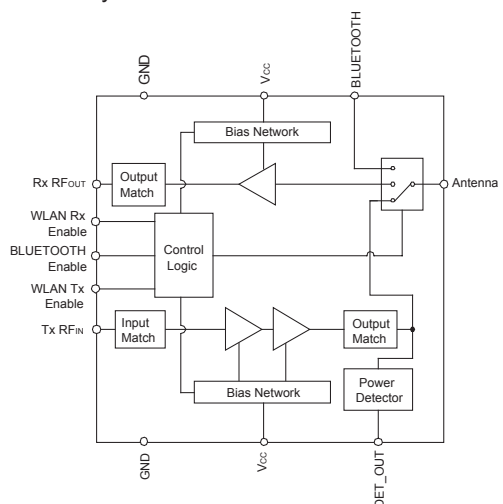

Figure 1: Block Diagram and Pinout

Table 1: Pin Description

PIN	NAME	DESCRIPTION
1	BLUETOOTH	Bluetooth RF Port
2	GND	Ground
3	RX_RF	Receive RF Port
4	GND	Ground
5	LNA_EN	LNA Enable. On/Off control for the Rx path low noise amplifier
6	BT_EN	Bluetooth Enable. On/Off control for the Bluetooth path
7	PA_EN	Power Amplifier Enable. On/Off control for the Tx path power amplifier
8	GND	Ground
9	PA_IN	Power Amplifier Input
10	GND	Ground
11	NC	No Connection
12	V _{CC}	Power Supply. Bias for the transistors in the part
13	DET_OUT	Power Detector Output. DC coupled power detector output. An emitter follower BJT supplies the output for this pin.
14	GND	Ground
15	ANT	Antenna Port. Common connection for the PA, LNA, and Bluetooth paths
16	GND	Ground

ELECTRICAL CHARACTERISTICS

Table 2: Absolute Minimum and Maximum Ratings

PARAMETER	MIN	MAX	UNIT	COMMENTS
DC Power Supply Voltage (V_{CC})	-	+5.0	V	No RF Signal Applied
DC Power Control Voltage (V_{PA_EN})	-	+5.0	V	No RF Signal Applied
DC Power Control Voltage (V_{LNA_EN})	-	+5.0	V	No RF Signal Applied
DC Power Control Voltage (V_{BT_EN})	-	+5.0	V	No RF Signal Applied
DC Current Consumption	-	300	mA	
Tx RF Input Level (RF_{IN})	-	0	dBm	
Ant RF Input Level (RF_{IN})	-	-3	dBm	
Bluetooth RF Input Level (RF_{IN})	-	23	dBm	
Storage Case Temperature	-55	+150	°C	
Operating Case Temperature	-40	+85	°C	
ESD Tolerance	500	-	VDC	All pins, forward and reverse voltage. Human Body Model (HBM)
MSL Rating	-	MSL-2		
Reflow Temperature	-	260	°C	

Stresses in excess of the absolute ratings may cause permanent damage. Functional operation is not implied under these conditions. Exposure to absolute ratings for extended periods of time may adversely affect reliability.

Table 3: Operating Ranges

PARAMETER	MIN	TYP	MAX	UNIT	COMMENTS
Operating Frequency (f)	2400	-	2500	MHz	
DC Power Supply Voltage (V_{CC})	+3.3	+3.6	+4.2	V	
Control Voltage (V_{PA_EN} , V_{LNA_EN} , V_{BT_EN})	+2.0 0	+3.3 -	+4.2 +0.4	V	PA "ON" PA "SHUTDOWN"
Case Temperature (T_c)	-40	-	+85	°C	
Control Pin Impedance (V_{PA_EN} , V_{LNA_EN} , V_{BT_EN})	-	720	-	k Ω	

The device may be operated safely over these conditions; however, parametric performance is guaranteed only over the conditions defined in the electrical specifications.

Table 4: DC Electrical Specifications - Tx Path Continuous Wave
($T_C = +25\text{ }^\circ\text{C}$, $V_{CC} = +3.6\text{ V}$, $V_{PA_EN} = +3.3\text{ V}$, $V_{LNA_EN} = 0\text{ V}$, $V_{BT_EN} = 0\text{ V}$)

PARAMETER	MIN	TYP	MAX	UNIT	COMMENTS
P1dB	20	22	-	dBm	
Current at P1dB	140	175	210	mA	
Shutdown Current	-	25	75	μA	Shutdown Mode
Quiescent Current	18	26	34	mA	$V_{CC} = +3.6\text{ V}$, $V_{PA_EN} = +3.3\text{ V}$, $V_{LNA_EN} = 0\text{ V}$, $V_{BT_EN} = 0\text{ V}$, RF = off
Harmonics 2fo 3fo	- - -	-48 -68	-40 -60	dBc	$P_{OUT} = +18\text{ dBm}^{(1)}$
Input Return Loss, Tx RF_{IN}	-	-7	-3	dB	
Output Return Loss, Antenna Port, Switch in Transmit Mode	-	-9	-4	dB	Switch in Tx Position
Reverse Isolation (Antenna Port to Tx Input Port)	30	40	-	dB	Switch in Tx Position, signal injected into Antenna port and measured at Tx input port, PA = "ON"
Stability (Spurious)	-	-60	-50	dBc	6:1 VSWR, $P_{OUT} = +18\text{ dBm}^{(1)}$, $-40\text{ }^\circ\text{C}$
T_{ON} Settling Time	-	1.0	2.0	μs	10% to 90% of maximum RF power. $P_{OUT} = +16\text{ dBm}^{(1)}$

Note:

(1) Power as measured at Antenna port of AWL6254.

Table 5: Electrical Specifications - Tx Path 802.11g**(T_C = +25 °C, V_{CC} = +3.6 V, V_{PA_EN} = +3.3 V, V_{LNA_EN} = 0 V, V_{BT_EN} = 0 V, 64 QAM OFDM 54 Mbps)**

PARAMETER	MIN	TYP	MAX	UNIT	COMMENTS
Operating Frequency	2400	-	2500	MHz	
Power Gain	25	28	32	dB	
Gain Ripple	-	± 1.5	± 2.0	dB	Across 100 MHz band
Error Vector Magnitude (EVM)	-	3.3	5.0	%	P _{OUT} = +16 dBm ^{(1), (2)}
	-	-29.6	-26	dB	
Tx Spectrum Mask	Pass	-	-	N/A	P _{OUT} = +16 dBm ⁽²⁾
Current Consumption	60	75	95	mA	P _{OUT} = +16 dBm ⁽²⁾
Power Detector Voltage	650	780	900	mV	P _{OUT} = +16 dBm ⁽²⁾
Power Detector Sensitivity	50	68	85	mV/dB	10 dBm < P _{OUT} < +17 dBm ⁽²⁾

Note:

(1) EVM includes system noise floor of 1% (-40 dB).

(2) Power as measured at Antenna port of AWL6254

Table 6: Electrical Specifications - Tx Path 802.11b**(T_C = +25 °C, V_{CC} = +3.6 V, V_{PA_EN} = +3.3 V, V_{LNA_EN} = 0 V, V_{BT_EN} = 0 V, 1 Mbps, Gaussian Filtering, bT=0.50)**

PARAMETER	MIN	TYP	MAX	UNIT	COMMENTS
Operating Frequency	2400	-	2500	MHz	
Power Gain	25	28	32	dB	
Gain Ripple	-	± 1.5	± 2.0	dB	Across 100 MHz band
Adjacent Channel Power (ACPR) 1st Sidelobe (11 - 22 MHz Offset)	-	-33	-30	dBr	P _{OUT} = +18 dBm ⁽¹⁾
Adjacent Channel Power (ACPR) 2nd Sidelobe (>22 MHz Offset)	-	-53	-50	dBr	P _{OUT} = +18 dBm ⁽¹⁾
Tx Spectrum Mask	Pass	-	-	N/A	P _{OUT} = +18 dBm ⁽¹⁾
Current Consumption	75	100	125	mA	P _{OUT} = +18 dBm ⁽¹⁾
Power Detector Voltage	810	970	1115	mV	P _{OUT} = +18 dBm ⁽¹⁾
Power Detector Sensitivity	60	78	95	mV/dB	10 dBm < P _{OUT} < +20 dBm ⁽¹⁾

Note:

(1) Power as measured at Antenna port of AWL6254

Table 7: DC Electrical Specifications - Rx Path Continuous Wave
 (T_C = +25 °C, V_{CC} = +3.6 V, V_{PA_EN} = 0 V, V_{LNA_EN} = +3.3 V, V_{BT_EN} = 0 V)

PARAMETER	MIN	TYP	MAX	UNIT	COMMENTS
Power Gain	10	13	16	dB	
Gain Ripple	-	±0.5	±1.0	dB	Across 100 MHz Band
P1dB	4	6	-	dBm	
Current at P1dB	9	13	17	mA	
Quiescent Current	9	13	17	mA	
Noise Figure	-	2.3	3.9	dB	Includes RF switch and LNA
Return Loss, Rx RF Port	-	-12	-8	dB	Switch in Rx position, Antenna port terminated in 50 Ω load
Return Loss, Antenna Port, Switch in Receive Mode	-	-7	-3	dB	Switch in Rx position, with 50 Ω Rx port load
Isolation (Antenna Port to Rx Port)	22	29	-	dB	Switch in Tx position, signal injected into Antenna port and measured at Rx port, PA = "ON"
S21 Performance (@ 1.9 GHz)	-	-6	0	dB	
Stability	-	-60	-50	dBc	

Table 8: DC Electrical Specifications - Bluetooth Path Continuous Wave
 (T_c = +25 °C, V_{CC} = +3.6 V, V_{PA_EN} = 0 V, V_{LNA_EN} = 0 V, V_{BT_EN} = +3.3 V)

PARAMETER	MIN	TYP	MAX	UNIT	COMMENTS
Insertion Loss	-	0.8	1.5	dB	2.4 GHz to 2.5 GHz
Quiescent Current	-	60	125	μA	
P1dB	20	25	-	dBm	
Return Loss, Bluetooth RF Port	-	-10	-8	dB	Switch in Bluetooth position, Antenna port terminated in 50 Ω load
Return Loss, Antenna Port, Switch in Bluetooth Mode	-	-10	-8	dB	Switch in Bluetooth position, Bluetooth port terminated in 50 Ω load
Isolation (Antenna Port to Rx Port)	30	38	-	dB	Switch in Bluetooth position, signal injected into Antenna port and measured at Rx port

Table 9: Control Logic Truth Table

FEIC MODE	PA ENABLE	BLUETOOTH ENABLE	LNA ENABLE	PA STATUS	LNA STATUS	SWITCH STATUS
Shutdown	0	0	0	Off	Off	Not Connected
WLAN Rx	0	0	1	Off	On	WLAN Rx
Bluetooth	0	1	0	Off	Off	Bluetooth
WLAN Tx	1	0	0	On	Off	WLAN Tx

Note:

1. Logic State 0 = 0 - 0.4 V; Logic State 1 = 2.0 - 4.2 V

Table 10: Control Voltages and Timing
 (T_c = +25 °C, V_{CC} = +3.6 V, Other Voltages Defined by Logic Below)

PARAMETER	MIN	TYP	MAX	UNIT	COMMENTS
LNA Enable Pin Control Voltage	+2.0 -	- -	- +0.4	V	LNA = 1 LNA = 0
Bluetooth Enable Pin Control Voltage	+2.0 -	- -	- +0.4	V	Switch = 1 Switch = 0
PA Enable Pin Control Voltage	+2.0 -	- -	- +0.4	V	PA = 1 PA = 0

Note:

1. Logic State 0 = 0 - 0.4 V; Logic State 1 = 2.0 - 4.2 V

PERFORMANCE DATA

Figure 2: Tx Path Gain and Icc vs. Output Power Across Freq ($V_{CC} = +3.6\text{ V}$, $T_A = +25^\circ\text{C}$) 802.11g 54 Mbps OFDM

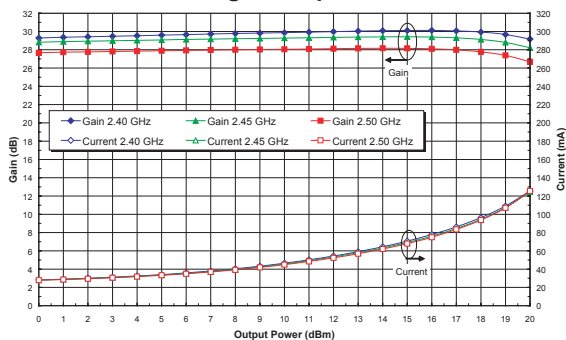

Figure 3: Path Gain and Icc vs. Output Power Across Temp (Freq = 2.45 GHz, $V_{CC} = +3.6\text{ V}$) 802.11g 54 Mbps OFDM

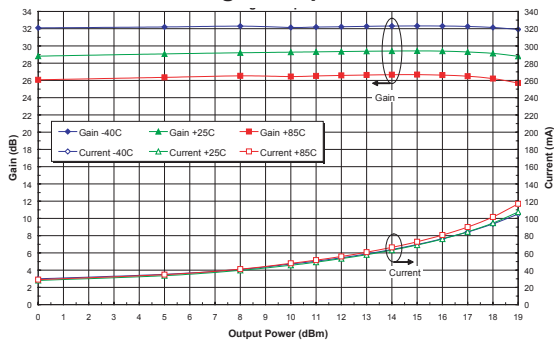

Figure 4: Tx Path Gain and Icc vs. Output Power Across Power Supply Voltage (Freq = 2.45 GHz, $T_A = +25^\circ\text{C}$) 802.11g 54 Mbps OFDM

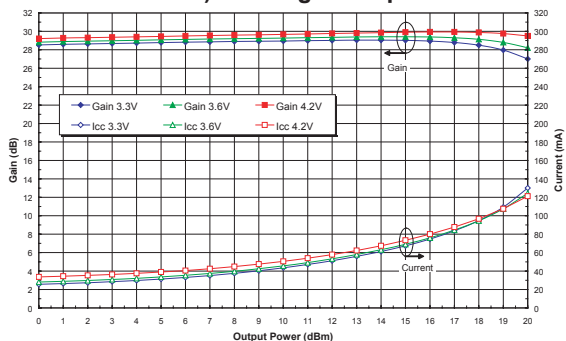

Figure 5: Tx Path EVM vs. Output Power Across Freq ($V_{CC} = +3.6\text{ V}$, $T_A = +25^\circ\text{C}$) 802.11g 54 Mbps OFDM

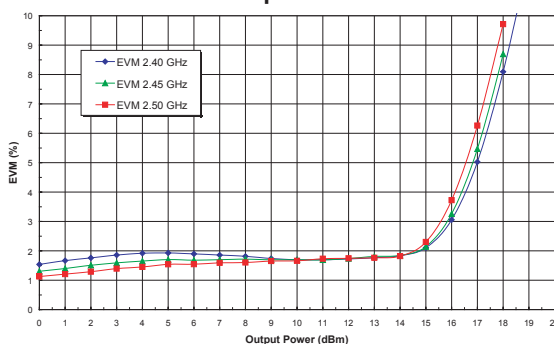

Figure 6: Tx Path EVM vs. Output Power Across Temp (Freq = 2.45 GHz, $V_{CC} = +3.6\text{ V}$) 802.11g 54 Mbps OFDM

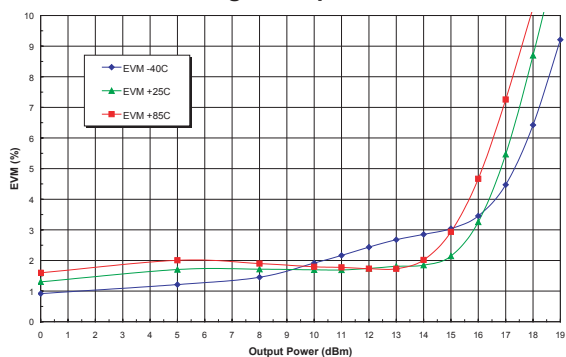

Figure 7: Tx Path EVM vs. Output Power Across Power Supply Voltage (Freq = 2.45 GHz, $T_A = +25^\circ\text{C}$) 802.11g 54 Mbps OFDM

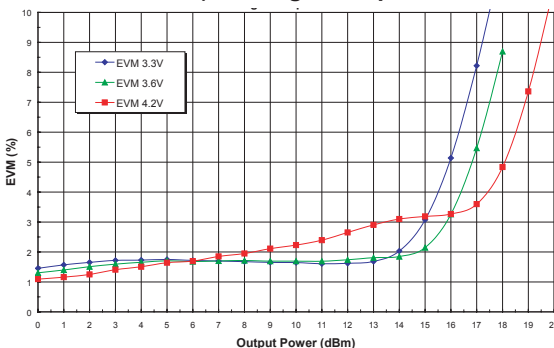

Figure 8: Tx Path Detector Voltage vs. Output Power Across Freq ($T_A = +25^\circ\text{C}$, $V_{CC} = +3.6\text{ V}$) 802.11g 54 Mbps OFDM

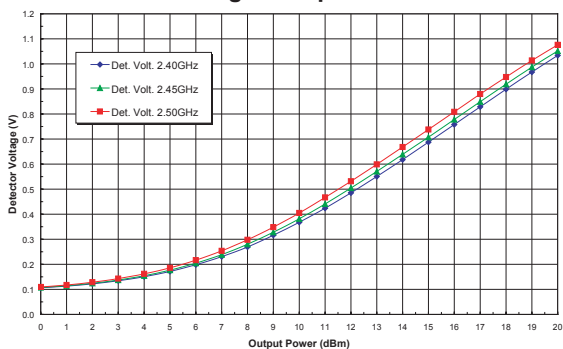

Figure 9: Tx Path Detector Voltage vs. Output Power Across Temp (Freq = 2.45 GHz, $V_{CC} = +3.6\text{ V}$) 802.11g 54 Mbps OFDM

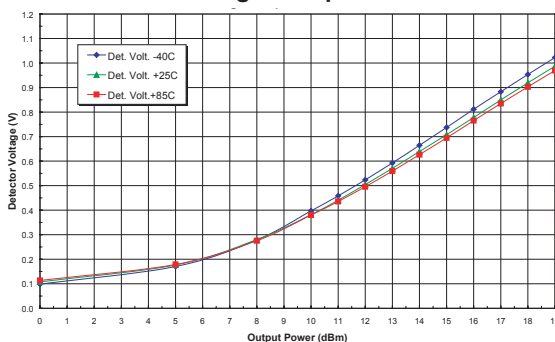

Figure 10: Tx Path Detector Voltage vs. Output Power Across Supply Voltage (Freq = 2.45 GHz, $T_A = +25^\circ\text{C}$) 802.11g 54 Mbps OFDM

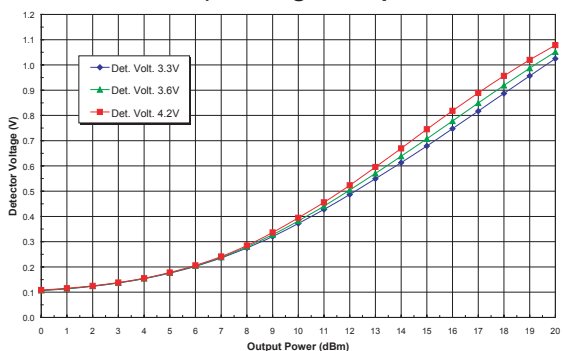

Figure 11: Tx Path and I_{CC} vs. Output Power Across Freq ($T_A = +25^\circ\text{C}$, $V_{CC} = +3.6\text{ V}$) 802.11b Gaussian Filtering (bT=0.5), 1 Mbps

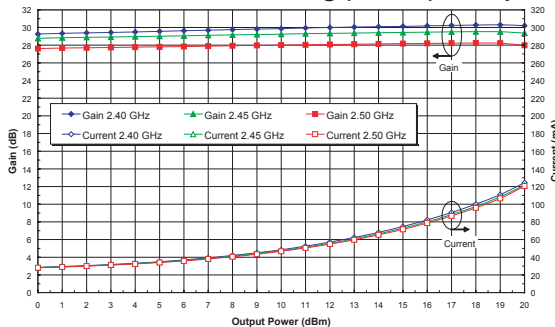

Figure 12: Tx Path Gain and I_{CC} vs. Output Power Across Temp (Freq = 2.45 GHz, $V_{CC} = +3.6\text{ V}$) 802.11b Gaussian Filtering (bT=0.5), 1 Mbps

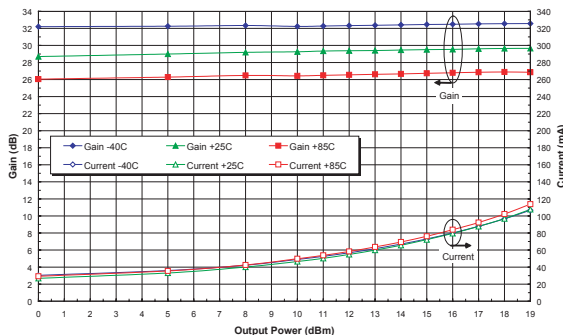

Figure 13: Tx Path Gain and I_{CC} vs. Output Power Across Supply Voltage (Freq=2.45 GHz, $T_A = +25^\circ\text{C}$) 802.11b Gaussian Filtering (bT=0.5), 1 Mbps

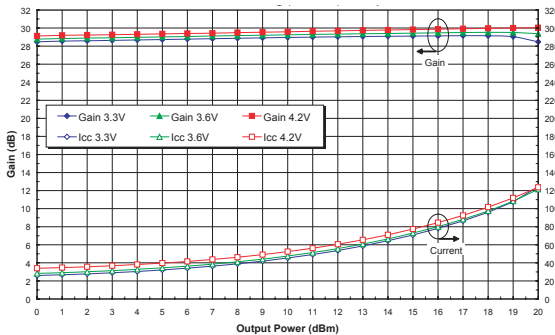

Figure 14: Tx Path ACPR Sidelobes 1 & 2 vs. Output Power Across Freq ($V_{CC} = +3.6\text{ V}$, $T_A = +25^\circ\text{C}$) 802.11b Gaussian Filtering ($bT=0.5$), 1 Mbps

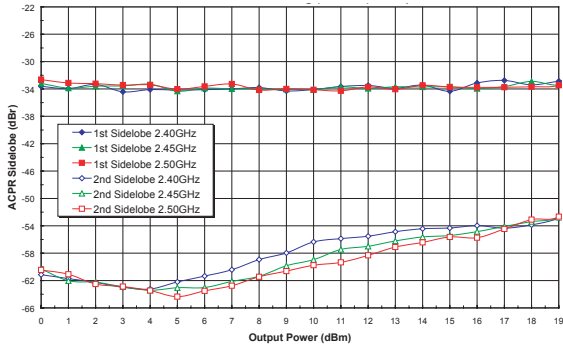

Figure 15: Tx Path ACPR Sidelobes 1 & 2 vs. Output Power Across Temp (Freq = 2.45 GHz, $V_{CC} = +3.6\text{ V}$) 802.11b Gaussian Filtering ($bT=0.5$), 1 Mbps

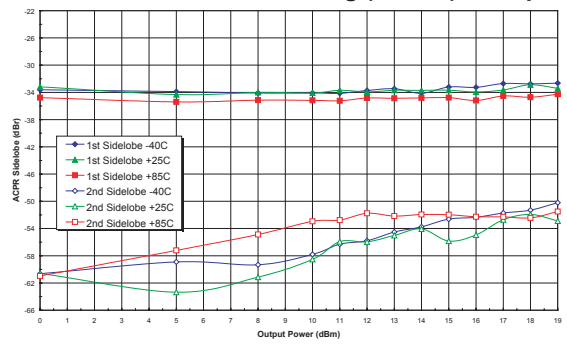

Figure 16: Tx Path ACPR Sidelobes 1 & 2 vs. Output Power Across Supply Voltage (Freq = 2.45 GHz, $T_A = +25^\circ\text{C}$) 802.11b Gaussian Filtering ($bT=0.5$), 1 Mbps

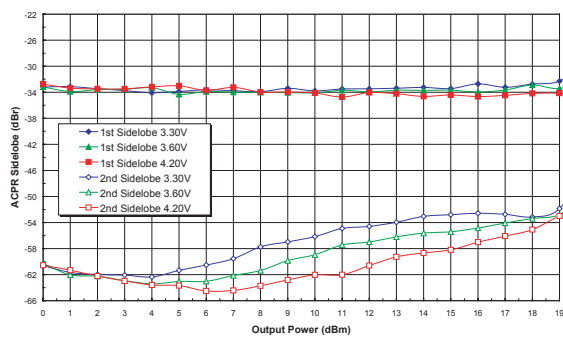

Figure 17: Tx Path Detector Voltage vs. Output Across Freq ($V_{CC} = +3.6\text{ V}$, $T_A = +25^\circ\text{C}$) 802.11b Gaussian Filtering ($bT=0.5$), 1 Mbps

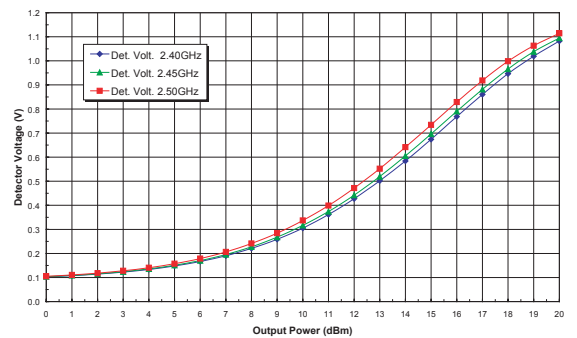

Figure 18: Tx Path Detector Voltage vs. Output Across Temp (Freq = 2.45 GHz, $V_{CC} = +3.6\text{ V}$) 802.11b Gaussian Filtering ($bT=0.5$), 1 Mbps

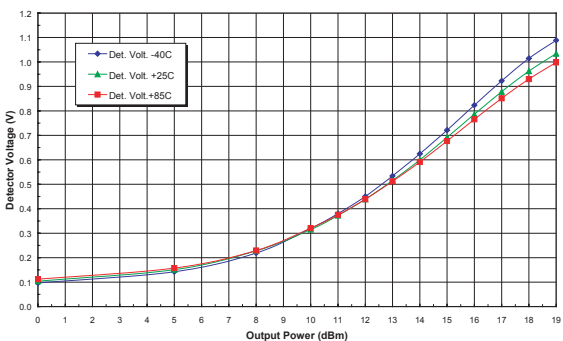

Figure 19: Tx Path Detector Voltage vs. Output Across Supply Voltage (Freq = 2.45 GHz, $T_A = +25^\circ\text{C}$) 802.11b Gaussian Filtering ($bT=0.5$), 1 Mbps

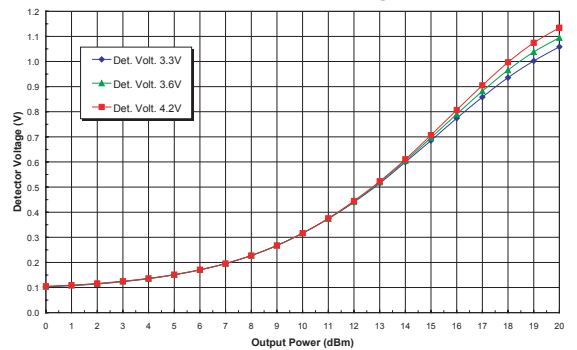

Figure 20: Tx Path S-Parameters S21 Response (V_{CC} = +3.6 V, T_A = +25°C)

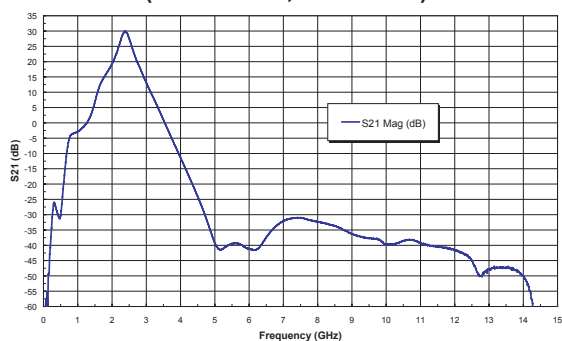

Figure 21: Tx Path S-Parameters S11 & S22 Response (V_{CC} = +3.6 V, T_A = +25°C)

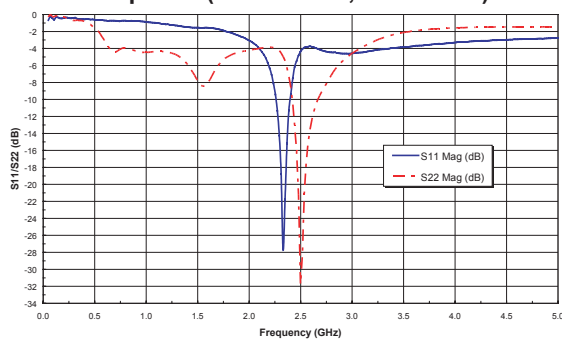

Figure 22: Receive Path Noise Figure Across Supply Voltage (V_{LNA_EN}=+3.3 V, T_A = +25°C)

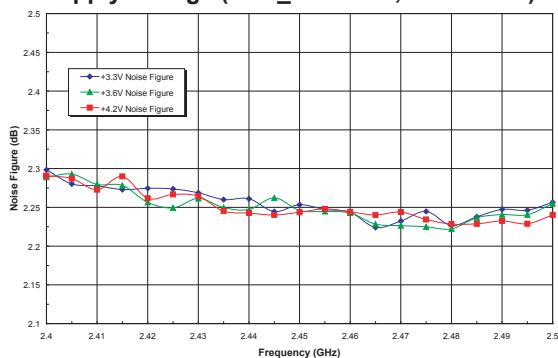

Figure 23: Receive Path Output P1dB Across Freq (V_{CC} = +3.6 V, V_{LNA_EN}=+3.3 V, T_A = +25°C)

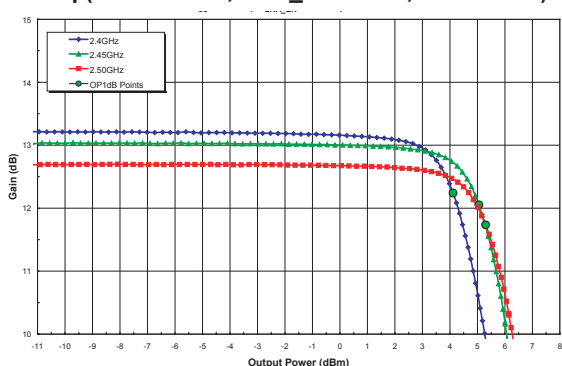

Figure 24: Receive Path Output P1dB Across Supply Voltage (Freq =2.45 GHz, V_{LNA_EN}=+3.3 V, T_A = +25°C)

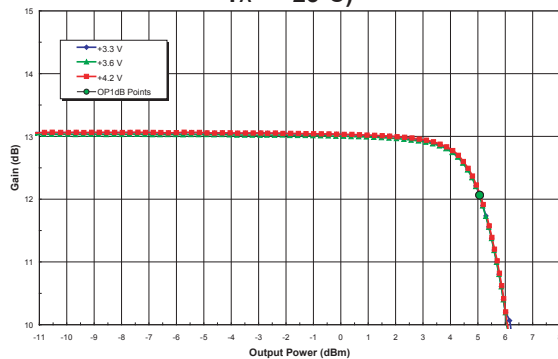

Figure 25: Rx Path S-Parameters S21 Response (V_{CC} = +3.6 V, T_A = +25°C)

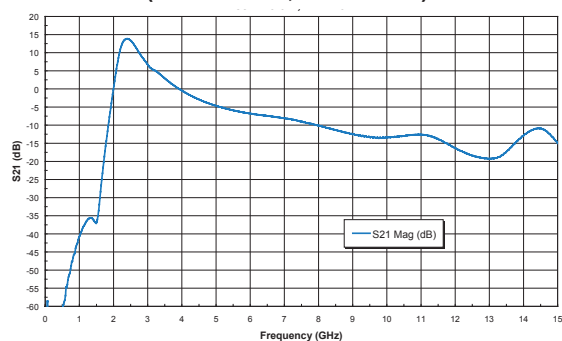

Figure 26: Rx Path S-Parameters S21 & S22 Response (V_{CC} = +3.6 V, T_A = +25°C)

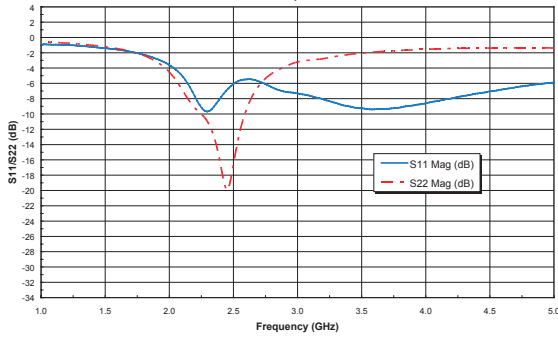

Figure 27: Bluetooth S-Parameters S21 Response (V_{CC} = +3.6 V, T_A = +25°C)

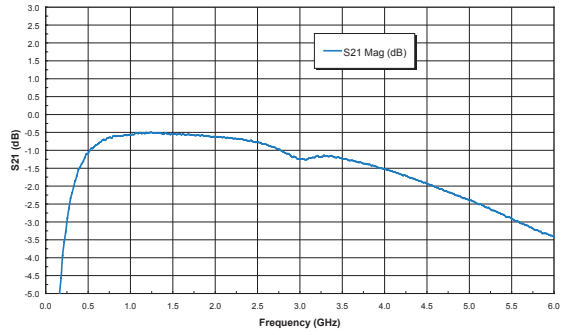
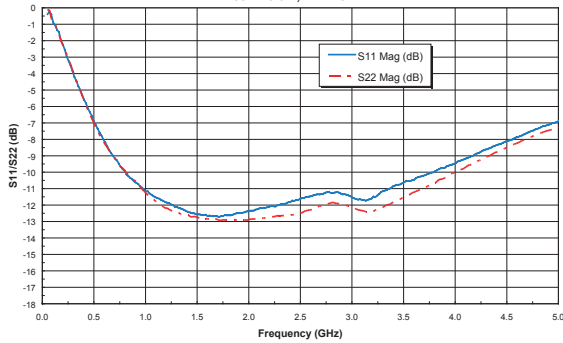

Figure 28: Bluetooth S-Parameters S11 & S22 Response (V_{CC} = +3.6 V, T_A = +25°C)



APPLICATION INFORMATION

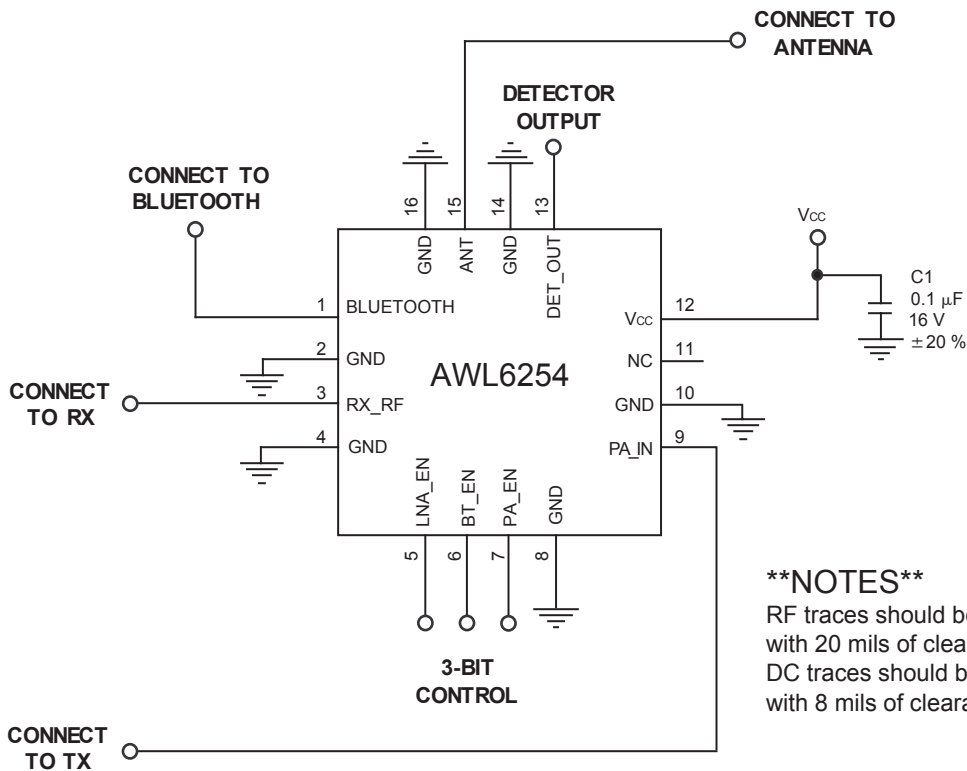
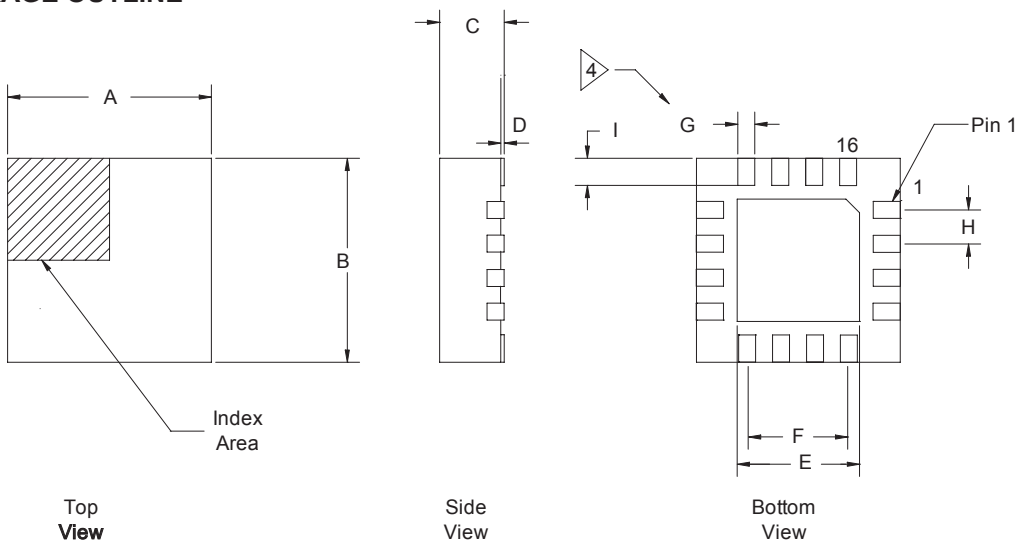

Figure 29: Application Circuit

PACKAGE OUTLINE



DIMENSION	MILLIMETERS		
	MIN	TYP	MAX
A	2.90	3.00	3.10
B	2.90	3.00	3.10
C	0.50	0.55	0.60
D	0.00	0.02	0.05
E	1.55	1.70	1.85
F	1.50 BSC.		
G	0.18	0.25	0.30
H	0.50 BSC.		
I	0.20	0.30	0.40

1. All dimensions are in millimeters, angles in degrees.
2. The terminal #1 identifier and pad numbering convention shall conform to JESD 95-1 SPP-012
3. Lead coplanarity: 0.05 max.
4. Dimension applies to metalized pad and is measured between 0.25 and 0.30 MM from pad tip.

Figure 30: S35 Package Outline - 16 Pin 3 mm x 3 mm x 0.55 mm ULPC

TOP BRAND

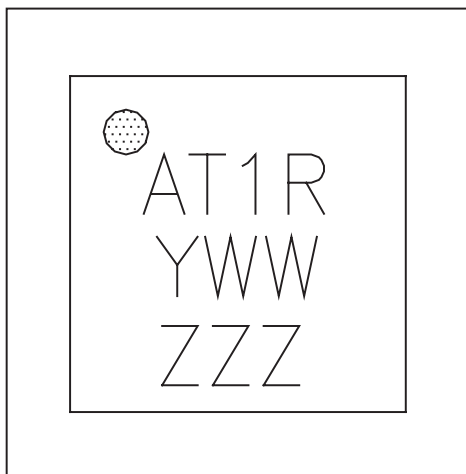

NOTES:

1. ANADIGICS LOGO SIZE: N/A
2. PART NUMBER: AT = 2 DIGIT PART NUMBER
1 = CURRENT ISSUE NUMBER OF BOM.
R = ROHS COMPLIANCE.
3. YEAR AND WORK WEEK: YWW = LAST DIGIT OF YEAR, TWO DIGIT WORK WEEK.
4. LOT NUMBER: ZZZ = LAST THREE NUMBERS OF WAFER LOT NUMBER
5. PIN 1 INDICATOR: MOLD NOTCH -or- INK DOT
6. COUNTRY CODE: N/A
7. TYPE : ELITE
SIZE : 1.5-POINT
COLOR : LASER

Figure 31: Branding Specification

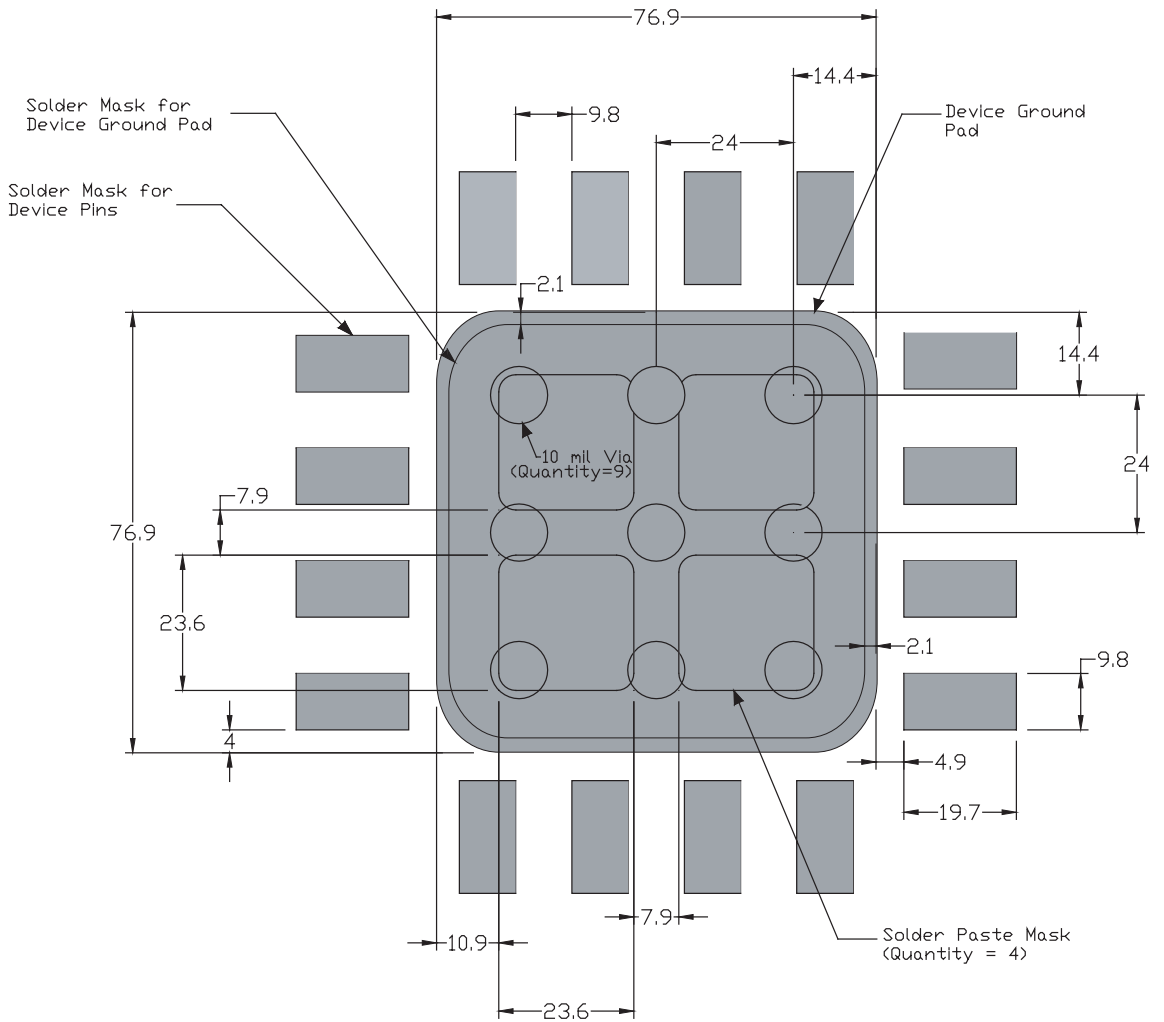

Figure 32: Recommended PCB Layout (all units are in mils)

ORDERING INFORMATION

ORDER NUMBER	TEMPERATURE RANGE	PACKAGE DESCRIPTION	COMPONENT PACKAGING
AWL6254RS35P8	-40 °C to +85 °C	RoHS-compliant 16 Pin 3 mm x 3 mm x 0.55 mm Surface Mount IC	2,500 piece Tape and Reel
EVA6254RS35	-40 °C to +85 °C	RoHS-compliant 16 Pin 3 mm x 3 mm x 0.55 mm Surface Mount IC	1 piece Evaluation Board

**ANADIGICS, Inc.**

141 Mount Bethel Road
Warren, New Jersey 07059, U.S.A.

Tel: +1 (908) 668-5000

Fax: +1 (908) 668-5132

URL: <http://www.anadigics.com>

E-mail: Mktg@anadigics.com

IMPORTANT NOTICE

ANADIGICS, Inc. reserves the right to make changes to its products or to discontinue any product at any time without notice. The product specifications contained in Advanced Product Information sheets and Preliminary Data Sheets are subject to change prior to a product's formal introduction. Information in Data Sheets have been carefully checked and are assumed to be reliable; however, ANADIGICS assumes no responsibilities for inaccuracies. ANADIGICS strongly urges customers to verify that the information they are using is current before placing orders.

WARNING

ANADIGICS products are not intended for use in life support appliances, devices or systems. Use of an ANADIGICS product in any such application without written consent is prohibited.