

PHASE CONTROL THYRISTOR H507CHXX

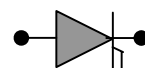

| Symbol | Characteristics | Conditions | T_J ($^{\circ}\text{C}$) | Value | Unit |
|--|---|---|---------------------------------|-----------|-----------------------------|
| BLOCKING PARAMETERS | | | | | |
| V_{RRM} | Repetitive peak reverse voltage | | 125 | 200-1600 | V |
| V_{DRM} | Repetitive peak off-stage voltage | | 125 | 200-1600 | V |
| I_{RRM} | Repetitive peak reverse current | $V = V_{RRM}$ | 125 | 50 | mA |
| I_{DRM} | Repetitive peak off-state current | $V = V_{RRM}$ | 125 | 50 | mA |
| CONDUCTING PARAMETERS | | | | | |
| $I_{F(AV)}$ | Average on-state current | 180 sine, 50Hz, $T_C = 85^{\circ}\text{C}$ | | 507 | A |
| I_{RMS} | RMS on-state current | | | 800 | A |
| I_{TSM} | Surge on-state current | Sine wave, 10mS without reverse voltage | 125 | 8 | kA |
| I^2t | I^2t | | | 320 | kA^2S |
| V_T | Peak on-state voltage drop | On-state current = 1.6kA | 125 | 1.92 | V |
| V_0 | Threshold voltage | | 125 | 0.80 | V |
| R_0 | On-state slope resistance | | 125 | 0.60 | $\text{m}\Omega$ |
| TRIGGERING PARAMETERS | | | | | |
| I_{GT} | Gate trigger current | $V_D = 5V$ | 25 | 200 | mA |
| V_{GT} | Gate trigger voltage | | 25 | 2.00 | V |
| I_L | Latching Current | $V_D = 5V$ | 25 | 600 | mA |
| P_{G-PEAK} | Maximum Peak Gate Power | Pulse width 100 μSec | | 150 | W |
| di/dt | Repetitive rate of rise of current | | | 250 | $\text{A}/\mu\text{Sec}$ |
| V_{FGM} | Maximum forward gate voltage | | | 12 | V |
| I_{FGM} | Maximum forward gate current | | | 30 | A |
| THERMAL & MECHANICAL PARAMETERS | | | | | |
| $R_{TH(J-C)}$ | Thermal impedance, 180 conduction, Sine | Junction to case | | 0.053 | $^{\circ}\text{C}/\text{W}$ |
| $R_{TH(C-HK)}$ | Thermal impedance | Case to heatsink | | 0.015 | $^{\circ}\text{C}/\text{W}$ |
| T_J | Maximum Permissible junction temperature | | | 125 | $^{\circ}\text{C}$ |
| T_{STG} | Storage temperature range | | | -40 - 125 | $^{\circ}\text{C}$ |
| F | Mounting Torque | | | 8 | KN |
| W | Weight | | | 100 | gms |



PHASE CONTROL THYRISTOR H507CHXX

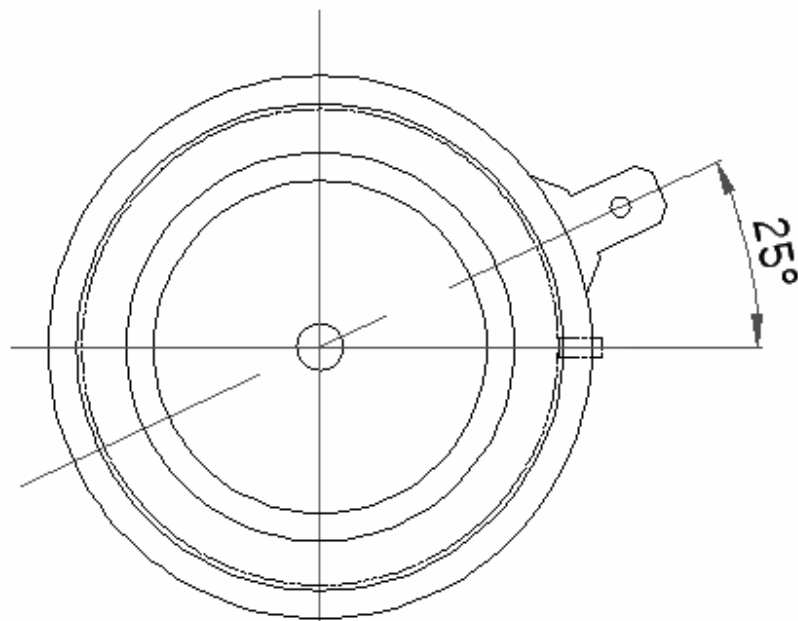
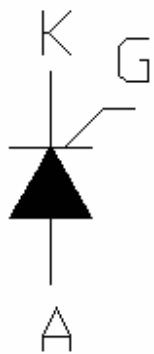
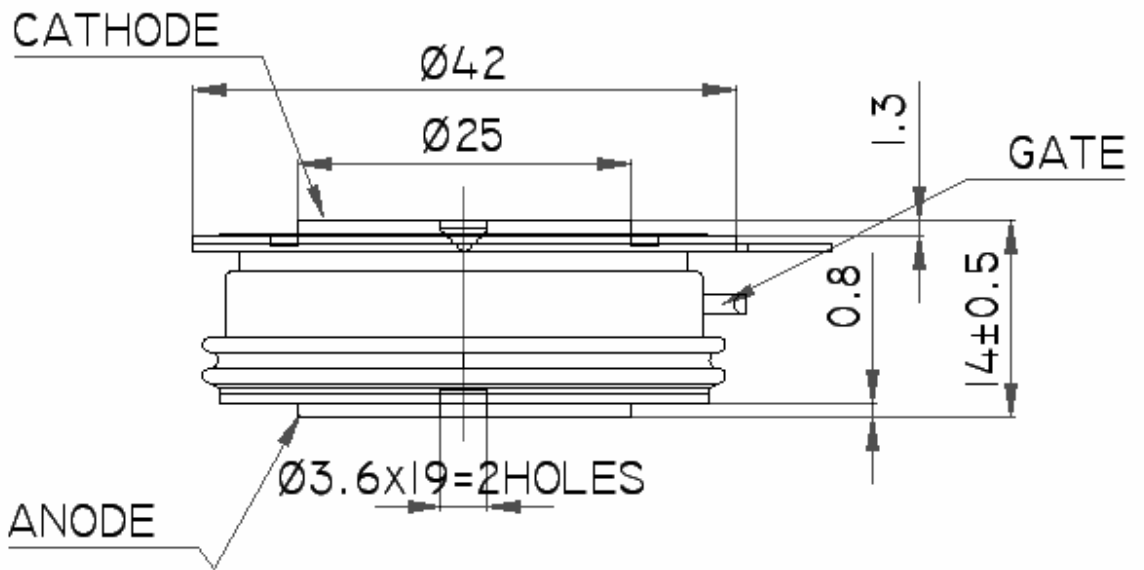
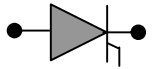

All dimensions in mm



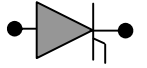

On State Power Loss

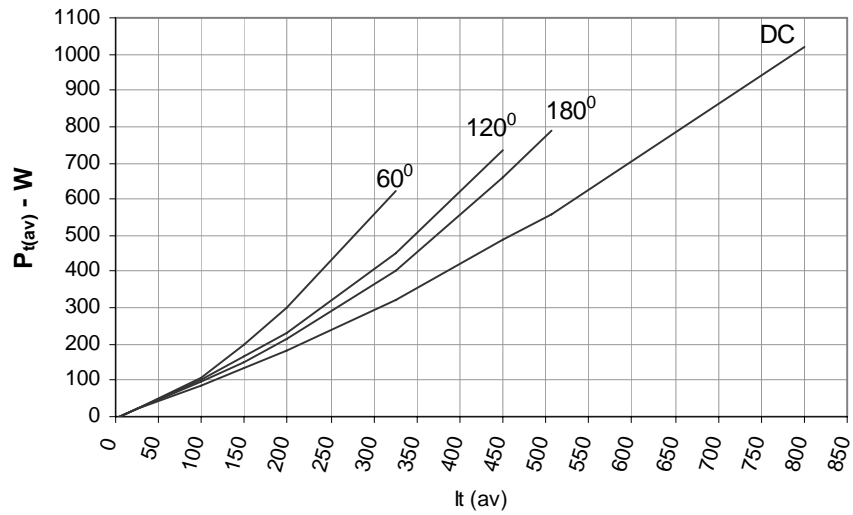

Maximum Permissible Case Temp

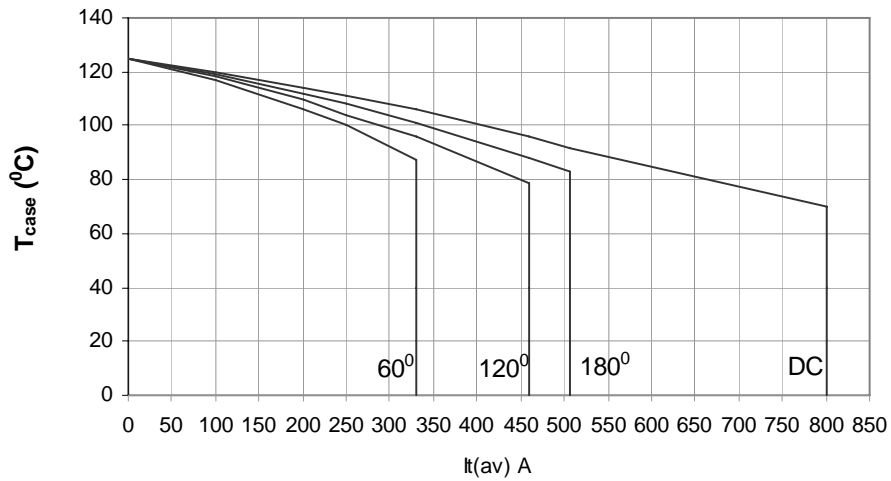

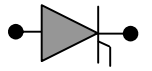

Max non repetitive Surge Current

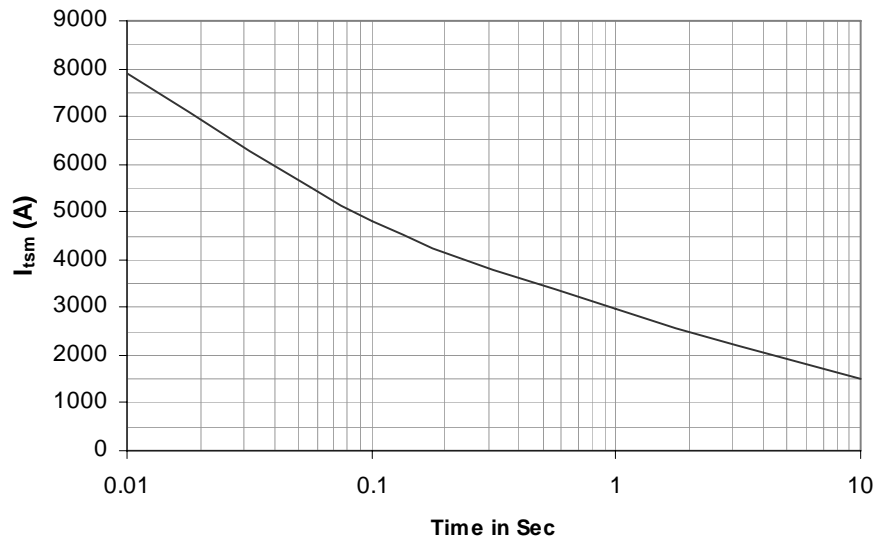

Transient Thermal Impedance Junction to Case

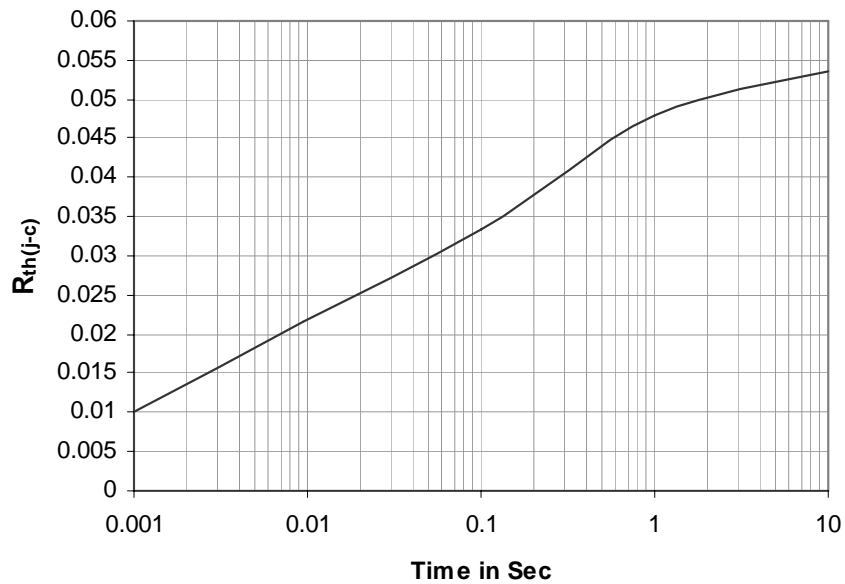

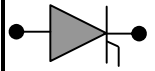

On State Characteristics

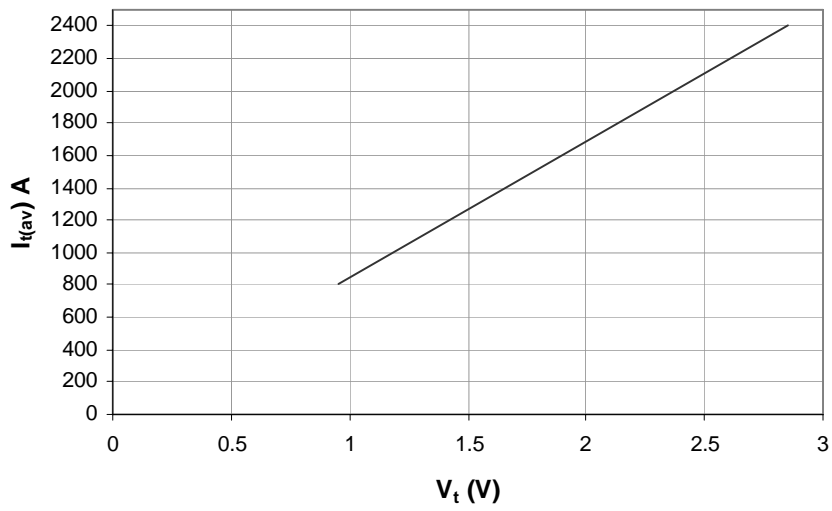

Gate Trigger Characteristics

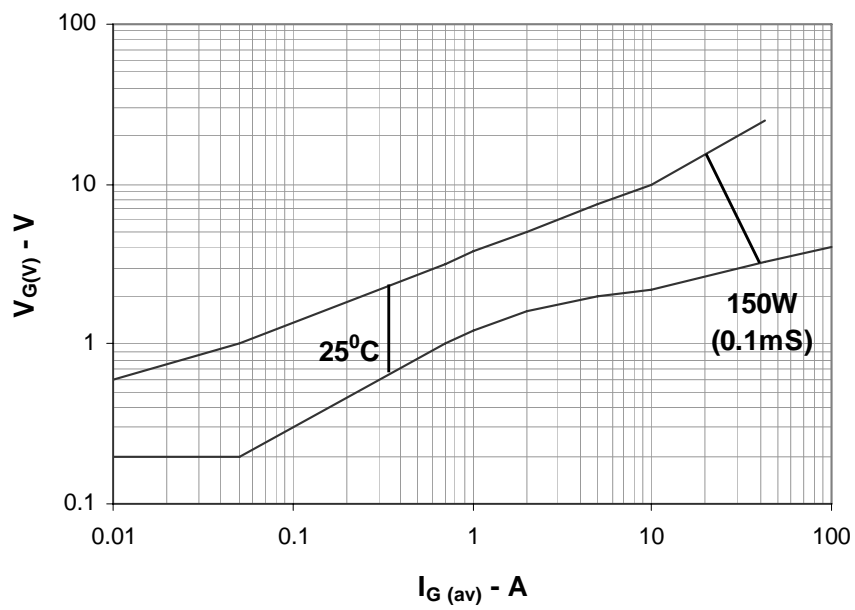

PHASE CONTROL THYRISTOR H507CHXX

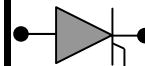

Ordering Information: -

| H | 507 | CH | XX |
|-----------------------|--------------------|-------------------|---|
| Hirect make Thyristor | $I_{F(AV)} = 507A$ | Capsule Thyristor | $V_{RRM} = XX * 100$ e.g. $12 * 100 = 1200V$ |

Hind Rectifiers Ltd reserves the right to change the specifications without notice.

This datasheet specifies technical information for semiconductor devices but promises no characteristics. No warranty or guarantee expressed or implied is made regarding delivery, performance or suitability.

Hind Rectifiers Ltd
Lake Road
Bhandup (West)
Mumbai – 400 078
Tel: - +91 22 2596 8027/28/29/31
Fax: - +91 22 2596 4114
E-mail: - marketing@hirect.com
Website: - www.hirect.com

June-2008



HIND RECTIFIERS LTD

6 of 6