

Features

- VFD display 12 hour clock function
- Directly drive VFD panels at 1/2 Duty cycle
- 4.194304MHz crystal oscillation
- Zero adjust function
- Integrated voltage regulator permits wide 4V to 18V operating voltage range
- Four levels of illumination control function
- 30-pin SSOP package

General Description

The HT16562 provides direct drive to VFD panels to implement a 12 hour clock function. Obtaining its time base from a 4.194304MHz crystal oscillation source and in having a wide operating voltage due to its internal voltage regulator, the device also contains a host of

other features. These include a choice of adjustment modes, including single push increment or 2Hz fast forward functions. Additional features are provided in the form of Blank control, Zero adjustment and four levels of illumination control.

Block Diagram

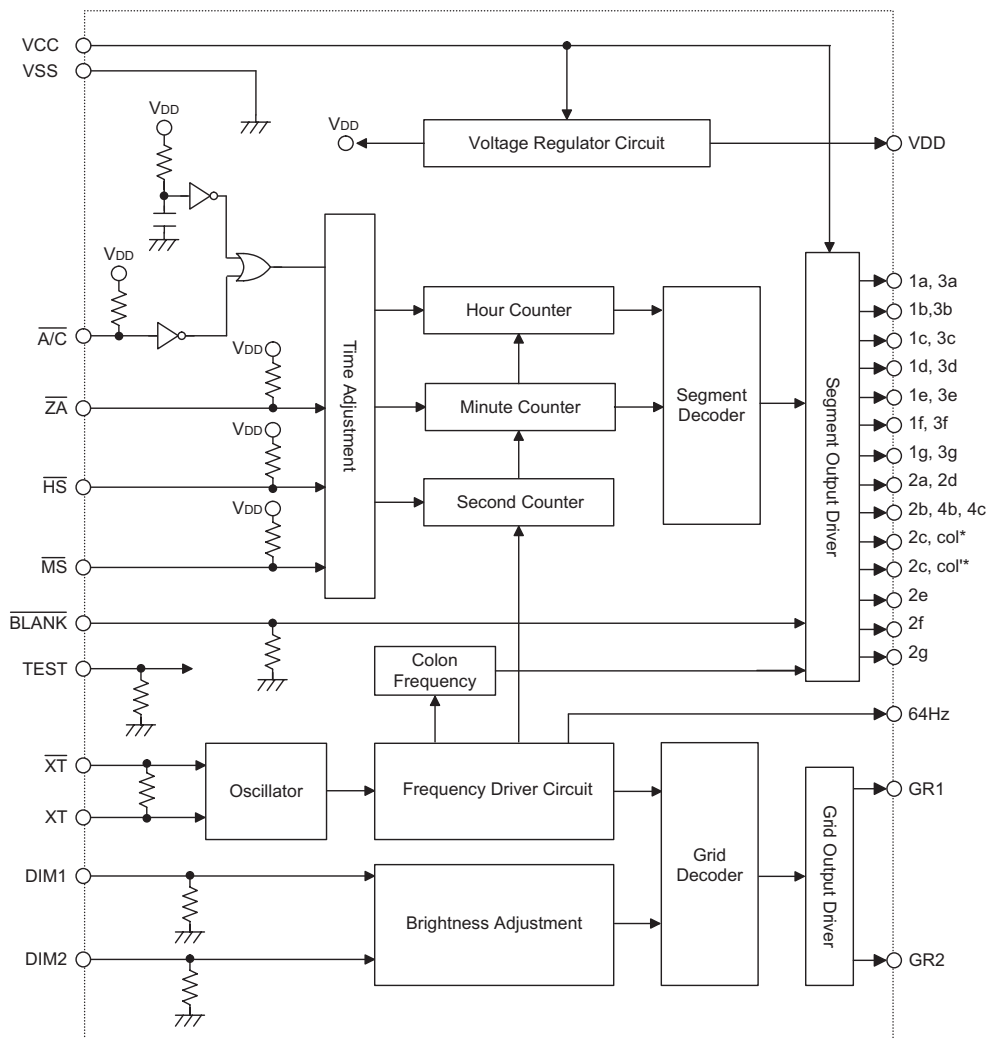

Note: "*" col indicates a blink colon and col' indicates a continuous light colon.

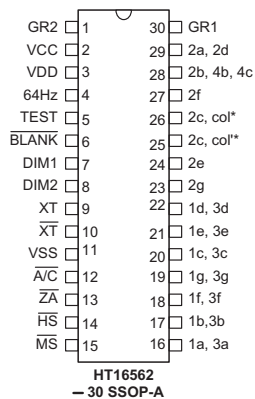
Pin Assignment

Note: "*" col indicates a blink colon and col' indicates a continuous light colon.

Pin Description

Pin Name	I/O	Description
VCC	—	High voltage power supply pin.
VDD	O	Built-in regulator voltage output pin for the device internal circuits.
VSS	—	Ground pin.
DIM1	I	Illumination level control pins.
DIM2	I	Internally connected to pull-down resistors.
$\overline{A/C}$	I	When the $\overline{A/C}$ pin is low, the internal circuits are reset. The reset pulse width should be more than 2 μ s. Internally connected to a pull-high resistor.
$\overline{Z}A$	I	Zero Adjustment pin. Internally connected to a pull-high resistor.
$\overline{H}S$	I	Hour Adjustment pin. Internally connected to a pull-high resistor.
$\overline{M}S$	I	Minute Adjustment pin. Internally connected to a pull-high resistor.
$\overline{B}LANK$	I	When low the Blank input pin will extinguish the display. Internally connected to a pull-down resistor.
$\overline{X}T$	O	Crystal oscillator pin
XT	I	
TEST	I	IC test pin - should be left open or kept at a low level
64Hz	O	64Hz signal output pin for oscillation frequency adjustment
GR1	O	Grid output pins for 1/2 duty VFD
GR2	O	
1a,3a ~ 2b,4b,4c	O	Segment output pins for 1/2 duty VFD

Approximate Internal Connections

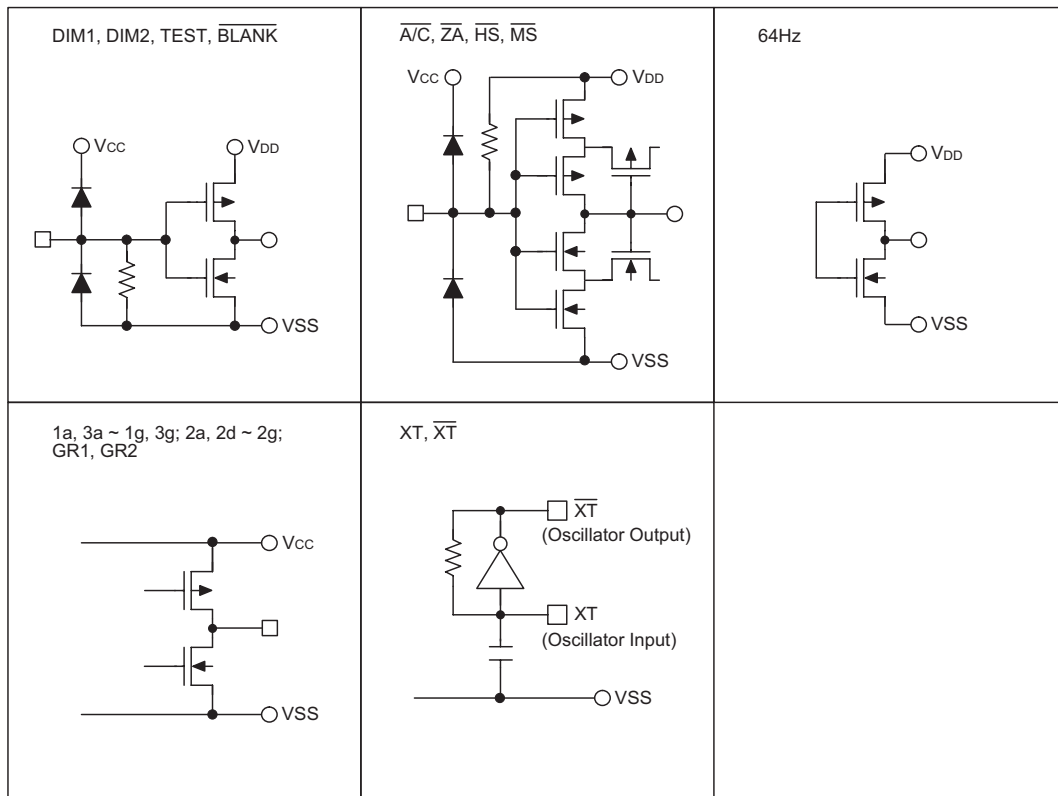

Absolute Maximum Ratings

Logic Supply Voltage $V_{SS}-0.3V$ to $V_{SS}+6.5V$	Driver Supply Voltage $V_{SS}-0.3V$ to $V_{SS}+20V$
High Input Voltage $V_{SS}-0.3V$ to $V_{CC}+0.3V$	High Output Voltage $V_{SS}-0.3V$ to $V_{CC}+0.3V$
Logic Input Voltage $V_{SS}-0.3V$ to $V_{DD}+0.3V$	Logic Output Voltage $V_{SS}-0.3V$ to $V_{DD}+0.3V$
Driver Output Voltage $V_{SS}-0.3V$ to V_{CC}	Driver Output Current (Segment Driver) -10mA to +2mA
Driver Output Current (Grid Driver)-7mA to +20mA	Storage Temperature-55°C to +150°C
Operating Temperature-40°C to +85°C	

Note: These are stress ratings only. Stresses exceeding the range specified under "Absolute Maximum Ratings" may cause substantial damage to the device. Functional operation of this device at other conditions beyond those listed in the specification is not implied and prolonged exposure to extreme conditions may affect device reliability.

Recommended Operating Conditions

Symbol	Parameter	Min.	Typ.	Max.	Unit
V_{CC}	Power Supply Voltage	4	—	18	V
f_{osc}	Oscillation Frequency	—	4.194304	—	MHz
t_{OP}	Operating Temperature	-40	—	85	°C

D.C. Characteristics
 $V_{CC}=12V, V_{SS}=0V, T_a=-40^{\circ}C-85^{\circ}C$

Symbol	Parameter	Test Conditions		Min.	Typ.	Max.	Unit
		V _{DD}	Conditions				
V _{IH}	High Input Voltage	—	V _{CC} = 8V to 18V	3.6	—	—	V
V _{IL}	Low Input Voltage	—	V _{CC} = 8V to 18V	—	—	1	V
I _{IL1}	Low-level Input Current	18V	Dim1, Dim2, \overline{BLANK} , Test pins low	-1	—	—	μA
I _{IH1}	Hi-level Input Current	18V	Dim1, Dim2, \overline{BLANK} , Test pins high	50	—	200	μA
I _{IL2}	Low-level Input Current	18V	XT pin low	-3	—	3	μA
I _{IH2}	Hi-level Input Current	18V	XT pin high	-3	—	3	μA
I _{IL3}	Low-level Input Current	18V	$\overline{A/C}, \overline{Z\overline{A}}, \overline{HS}, \overline{MS}$ pins low	-200	—	-50	μA
I _{OL}	Low-level Output current	12V	V _{OL} = 0.5V for 64Hz pin	100	—	—	μA
I _{OH}	Hi-level Output current	12V	V _{OL} = 4.0V for 64Hz pin	—	—	-100	μA
I _{SOL}	Driver Output Low Voltage (All Segment outputs)	12V	V _{SOL} = 0.7V	15	—	—	μA
I _{SOH}	Driver Output High Voltage (All Segment outputs)	12V	V _{SOL} = 11.3V	—	—	-1.0	mA
I _{GOL}	Driver Output Low Voltage (Grid1,Grid2)	12V	V _{SOL} = 0.7V	15	—	—	μA
I _{GOH}	Driver Output High Voltage (Grid1,Grid2)	12V	V _{SOL} = 11.3V	—	—	-15	mA
I _{CC}	Dynamic Current Consumption	12V	f _{OSC} = 4.194304MHz, Oscillator external capacitors = 22pF	—	—	1.0	mA

Functional Description

VFD Display Driving

The display can directly drive VFD signals dynamically and does so at a 1/2 duty cycle rate. The clock will be displayed in a 12-hour format with the hours ranging from 1 to 12 and minutes from 00 to 59. If the most significant numeral is zero then the display will be extinguished.

- Grid and segment connections

A single 7-segment display is shown below showing the illumination pattern for each numeral.



As the device is designed for clock applications, four 7-segment displays are required to display the correct time output. The connections for the grids and segments are shown below, however it should be noted that the fourth segment only requires two of its segments to be driven. Additionally it should be noted that the colon can also be illuminated.

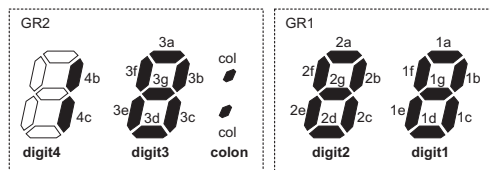

Other Pin Functions

The external reset pin $\overline{A/C}$ is used to reset the internal circuits of the device. When this pin is pulled low the device will be reset, when the pin is allowed to go high, via its internal pull-high resistor, then the display will indicate a "1:00" output.

The \overline{BLANK} pin, if pulled low will extinguish the display. Note that during the time when the \overline{BLANK} pin is low, the \overline{HS} , \overline{MS} and \overline{ZA} pins will be automatically disabled by the device and have no function.

The 64Hz pin allows monitoring of the system frequency to allow frequency adjustments to be executed. As the name suggests, this output pin will continuously output a frequency of 64Hz.

The TEST pin is used during manufacturing for device testing purposes and should not be connected to any external circuitry.

Two illumination level set pins, DIM1 and DIM2, are provided to give control over the display brightness level, as shown in the following table.

Switch Pin Name		Operating mode
Dim1	Dim2	
L	L	f=256Hz, 1/2 duty (50% display)
H	L	f=256Hz, 1/4 duty (25% display)
L	H	f=256Hz, 1/8 duty (12.5% display)
H	H	f=256Hz, 1/16 duty (6.25% display)

Device Functions

- Reset

Although the device is provided with an external reset pin $\overline{A/C}$, the device will in fact reset itself when power is applied, eliminating the need for external reset components. The usual provision of an external capacitor is not required as an internal reset capacitor is integrated within the device.
- Internal regulator

An internal regulator function is also integrated within the device providing a stable voltage power supply source for the internal circuits. This allows the device to operate with a wide external power supply ranging from 4V to 18V.
- Chatter removal

The device contains circuits which are connected to input pins \overline{HS} , \overline{MS} and \overline{ZA} to remove chatter of less than 31.25ms.
- Oscillator

The basic time base frequency for this device is determined by an external 4.194304MHz crystal. When an external crystal along with two small external capacitors are connected to the two oscillator XT pins, the internal oscillator circuit will ensure generation of the correct time base signals. The oscillation frequency, although determined by the external crystal frequency, will also be influenced by the external capacitors, the crystal inherent capacitance and the residual capacitance of the external PCB tracks. To ensure accurate frequency generation, the crystal specification should be carefully consulted and the external capacitors and crystal should be placed as close to the device as possible.

Time Adjustment Operation

- Hour/minute adjustment
Both the minutes and hour displays can be adjusted separately or both together in a fast forward format. The hour set pin, HS, and the minutes set pin, MS, are used to make these adjustments. Both of these pins are connected to internal pull-high resistors. Each time one of these lines is pulled low, the respective hour or minute value will increment by one, also if the line is continuously held low then the respective value will increment automatically at a rate of 2Hz. Both values will increment together if both lines are pulled low simultaneously. Note that no carry functions will be implemented when either the hour or minute value overflows.
- Zero adjustment
A zero adjust function is also included within the device and is controlled by the ZA pin. This pin is connected to an internal pull-high resistor. Pulling this line low will reset both the internal minutes and seconds value, however the way in which the display is reset depends upon the present value of the display. If the

minute value is presently less than 30 the only the second and minute values will be reset to zero and the hour value remain unchanged. However if the minute value is presently at a value of 30 or higher then when the zero adjustment function is executed, a carry will be implemented and the hour value will be incremented by one. The following table illustrates a few examples of this operation.

Zero Adjust Examples					
Present Time			After Zero Adjust		
Hr.	Min.	Sec.	Hr.	Min.	Sec.
1	30	00	2	00	00
2	00	00	2	00	00
2	29	59	2	00	00
2	30	00	3	00	00
2	59	59	3	00	00
3	29	59	3	00	00

Application Circuits

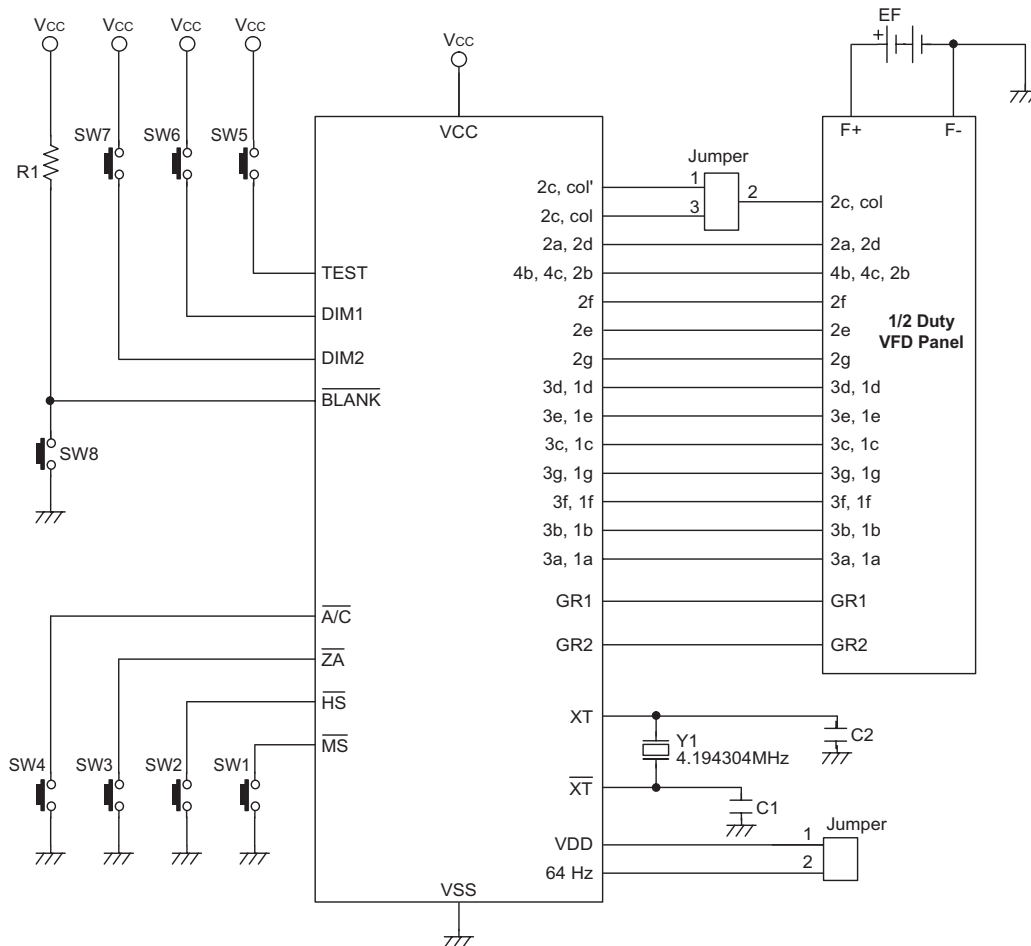

Note: Capacitor C9 and C10 can adjust the accuracy of frequency

Package Information

30-pin SSOP (300mil) Outline Dimensions

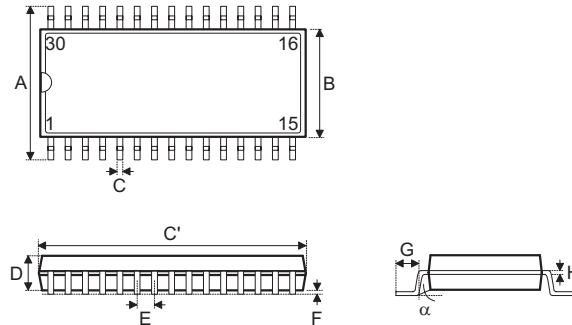

Symbol	Dimensions in mil		
	Min.	Nom.	Max.
A	291	—	323
B	196	—	220
C	9	—	15
C'	390	—	413
D	65	—	73
E	—	26	—
F	2	—	—
G	22	—	37
H	4	—	8
α	0°	—	8°

Holtek Semiconductor Inc. (Headquarters)

No.3, Creation Rd. II, Science Park, Hsinchu, Taiwan
Tel: 886-3-563-1999
Fax: 886-3-563-1189
<http://www.holtek.com.tw>

Holtek Semiconductor Inc. (Taipei Sales Office)

4F-2, No. 3-2, YuanQu St., Nankang Software Park, Taipei 115, Taiwan
Tel: 886-2-2655-7070
Fax: 886-2-2655-7373
Fax: 886-2-2655-7383 (International sales hotline)

Holtek Semiconductor Inc. (Shanghai Sales Office)

7th Floor, Building 2, No.889, Yi Shan Rd., Shanghai, China 200233
Tel: 86-21-6485-5560
Fax: 86-21-6485-0313
<http://www.holtek.com.cn>

Holtek Semiconductor Inc. (Shenzhen Sales Office)

5/F, Unit A, Productivity Building, Cross of Science M 3rd Road and Gaoxin M 2nd Road, Science Park, Nanshan District, Shenzhen, China 518057
Tel: 86-755-8616-9908, 86-755-8616-9308
Fax: 86-755-8616-9722

Holtek Semiconductor Inc. (Beijing Sales Office)

Suite 1721, Jinyu Tower, A129 West Xuan Wu Men Street, Xicheng District, Beijing, China 100031
Tel: 86-10-6641-0030, 86-10-6641-7751, 86-10-6641-7752
Fax: 86-10-6641-0125

Holtek Semiconductor Inc. (Chengdu Sales Office)

709, Building 3, Champagne Plaza, No.97 Dongda Street, Chengdu, Sichuan, China 610016
Tel: 86-28-6653-6590
Fax: 86-28-6653-6591

Holtek Semiconductor (USA), Inc. (North America Sales Office)

46729 Fremont Blvd., Fremont, CA 94538
Tel: 1-510-252-9880
Fax: 1-510-252-9885
<http://www.holtek.com>

Copyright © 2007 by HOLTEK SEMICONDUCTOR INC.

The information appearing in this Data Sheet is believed to be accurate at the time of publication. However, Holtek assumes no responsibility arising from the use of the specifications described. The applications mentioned herein are used solely for the purpose of illustration and Holtek makes no warranty or representation that such applications will be suitable without further modification, nor recommends the use of its products for application that may present a risk to human life due to malfunction or otherwise. Holtek's products are not authorized for use as critical components in life support devices or systems. Holtek reserves the right to alter its products without prior notification. For the most up-to-date information, please visit our web site at <http://www.holtek.com.tw>.