

Agilent HDSP-511x/513x 14.22 mm (0.56 inch) General Purpose Seven-Segment Display Data Sheet

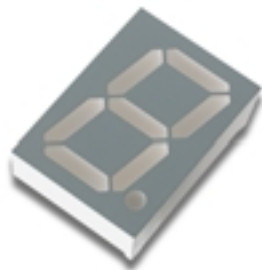
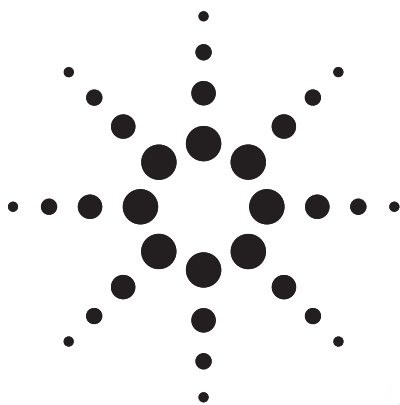

Description

This 14.22 mm (0.56 inch) LED seven-segment display uses industry standard size package and pinout. The device is available in either common anode or common cathode.

The choice of colors includes High Efficiency Red (HER), Green, AlGaAs Red, and Yellow. The gray face displays are suitable for indoor use.

Features

- **Industry standard size**
- **Industry standard pinout**
14.22 mm (0.56 inch)
DIP lead on 2.54 mm
- **Choice of colors**
High Efficiency Red (HER), Green, AlGaAs Red, and Yellow
- **Excellent appearance**
Evenly lighted segments gray package gives optimum contrast $\pm 50^\circ$ viewing angle
- **Design flexibility**
Common anode or common cathode
Single digit
Left and right hand decimal point
- **Categorized for luminous intensity**
Green and yellow categorized for color

Applications

- **Suitable for indoor use**
- **Not recommended for industrial application, i.e., operating temperature requirements exceeding $+85^\circ\text{C}$ or below $-25^\circ\text{C}^{(1)}$**
- **Extreme temperature cycling not recommended**

Notes:

1. For additional details, please contact your local Agilent sales office or an authorized distributor.

Devices

HER	Green	AlGaAs Red	Yellow	Description
HDSP-511E	HDSP-511G	HDSP-511A	HDSP-511Y	Common Anode, Right Hand Decimal
HDSP-513E	HDSP-513G	HDSP-513A	HDSP-513Y	Common Cathode, Right Hand Decimal



Part Numbering System

5082 -X X X X-X X X X X

HDSP-X X X X-X X X X X

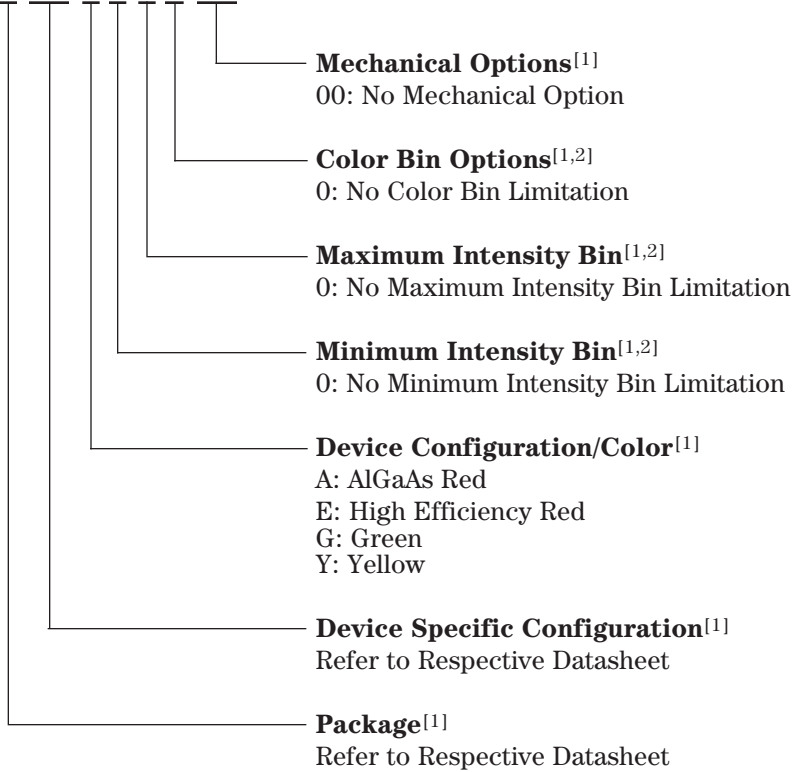

Notes:

1. For codes not listed in the figure above, please refer to the respective datasheet or contact your nearest Agilent representative for details.
2. Bin options refer to shippable bins for a part number. Color and Intensity Bins are typically restricted to 1 bin per tube (exceptions may apply). Please refer to respective datasheet for specific bin limit information.

Package Dimensions

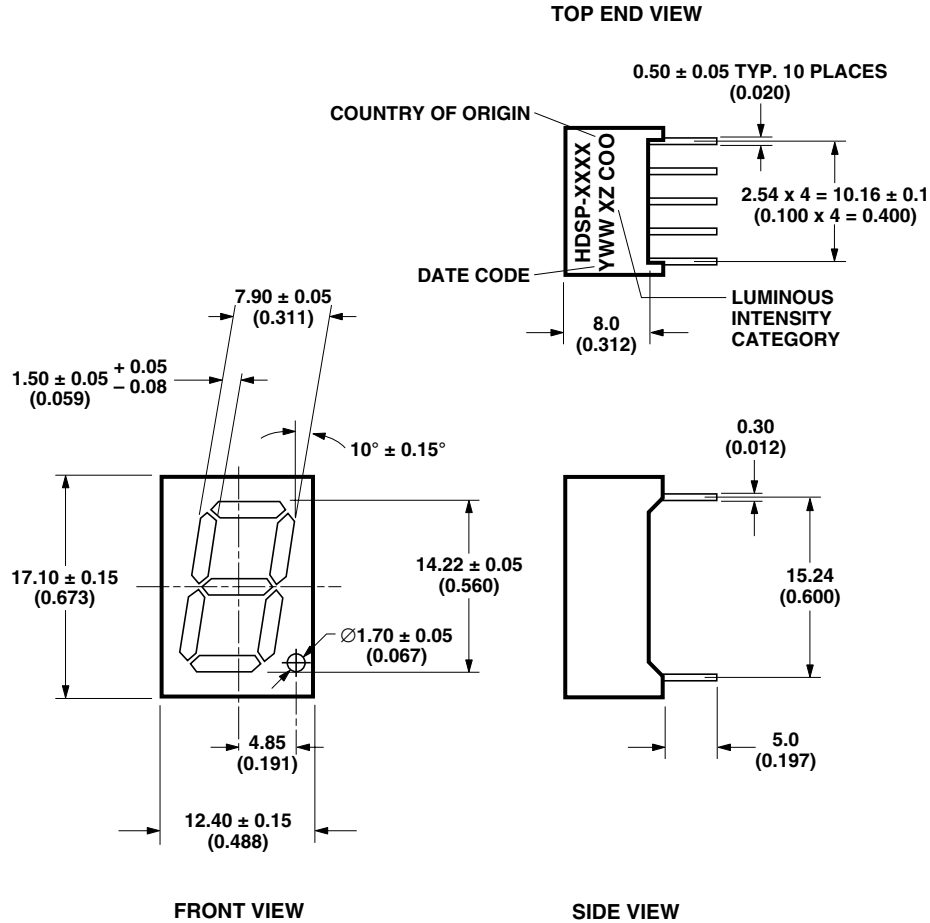

ALL DIMENSIONS ARE IN MILLIMETERS (INCHES).

Internal Circuit Diagram

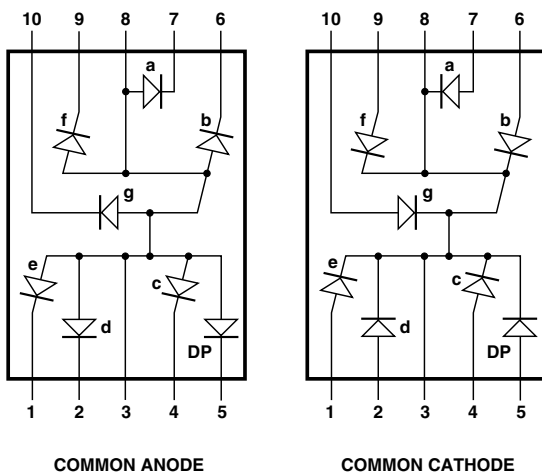

HDSP-511E/511G/511Y/511A		HDSP-513E/513G/513Y/513A	
COMMON ANODE		COMMON CATHODE	
PIN	FUNCTION	PIN	FUNCTION
1	CATHODE e	1	ANODE e
2	CATHODE d	2	ANODE d
3	COMMON ANODE	3	COMMON CATHODE
4	CATHODE c	4	ANODE c
5	CATHODE DP	5	ANODE DP
6	CATHODE b	6	ANODE b
7	CATHODE a	7	ANODE a
8	COMMON ANODE	8	COMMON CATHODE
9	CATHODE f	9	ANODE f
10	CATHODE g	10	ANODE g

Absolute Maximum Ratings at T_A = 25°C

Description	HER HDSP-51xE	Green HDSP-51xG	AlGaAs Red HDSP-51xA	Yellow HDSP-51xY	Units
Power Dissipation Segment	60	65	30	52	mW
Forward Current Segment	25 ^[1]	25 ^[2]	15 ^[3]	20 ^[4]	mA
Peak Forward Current per Segment (1/10 Duty Factor at 10 KHz)	100	100	80	80	mA
Operating Temperature Range	-35 to +85	-35 to +85	-35 to +85	-35 to +85	°C
Storage Temperature Range	-35 to +85	-35 to +85	-35 to +85	-35 to +85	°C
Reverse Voltage per Segment or DP	5	5	5	5	V
Wavesoldering Temperature for 3 seconds (at 2 mm Distance from the body)	250	250	250	250	°C

Notes:

1. Derate above 25°C at 0.33 mA/°C.
2. Derate above 25°C at 0.33 mA/°C.
3. Derate above 25°C at 0.2 mA/°C.
4. Derate above 25°C at 0.27 mA/°C.

Electrical/Optical Characteristics at T_A = 25°C

High Efficiency Red (HER)

Device HDSP-	Parameter	Symbol	Min.	Typ.	Max.	Units	Test Conditions
511E	Luminous Intensity/Segment	I _V		1.73		mcd	I _F = 5 mA
513E			2.001	4.100		mcd	I _F = 10 mA
	Forward Voltage	V _F		2.05	2.40	V	I _F = 20 mA
	Peak Wavelength	λ _{PEAK}		635		nm	
	Dominant Wavelength	λ _d		620		nm	
	Reverse Voltage	VR	5			V	I _R = 100 μA

Green

Device HDSP-	Parameter	Symbol	Min.	Typ.	Max.	Units	Test Conditions
511G	Luminous Intensity/Segment	I _V	2.001	4.100		mcd	I _F = 10 mA
513G	Forward Voltage	V _F		2.06		V	I _F = 10 mA
			1.80	2.25	2.60	V	I _F = 20 mA
	Peak Wavelength	λ _{PEAK}		568		nm	
	Dominant Wavelength	λ _d		573		nm	
	Reverse Voltage	VR	5			V	I _R = 100 μA

AlGaAs Red

Device HDSP-	Parameter	Symbol	Min.	Typ.	Max.	Units	Test Conditions
511A	Luminous Intensity/Segment	I_V		4.93		mcd	$I_F = 5 \text{ mA}$
			3.201	6.500		mcd	$I_F = 10 \text{ mA}$
513A	Forward Voltage	V_F		1.85	2.00	V	$I_F = 20 \text{ mA}$
	Peak Wavelength	λ_{PEAK}		660		nm	
	Dominant Wavelength	λ_d		643		nm	
	Reverse Voltage	VR	5			V	$I_R = 100 \mu\text{A}$

Yellow

Device HDSP-	Parameter	Symbol	Min.	Typ.	Max.	Units	Test Conditions
511Y	Luminous Intensity/Segment	I_V		1.03		mcd	$I_F = 5 \text{ mA}$
			1.251	2.600		mcd	$I_F = 10 \text{ mA}$
513Y	Forward Voltage	V_F		2.15	2.60	V	$I_F = 20 \text{ mA}$
	Peak Wavelength	λ_{PEAK}		595		nm	
	Dominant Wavelength	λ_d		590		nm	
	Reverse Voltage	VR	5			V	$I_R = 100 \mu\text{A}$

Intensity Bin Limits (mcd at 10 mA)

Bin Name	HER/Green		Yellow		AlGaAs Red	
	Min. ^[1]	Max. ^[1]	Min. ^[1]	Max. ^[1]	Min. ^[1]	Max. ^[1]
H	NA	NA	1.251	2.000	NA	NA
I	2.001	3.200	2.001	3.200	NA	NA
J	3.201	5.050	3.201	5.050	3.201	5.050
K	5.051	8.000	NA	NA	5.051	8.000
L	NA	NA	NA	NA	8.001	12.650

Note:

1. Tolerance for each bin limit is $\pm 10\%$.

Color Bin Limits (nm at 10 mA)

Color	Bin	Dominant Wavelength (nm)	
		Min. ^[1]	Max. ^[1]
Green	3	569.1	571.0
	4	571.1	573.0
	5	573.1	575.0
Yellow	1	585.5	588.5
	2	588.5	591.5
	3	591.5	594.5

Note:

1. Tolerance for each bin limit is 1 nm.

High Efficiency Red (HER)

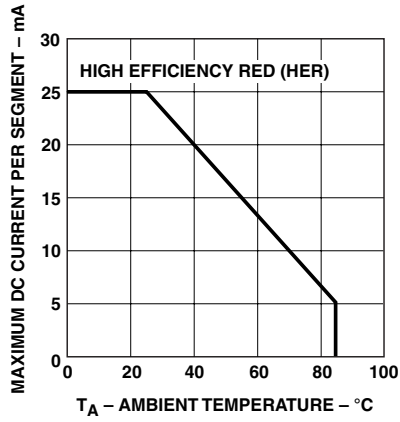

Figure 1. Maximum allowable average or DC current vs. ambient temperature.

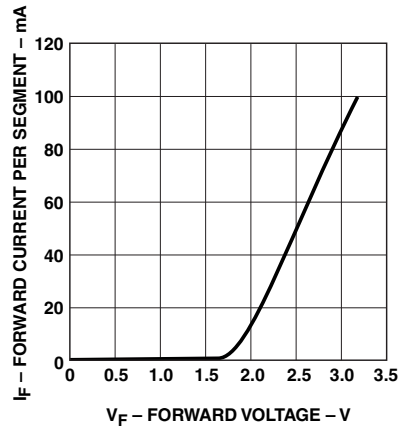

Figure 2. Forward current vs. forward voltage.

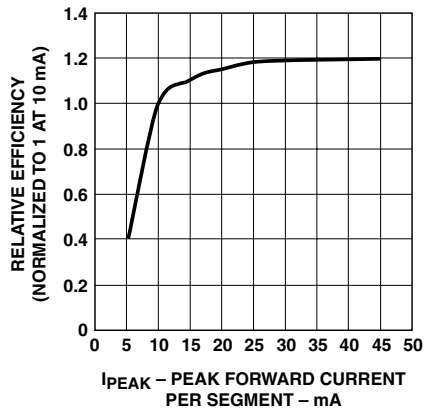

Figure 3. Relative luminous intensity vs. DC forward current.

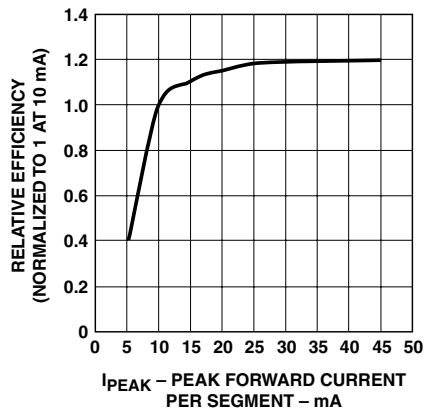

Figure 4. Relative efficiency (luminous intensity per unit current) vs. peak current.

Green

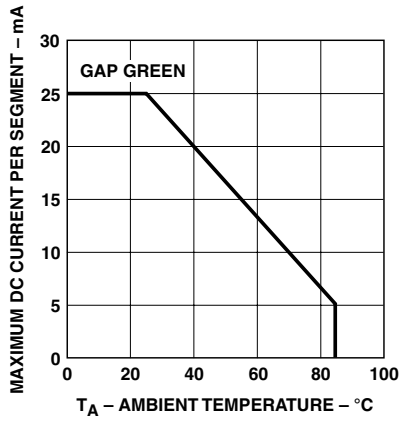

Figure 5. Maximum allowable average or DC current vs. ambient temperature.

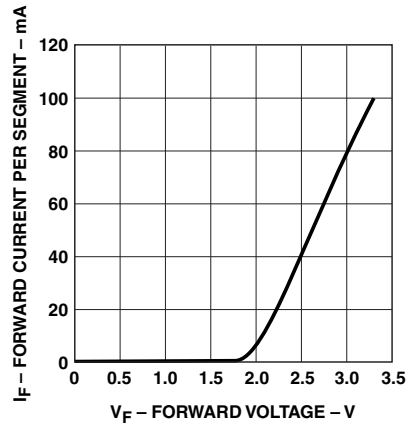

Figure 6. Forward current vs. forward voltage.

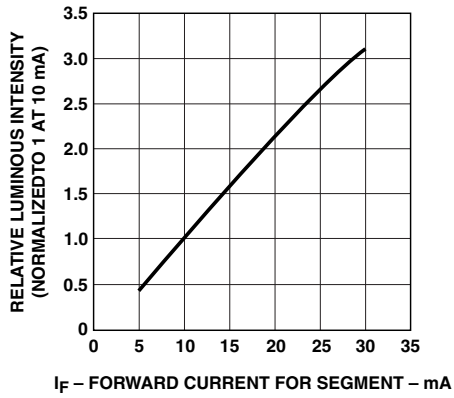

Figure 7. Relative luminous intensity vs. DC forward current.

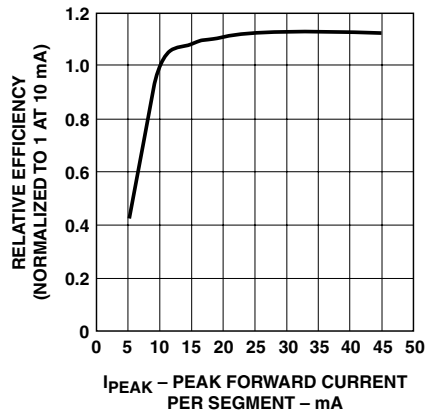

Figure 8. Relative efficiency (luminous intensity per unit current) vs. peak current.

AlGaAs Red

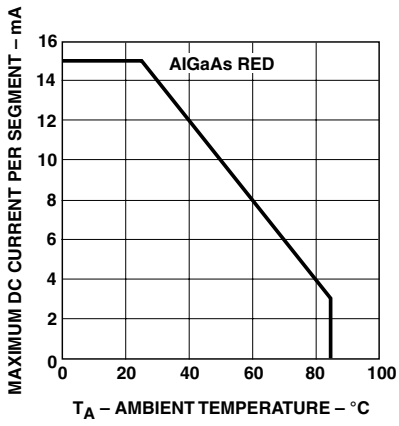

Figure 9. Maximum allowable average or DC current vs. ambient temperature.

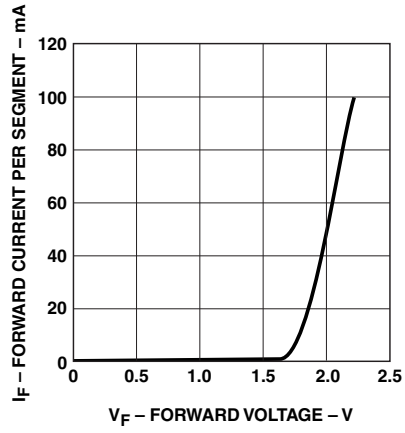

Figure 10. Forward current vs. forward voltage.

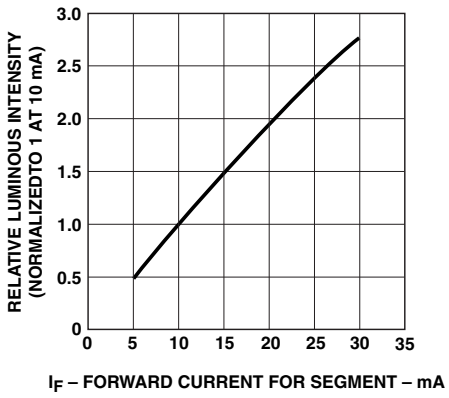

Figure 11. Relative luminous intensity vs. DC forward current.

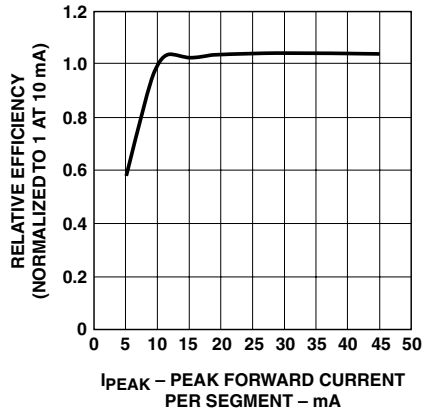

Figure 12. Relative efficiency (luminous intensity per unit current) vs. peak current.

Yellow

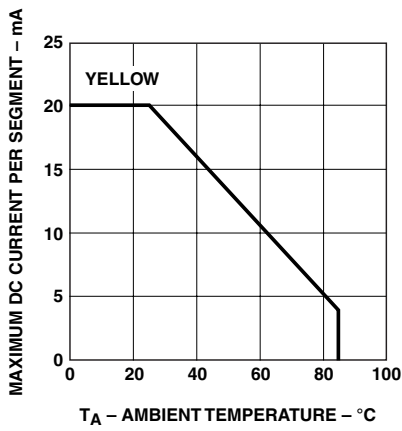

Figure 13. Maximum allowable average or DC current vs. ambient temperature.

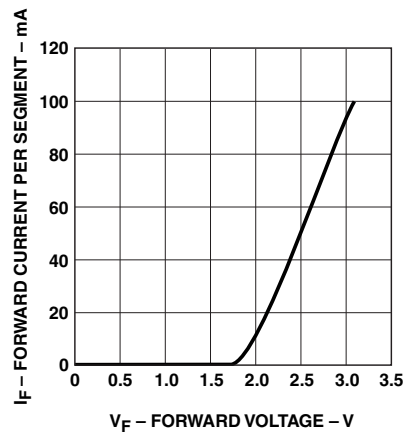

Figure 14. Forward current vs. forward voltage.

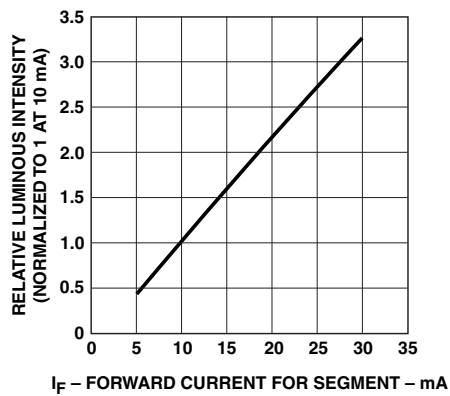

Figure 15. Relative luminous intensity vs. DC forward current.

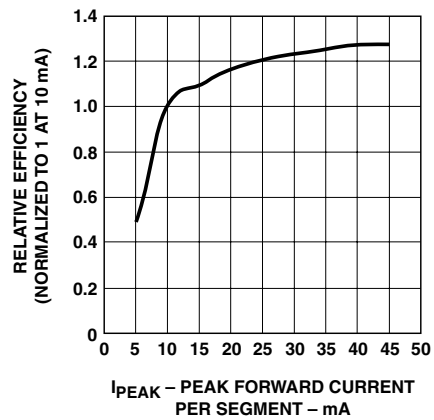

Figure 16. Relative efficiency (luminous intensity per unit current) vs. peak current.

www.agilent.com/semiconductors

For product information and a complete list of distributors, please go to our web site.

For technical assistance call:

Americas/Canada: +1 (800) 235-0312 or
(916) 788-6763

Europe: +49 (0) 6441 92460

China: 10800 650 0017

Hong Kong: (+65) 6756 2394

India, Australia, New Zealand: (+65) 6755 1939

Japan: (+81 3) 3335-8152(Domestic/
International), or 0120-61-1280(Domestic Only)

Korea: (+65) 6755 1989

Singapore, Malaysia, Vietnam, Thailand,
Philippines, Indonesia: (+65) 6755 2044

Taiwan: (+65) 6755 1843

Data subject to change.

Obsoletes 5980-2919EN

June 30, 2004

5988-2968EN



Agilent Technologies