

NARROW-PITCH CONNECTORS FOR BOARD-TO-BOARD CONNECTION

NARROW PITCH (0.5mm) CONNECTORS P5 SERIES — P5KF —

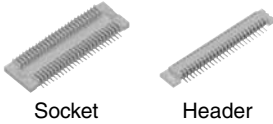

Compliance with RoHS Directive

FEATURES

- The connector is a two-piece structure and 0.5mm pitch.**
The product lineup consists of the mated height of 1.5mm, 2.0mm and 2.5mm.
- Strong resistance to adverse environments! Utilizes TOUGH CONTACT construction for high contact reliability.**
(See Page 6 for details of the structure)
- Simple locking structure**
Superior mating operation with click feel to indicate that mating is complete.

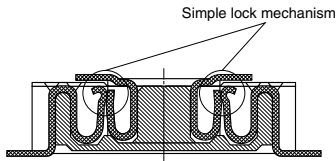

4. Mating length 0.55mm
While achieving a low profile of 1.5mm between PCBs, the effective mating length has been extended to ensure that there is some latitude in the mating.

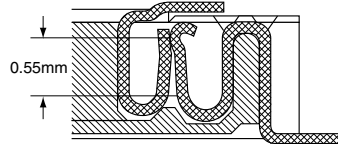

5. The lower connector bottom surface construction prevents contact and shorts between the PCB and metal terminals.
This enables freedom in pattern wiring, helping to make PCB's smaller.

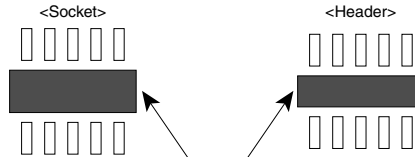

Connector bottom: Create any thru-hole and pattern wiring.

6. Automatic mounting inspection is facilitated by the gull-wing terminal shape which makes mounting verification easy.

7. Connectors for inspection available
Connectors for inspection are available that are ideal for modular unit inspection and inspection in device assembly processes.

APPLICATIONS

Compact portable devices "Cellular phones, DVC, Digital cameras, etc"

Ideal for Board-to-FPC connections

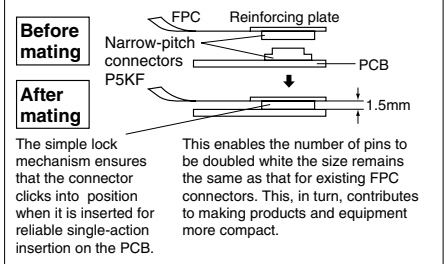

ORDERING INFORMATION

5F: Narrow Pitch Connector P5KF (0.5 mm pitch) Socket
6F: Narrow Pitch Connector P5KF (0.5 mm pitch) Header

Number of contacts (2 digits)

Mated height

<Socket>

3: For mated height 1.5 mm

5: For mated height 2.0 mm and 2.5 mm

<Header>

3: For mated height 1.5 mm and 2.0 mm

5: For mated height 2.5 mm

Functions

3: With positioning bosses

4: Without positioning bosses

Surface treatment (Contact portion / Terminal portion)

<Socket>

7: Ni plating on base, Au plating on surface/Ni plating on base, Au plating on surface (for Ni barrier available)

Contact portion

<Socket> Y: V notch type product (chamfered on both ends)

<Header> Y: V notch type product

Packing

G: 2,000 pieces embossed tape and plastic reel × 2

AXK 7 Y G

PRODUCT TYPES

Mated height	No. of contacts	Part No.		Packing	
		Socket	Header	Inner carton (1-reel)	Outer carton
		TOUGH CONTACT	TOUGH CONTACT		
1.5 mm	10	AXK5F10347YG	AXK6F10347YG	2,000 pieces	4,000 pieces
	12	AXK5F12347YG	AXK6F12347YG		
	14	AXK5F14347YG	AXK6F14347YG		
	16	AXK5F16347YG	AXK6F16347YG		
	18	AXK5F18347YG	AXK6F18347YG		
	20	AXK5F20347YG	AXK6F20347YG		
	22	AXK5F22347YG	AXK6F22347YG		
	24	AXK5F24347YG	AXK6F24347YG		
	26	AXK5F26347YG	AXK6F26347YG		
	30	AXK5F30347YG	AXK6F30347YG		
	32	AXK5F32347YG	AXK6F32347YG		
	34	AXK5F34347YG	AXK6F34347YG		
	40	AXK5F40347YG	AXK6F40347YG		
	50	AXK5F50347YG	AXK6F50347YG		
	60	AXK5F60347YG	AXK6F60347YG		
70	AXK5F70347YG	AXK6F70347YG			
80	AXK5F80347YG	AXK6F80347YG			
2.0 mm	10	AXK5F10547YG	AXK6F10347YG		
	12	AXK5F12547YG	AXK6F12347YG		
	14	AXK5F14547YG	AXK6F14347YG		
	16	AXK5F16547YG	AXK6F16347YG		
	18	AXK5F18547YG	AXK6F18347YG		
	20	AXK5F20547YG	AXK6F20347YG		
	22	AXK5F22547YG	AXK6F22347YG		
	24	AXK5F24547YG	AXK6F24347YG		
	26	AXK5F26547YG	AXK6F26347YG		
	30	AXK5F30547YG	AXK6F30347YG		
	34	AXK5F34547YG	AXK6F34347YG		
	40	AXK5F40547YG	AXK6F40347YG		
	50	AXK5F50547YG	AXK6F50347YG		
	60	AXK5F60547YG	AXK6F60347YG		
	70	AXK5F70547YG	AXK6F70347YG		
80	AXK5F80547YG	AXK6F80347YG			
100	AXK5F00547YG	AXK6F00347YG			
2.5 mm	10	AXK5F10547YG	AXK6F10547YG		
	12	AXK5F12547YG	AXK6F12547YG		
	14	AXK5F14547YG	AXK6F14547YG		
	16	AXK5F16547YG	AXK6F16547YG		
	20	AXK5F20547YG	AXK6F20547YG		
	22	AXK5F22547YG	AXK6F22547YG		
	24	AXK5F24547YG	AXK6F24547YG		
	30	AXK5F30547YG	AXK6F30547YG		
	34	AXK5F34547YG	AXK6F34547YG		
	36	AXK5F36547YG	AXK6F36547YG		
	40	AXK5F40547YG	AXK6F40547YG		
	44	AXK5F44547YG	AXK6F44547YG		
	50	AXK5F50547YG	AXK6F50547YG		
	60	AXK5F60547YG	AXK6F60547YG		
	70	AXK5F70547YG	AXK6F70547YG		
80	AXK5F80547YG	AXK6F80547YG			
100	AXK5F00547YG	AXK6F00547YG			

Notes: 1. Regarding ordering units, During production: Please make orders in 1-reel units.

Samples for mounting confirmation: Available in units of 50 pieces. Please consult us. (See "Regarding sample orders to confirm proper mounting" on page 19.)

Samples: Small lot orders are possible. Please consult us.

2. The standard type comes without positioning bosses. Connectors with positioning bosses are available for on-demand production. For this type of connector, 9th digit of the part no. changes from 4 to 3. e.g.

Mated height 1.5mm, 10 contacts for sockets: AXK5F10337YG

3. The 11th digit "Y" in the socket/header part number indicates the connector has a V notch. (For details, please consult one of our sales offices.)

4. Previous non-**TOUGH CONTACT** types and current **TOUGH CONTACT** types are compatible for mating.

AXK(5/6)F

SPECIFICATIONS

1. Characteristics

Item		Specifications	Conditions
Electrical characteristics	Rated current	0.5A/contact (Max. 10 A at total contacts)	
	Rated voltage	60V AC/DC	
	Breakdown voltage	150V AC for 1 minute	Detection current: 1mA
	Insulation resistance	Min. 1,000M Ω (initial)	Using 500V DC megger
	Contact resistance	Max. 90m Ω	Based on the contact resistance measurement method specified by JIS C 5402.
Mechanical characteristics	Composite insertion force	Max. 0.981N/contacts \times contacts (initial)	
	Composite removal force	Min. 0.0588N/contacts \times contacts	
	Contact holding force	Min. 0.981N/contact	Measuring the maximum force. As the contact is axially pull out.
Environmental characteristics	Ambient temperature	-55°C to +85°C	No freezing at low temperatures
	Soldering heat resistance	Max. peak temperature of 260°C (on the surface of the PC board around the connector terminals)	Infrared reflow soldering
		300°C within 5 seconds, 350°C within 3 seconds	Soldering iron
	Thermal shock resistance (header and socket mated)	5 cycles, insulation resistance min. 100M Ω , contact resistance max. 90m Ω	Sequence 1. -55 $\frac{0}{-3}$ °C, 30 minutes 2. ~, Max. 5 minutes 3. 85 $\frac{+3}{0}$ °C, 30 minutes 4. ~, Max. 5 minutes
	Humidity resistance (header and socket mated)	120 hours, insulation resistance min. 100M Ω , contact resistance max. 90m Ω	Bath temperature 40 \pm 2°C, humidity 90 to 95% R.H.
	Saltwater spray resistance (header and socket mated)	24 hours, insulation resistance min. 100M Ω , contact resistance max. 90m Ω	Bath temperature 35 \pm 2°C, saltwater concentration 5 \pm 1%
H ₂ S resistance (header and socket mated)	48 hours, contact resistance max. 90m Ω	Bath temperature 40 \pm 2°C, gas concentration 3 \pm 1 ppm, humidity 75 to 80% R.H.	
Lifetime characteristics	Insertion and removal life	50 times	Repeated insertion and removal speed of max. 200 times/hours
Unit weight		Mated height 1.5mm, 20 contacts; Socket: 0.06g Header: 0.04g	

2. Material and surface treatment

Part name	Material	Surface treatment
Molded portion	LCP resin (UL94V-0)	—
Contact/Post	Copper alloy	Contact portion: Ni plating on base, Au plating on surface Terminal portion: Ni plating on base, Au plating on surface (Except for thick of terminal) The section close to the soldering portion has a nickel barrier. (The nickel base is exposed.)

DIMENSIONS (Unit: mm) The CAD data of the products with a **CAD Data** mark can be downloaded from: <http://panasonic-electric-works.net/ac>

- Socket (Mated height: 1.5mm, 2.0mm, 2.5mm)

CAD Data



Dimension table (mm)

No. of contacts	A	B
10	5.50	2.00
12	6.00	2.50
14	6.50	3.00
16	7.00	3.50
18	7.50	4.00
20	8.00	4.50
22	8.50	5.00
24	9.00	5.50
26	9.50	6.00
30	10.50	7.00
32	11.00	7.50
34	11.50	8.00
36	12.00	8.50
40	13.00	9.50
44	14.00	10.50
50	15.50	12.00
60	18.00	14.50
70	20.50	17.00
80	23.00	19.50
100	28.00	24.50

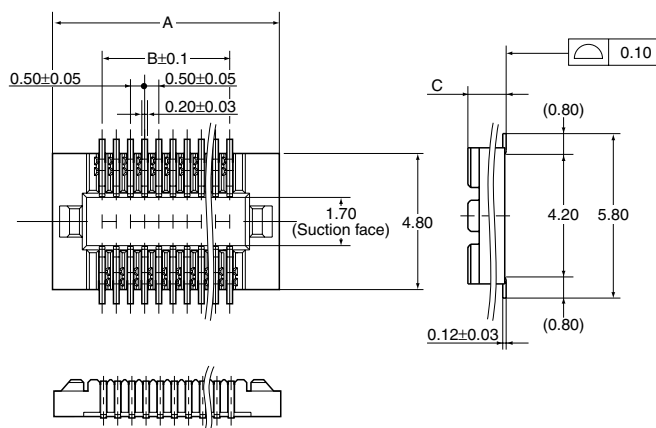

General tolerance: ±0.2

Mated height	C
1.5 mm	1.35
2.0 mm, 2.5 mm	1.85

- Header (Mated height: 1.5mm, 2.0mm, 2.5mm)

CAD Data



Dimension table (mm)

No. of contacts	A	B
10	5.50	2.00
12	6.00	2.50
14	6.50	3.00
16	7.00	3.50
18	7.50	4.00
20	8.00	4.50
22	8.50	5.00
24	9.00	5.50
26	9.50	6.00
30	10.50	7.00
32	11.00	7.50
34	11.50	8.00
36	12.00	8.50
40	13.00	9.50
44	14.00	10.50
50	15.50	12.00
60	18.00	14.50
70	20.50	17.00
80	23.00	19.50
100	28.00	24.50

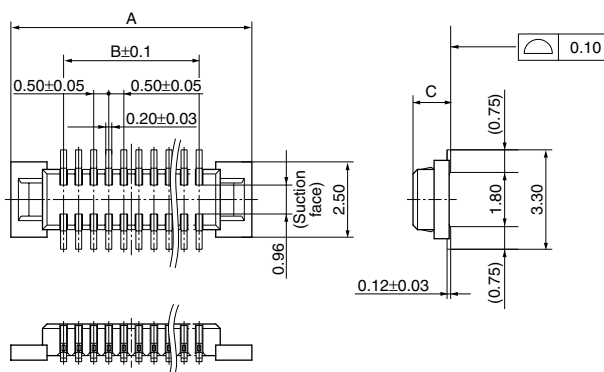

General tolerance: ±0.2

Mated height	C
1.5 mm, 2.0 mm	1.25
2.5 mm	1.75

- Socket and header are mated

Mated height: 1.5 mm



Mated height: 2.0 mm

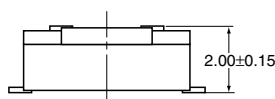

Mated height: 2.5 mm

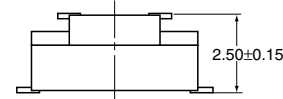

AXK(5/6)F

EMBOSSED TAPE DIMENSIONS (unit: mm, Common for respective contact type, socket and header)

• Tape dimensions (Conforming to JIS C 0806-1990.

• Plastic reel dimensions (Conforming to EIAJ ET-7200B)

However, some tapes have mounting hole pitches that do not comply with the standard.)

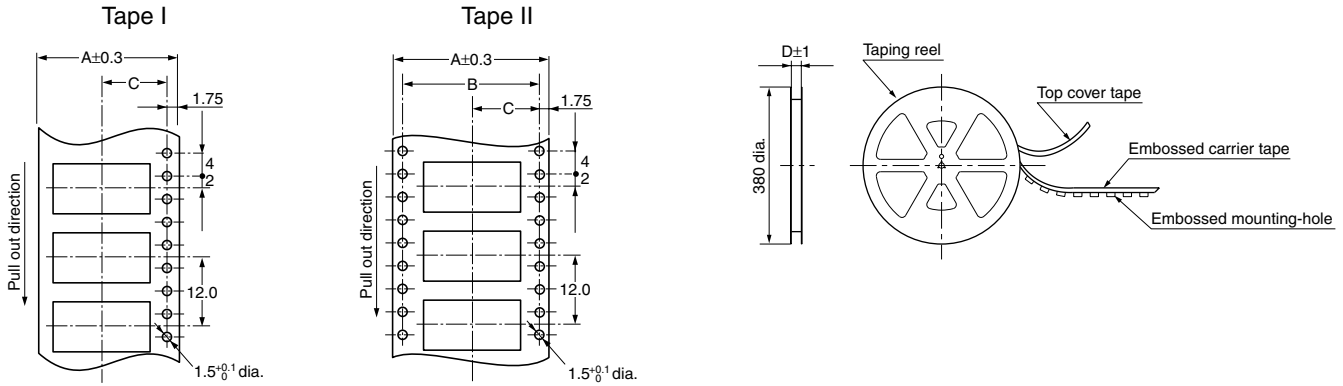

Dimension table (mm)

Suffix: G (1 reel, 2,000 pieces embossed tape: Plastic reel package)

Mated height	No. of contacts	Type of taping	A	B	C	D	Quantity per reel
Socket and header are common: 1.5mm, 2.0mm, 2.5mm	10 to 58	Tape I	24.0	—	11.5	25.4	2,000 pcs.
	60 to 70	Tape II	32.0	28.4	14.2	33.4	2,000 pcs.
	72 to 100	Tape II	44.0	40.4	20.2	45.4	2,000 pcs.

Connector orientation with respect to direction of progress of embossed tape

Direction of tape progress	Type	Common for P5KF	
	Socket	Header	
↓			

Note: There is no indication on this product regarding top-bottom or left-right orientation.

Panasonic

ideas for life

**CONNECTOR FOR INSPECTION
USAGE APPLICATIONS WITH
3,000 INSERTION AND
REMOVAL TIMES**

**NARROW PITCH CONNECTOR P5KF
(0.5 mm PITCHES) FOR INSPECTION USAGE**

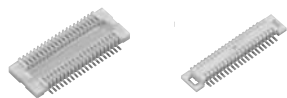

Socket

Header

Compliance with RoHS Directive

FEATURES

1. 3,000 insertion and removals (when as recommended)

From the 50 insertion and removals of standard type, up to 3,000 insertion and removals (with recommended insertion and removal) are possible for use in inspection.

Ideal for inspection of module units and inspection during the device assembly process

2. Same external dimensions and foot pattern as standard type.

Since shape is the same as standard type, inspection is possible without interfering with devices in the vicinity of standard connectors.

3. Improved mating

Insertion and removal have become easier due to a reduction in the mating retention force required by the simple locking structure and also in the amount of force needed for insertion and removal. (We cannot warrant anything regarding mating retention.)

TABLE OF PRODUCT TYPES

☆: Available for sale

Product name	P5KF for inspection
10	☆
12	☆
14	☆
16	☆
18	☆
20	☆
22	☆
24	☆
26	☆
30	☆
32	☆
34	☆
40	☆
50	☆
60	☆
70	☆
80	☆
100	☆

Notes:

1. You can use with each mated height in common.
2. Please inquire about numbers of contacts other than those given above.
3. Please inquire with us regarding delivery times.
4. Please keep the minimum unit for ordering no less than 50 pieces per lot.
5. Please inquire for further information.

PRODUCT TYPES

Specifications		Part No.	Specifications		Part No.
Socket	With positioning bosses	AXK5FE**36G	Header	With positioning bosses	AXK6FE**36G
	Without positioning bosses	AXK5FE**46G		Without positioning bosses	AXK6FE**46G

Note: When placing an order, substitute the "*" (asterisk) in the above part number with the number of contacts for the required connector.

NOTES

1. As shown below, excess force during insertion may result in damage to the connector or removal of the solder. Please be careful. Also, to prevent connector damage please confirm the correct position before mating connectors.

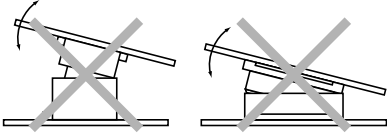

2. Keep the PC board warp no more than 0.03 mm in relation to the overall length of the connector.

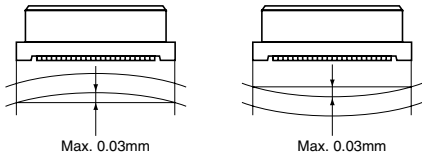

3. PC Boards and Recommended Metal Mask Patterns

Connectors are mounted with high density, with a pitch interval of 0.4 to 0.5 mm. It is therefore necessary to make sure that the right levels of solder are used, in order to reduce solder bridge and other issues. The figures to the right are recommended metal mask patterns. Please use them as a reference.

• Socket

Recommended PC board pattern (TOP VIEW)

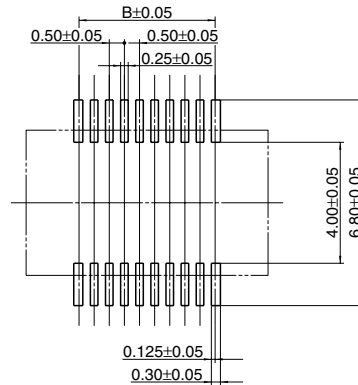

Recommended metal mask pattern
Metal mask thickness: Here, 150 μm
(Opening area ratio: 56%)

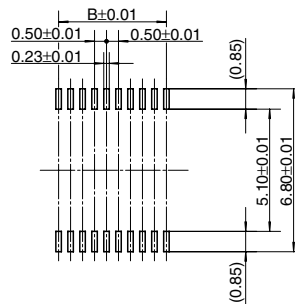

Recommended metal mask pattern
Metal mask thickness: Here, 120 μm
(Opening area ratio: 69%)

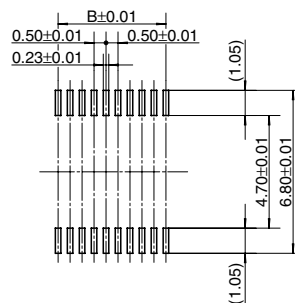

• Header

Recommended PC board pattern (TOP VIEW)

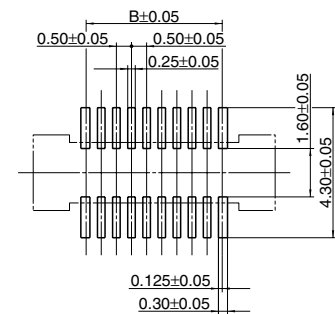

Recommended metal mask pattern
Metal mask thickness: Here, 150 μm
(Opening area ratio: 58%)

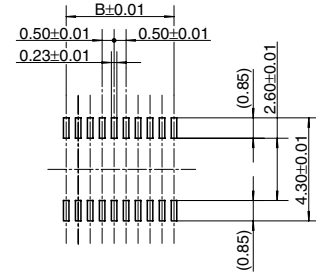

Recommended metal mask pattern
Metal mask thickness: Here, 120 μm
(Opening area ratio: 72%)

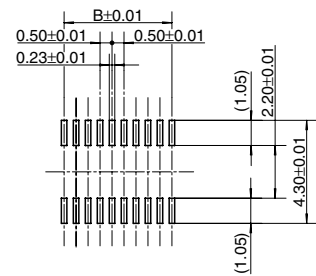

* See the dimension table on page 87 for more information on the B dimension of the socket and header.

For other details, please verify with the product specification sheets.

Mouser Electronics

Authorized Distributor

Click to View Pricing, Inventory, Delivery & Lifecycle Information:

Panasonic:

[AXK6F10347YG](#) [AXK5F40547YG](#) [AXK5F60347YG](#) [AXK5F00537YG](#) [AXK5F00547YG](#) [AXK5F10337YG](#)
[AXK5F10347YG](#) [AXK5F10537YG](#) [AXK5F10547YG](#) [AXK5F12337YG](#) [AXK5F12347YG](#) [AXK5F12537YG](#)
[AXK5F12547YG](#) [AXK5F14337YG](#) [AXK5F14347YG](#) [AXK5F14537YG](#) [AXK5F14547YG](#) [AXK5F16337YG](#)
[AXK5F16347YG](#) [AXK5F16537YG](#) [AXK5F16547YG](#) [AXK5F18337YG](#) [AXK5F18347YG](#) [AXK5F18537YG](#)
[AXK5F18547YG](#) [AXK5F20337YG](#) [AXK5F20347YG](#) [AXK5F20537YG](#) [AXK5F20547YG](#) [AXK5F22337YG](#)
[AXK5F22347YG](#) [AXK5F22537YG](#) [AXK5F22547YG](#) [AXK5F24337YG](#) [AXK5F24347YG](#) [AXK5F24537YG](#)
[AXK5F24547YG](#) [AXK5F26337YG](#) [AXK5F26347YG](#) [AXK5F26537YG](#) [AXK5F26547YG](#) [AXK5F30337YG](#)
[AXK5F30347YG](#) [AXK5F30537YG](#) [AXK5F30547YG](#) [AXK5F32337YG](#) [AXK5F32347YG](#) [AXK5F34337YG](#)
[AXK5F34347YG](#) [AXK5F34537YG](#) [AXK5F34547YG](#) [AXK5F36537YG](#) [AXK5F36547YG](#) [AXK5F40337YG](#)
[AXK5F40347YG](#) [AXK5F40537YG](#) [AXK5F44537YG](#) [AXK5F44547YG](#) [AXK5F50337YG](#) [AXK5F50347YG](#)
[AXK5F50537YG](#) [AXK5F50547YG](#) [AXK5F60337YG](#) [AXK5F60537YG](#) [AXK5F60547YG](#) [AXK5F70337YG](#)
[AXK5F70347YG](#) [AXK5F70537YG](#) [AXK5F70547YG](#) [AXK5F80337YG](#) [AXK5F80347YG](#) [AXK5F80537YG](#)
[AXK5F80547YG](#) [AXK6F00337YG](#) [AXK6F00347YG](#) [AXK6F00537YG](#) [AXK6F00547YG](#) [AXK6F10337YG](#)
[AXK6F10537YG](#) [AXK6F10547YG](#) [AXK6F12337YG](#) [AXK6F12347YG](#) [AXK6F12537YG](#) [AXK6F12547YG](#)
[AXK6F14337YG](#) [AXK6F14347YG](#) [AXK6F14537YG](#) [AXK6F14547YG](#) [AXK6F16337YG](#) [AXK6F16347YG](#)
[AXK6F16537YG](#) [AXK6F16547YG](#) [AXK6F18337YG](#) [AXK6F18347YG](#) [AXK6F20337YG](#) [AXK6F20347YG](#)
[AXK6F20537YG](#) [AXK6F20547YG](#) [AXK6F22337YG](#) [AXK6F22347YG](#)