

## Adjustable Reference Source

**FEATURES**

- The output voltage can be adjusted to 36V
- Low dynamic output impedance ,its typical value is 0.2Ω
- Trapping current capability is 1 to 100mA
- The typical value of the equivalent temperature factor in the whole temperature scope is 50 ppm/°C
- The effective temperature compensation in the working range of full temperature
- Low output noise voltage
- Fast on -state response
- 0.5% and 1% precision

**SOT—23**

- 1. BASE
- 2. EMITTER
- 3. COLLECTOR

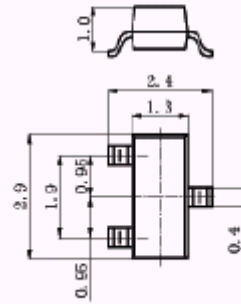

Unit: mm

**ABSOLUTE MAXIMUM RATINGS ( Operating temperature range applies unless otherwise specified )**

Parameter	SYMBOL	VALUE	UNITS
Cathode Voltage	$V_{KA}$	37	V
Cathode Current Range (Continuous)	$I_{KA}$	-100-+150	mA
Reference Input Current Range	$I_{ref}$	0.05-+10	mA
Power Dissipation	$P_D$	770	mW
Operating temperature	$T_{opr}$	0-70	°C
Storage temperature Range	$T_{stg}$	-65-+150°C	°C

**ELECTRICAL CHARACTERISTICS (  $T_{amb}=25^{\circ}C$  unless otherwise specified )**

Parameter	Symbol	Test conditions	MIN	TYP	MAX	UNIT	
Reference Input Voltage	$V_{ref}$	$V_{KA}=V_{REF}, I_{KA}=10mA$	2.440	2.495	2.550	V	
Deviation of reference input Voltage Over temperature (note)	$\Delta V_{ref}/\Delta T$	$V_{KA}=V_{REF}, I_{KA}=10mA$ $T_{min} \quad T_a \quad T_{max}$		4.5	17	mV	
Ratio Of Change in Reference Input Voltage to the change in Cathode Voltage	$\Delta V_{ref}/\Delta V_{KA}$	$I_{KA}=10mA$	$\Delta V_{KA}=10V \sim V_{REF}$		-1.0	-2.7	m V/V
			$\Delta V_{KA}=36V \sim 10V$		-0.5	-2.0	
Reference Input Current	$I_{ref}$	$I_{KA}=10mA, R_1=10K\Omega$ $R_2=\infty$		1.5	4	$\mu A$	
Deviation Of Reference Input Current Over Full Temperature Range	$\Delta I_{ref}/\Delta T$	$I_{KA}=10mA, R_1=10K\Omega$ $R_2=\infty$ $T_A=full \text{ Temperature}$		0.4	1.2	$\mu A$	
Minimum cathode current for Regulation	$I_{KA}(min)$	$V_{KA}=V_{REF}$		0.45	1.0	mA	
Off-state cathode Current	$I_{KA}(OFF)$	$V_{KA}=36V, V_{REF}=0$		0.05	1.0	$\mu A$	
Dynamic impedance	$Z_{KA}$	$V_{KA}=V_{REF}, I_{KA}=1 \text{ to } 100mA$ $f \quad 1.0KHz$		0.15	0.5	$\Omega$	

Note:  $T_{MIN}=0^{\circ}C, T_{MAX}=+70^{\circ}C$

TYPICAL APPLICATIONS

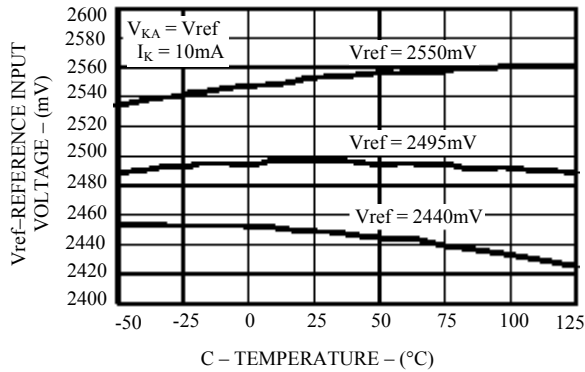

Figure 1.Reference Input Voltage vs. Temperature

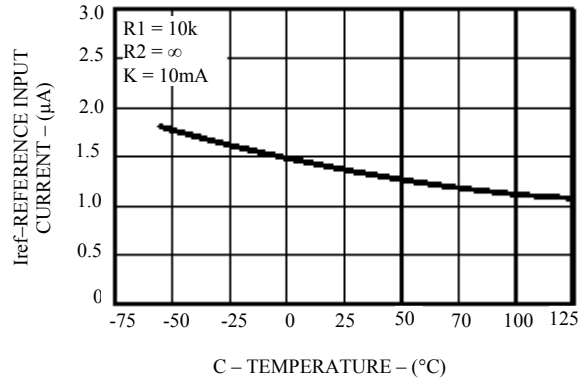

Figure 2.Reference Input Current vs. Temperature

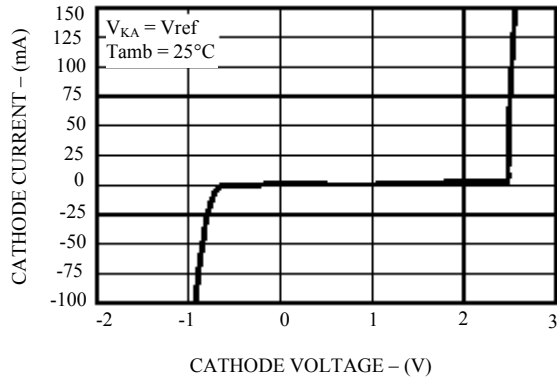

Figure 3.Cathode Current vs. Cathode Voltage

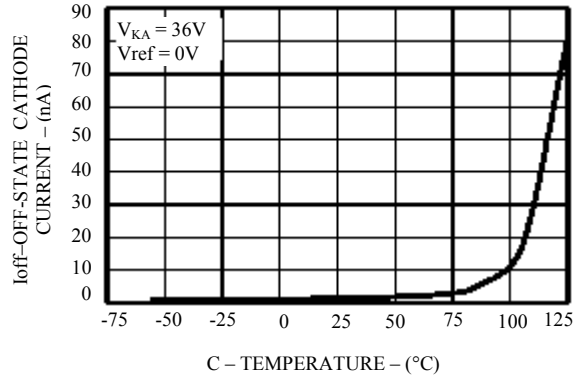

Figure 4.Off-State Cathode Current vs. Temperature

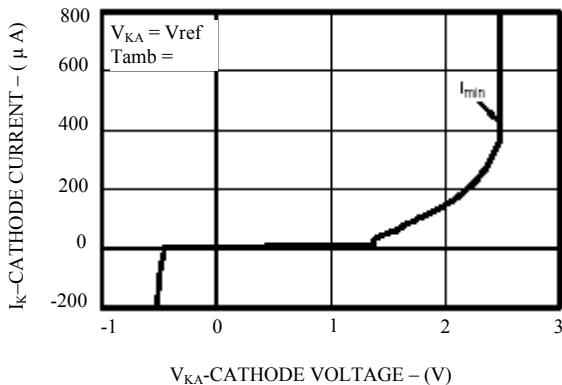

Figure 5.Cathode Current vs. Cathode Voltage

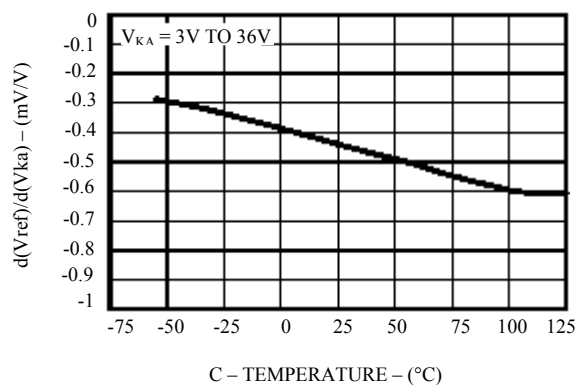

Figure 6.Ratio of Delta Reference Voltage to Delta Cathode Voltage over Temperature

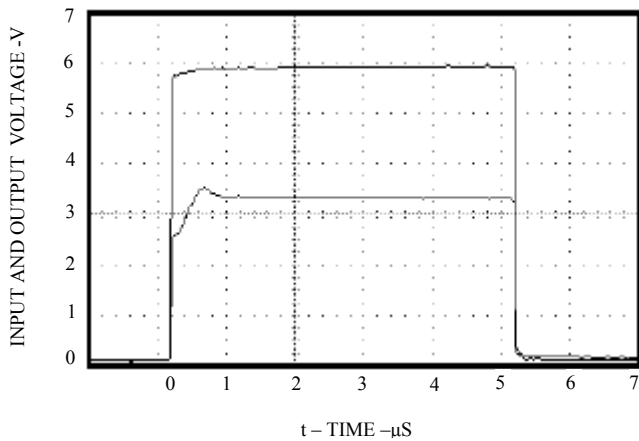

Figure 7. Pulse Response

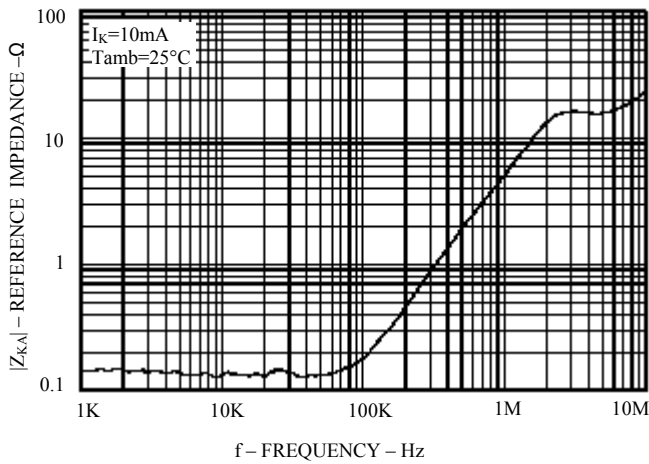
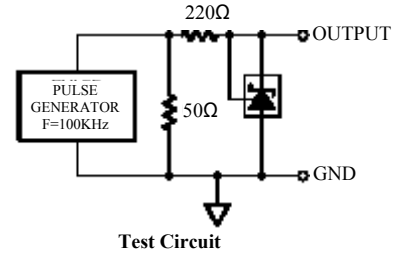

Figure 8. Reference Impedance vs. Frequency

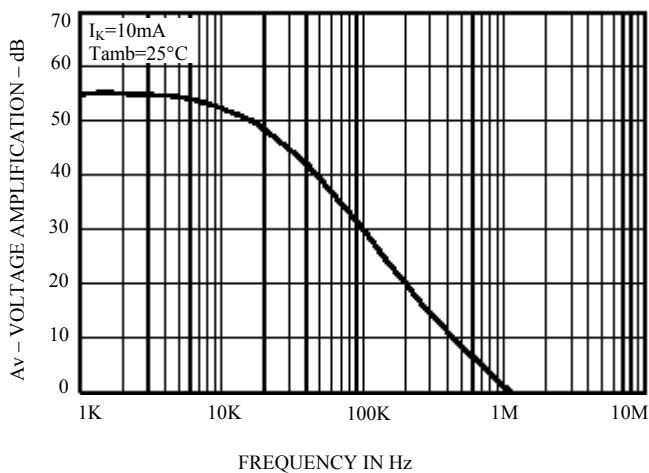
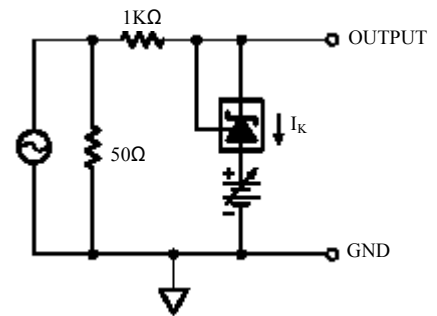
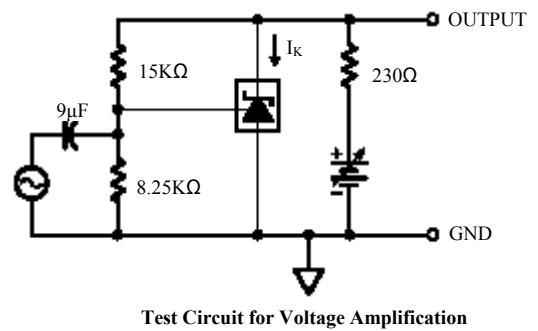

Figure 9. Small-Signal Voltage Amplification vs. Frequency



TYPICAL APPLICATIONS

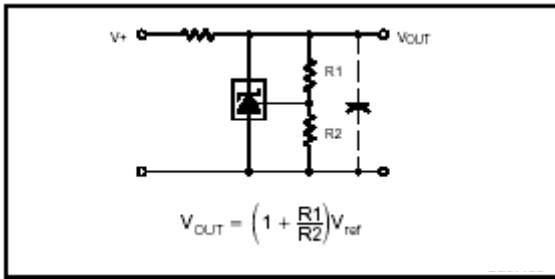

Figure 10. Shunt Regulator

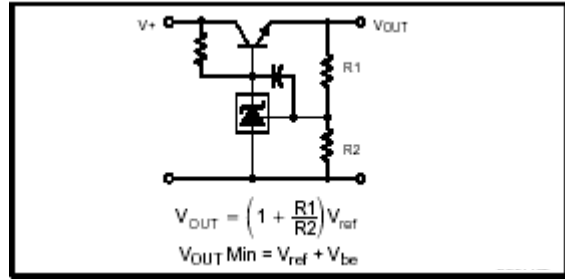

Figure 11. Series Pass Regulator

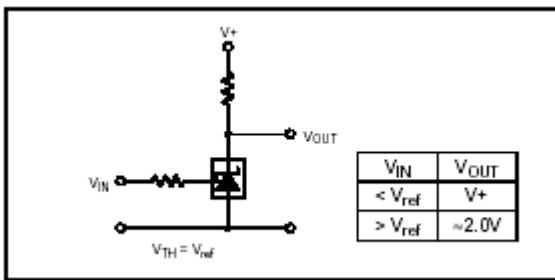

Figure 12. Single-Supply Comparator with Temperature-Compensated Threshold

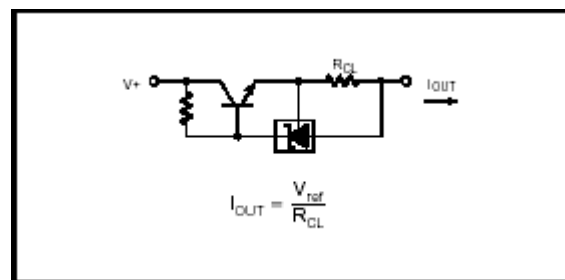

Figure 13. Constant Current Source

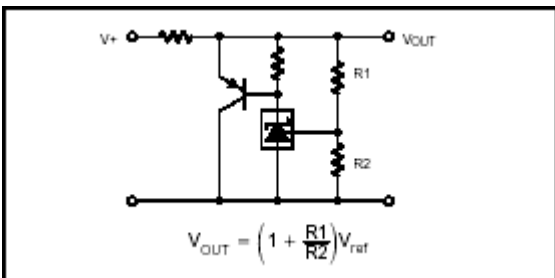

Figure 14. High Current Shunt

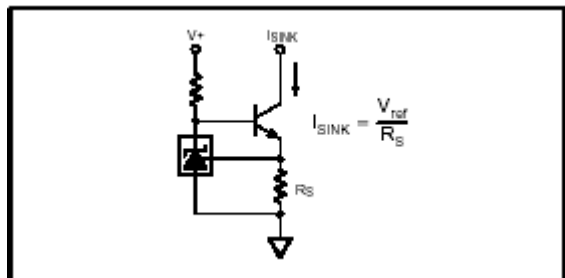

Figure 15. Constant Current Sink