

MATERIALS AND FINISHES

BODY: ZINC
PLATED: NICKEL

CENTER CONTACT: PHOSPOR BRONZE
PLATED: GOLD

OUTER CONTACT: BeCu
PLATED: NICKEL

CRIMP TUBE: BRASS
PLATED: NICKEL

OUTER CASING: NYLON
KEYING: SEE TABLE
COLOR: SEE TABLE

INSULATOR: TEFLON

CABLE: RG174, 188, & 316

RETENTION SPECIFICATION:

THE SHROUD WILL WITHSTAND A
LONGITUDINAL FORCE OF 24.73 POUNDS (110N)

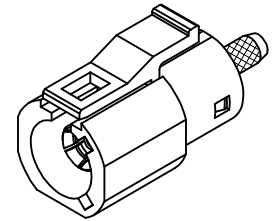
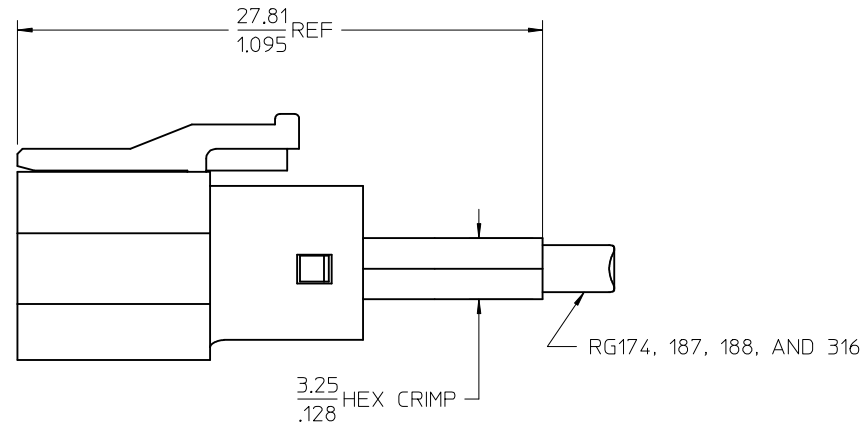

FAKRA
CONNECTOR
KEYING
CODE D SHOWN

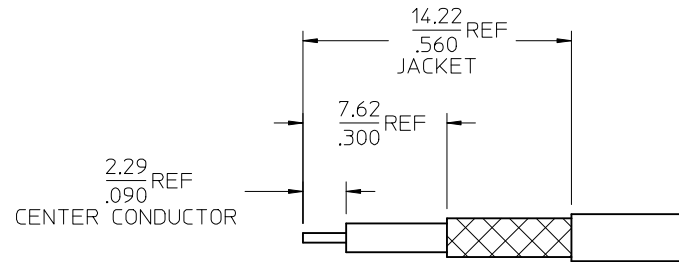
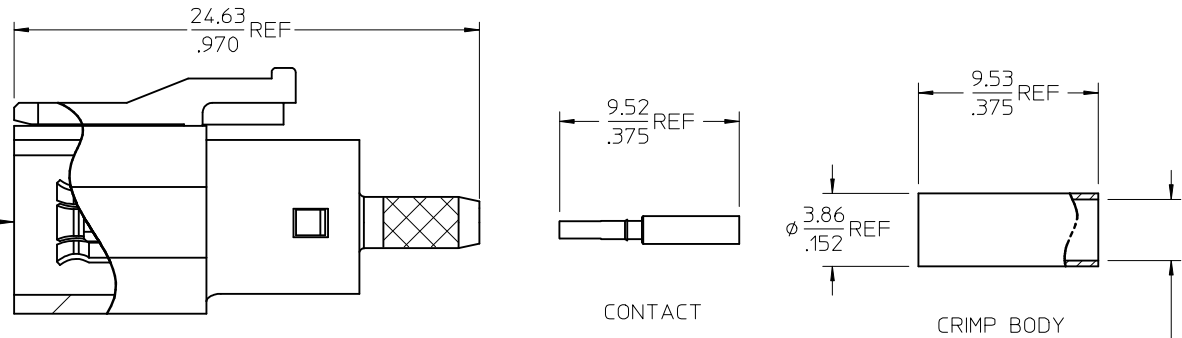

PART #SEE SHEET 2

PS-89675-331	PRODUCT SPECIFICATION
DIN 72594-1	INTERFACE SPECIFICATION
SPECIFICATION	DESCRIPTION

CHG: ADD PACKAGE
DRAWING
PER RF15-E1235
EC NO: URF2015-0454
DRWNLIN 2015/02/24
CHKD:
APPR: YCHENG 2015/04/21

QUALITY SYMBOLS

 GENERAL TOLERANCES (UNLESS SPECIFIED)

	mm	INCH
4 PLACES	± .005	± .0005
3 PLACES	± .003	± .0003
2 PLACES	± .002	± .0002
1 PLACE	± .001	± .0001

 ANGULAR ± 2 °
 DRAFT WHERE APPLICABLE
MUST REMAIN
WITHIN DIMENSIONS

DIMENSION STYLE
MM/IN
 DRAWN BY SSS DATE 2001/03/07
 CHECKED BY TEF DATE 2001/03/07
 APPROVED BY GMH DATE 2001/03/07
 MATERIAL NO. SEE SHT 2
 SIZE C

SCALE DESIGN UNITS METRIC
 THIRD ANGLE PROJECTION
 TITLE SMB PLUG, FAKRA
RG174,188,316 CABLE
SMB-JC

 MOLEX INCORPORATED
 DOCUMENT NO. SD-73415-291
 SHEET NO. 1 OF 3

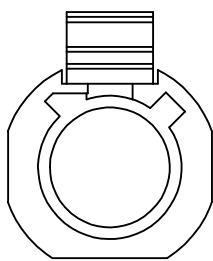

CODE - A

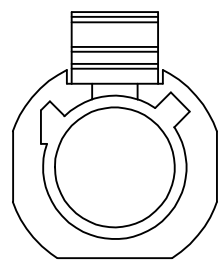

CODE - B

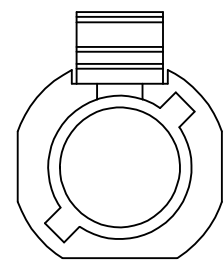

CODE - C

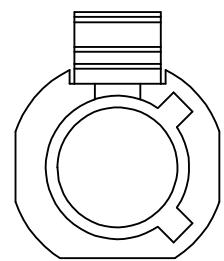

CODE - D

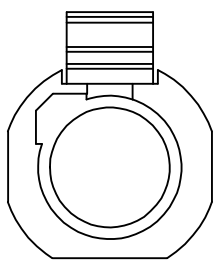

CODE - E

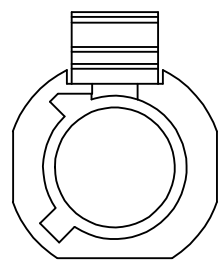

CODE - F

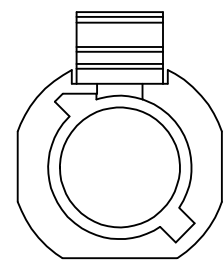

CODE - G

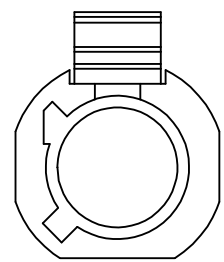

CODE - H

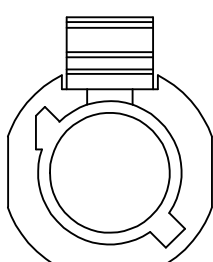

CODE - I

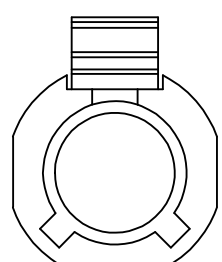

CODE - K

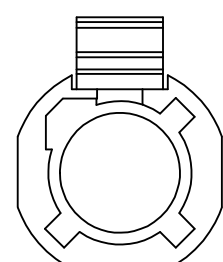

CODE - Z

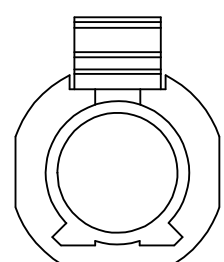

CODE - L

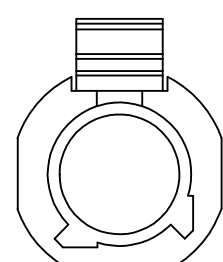

CODE - M

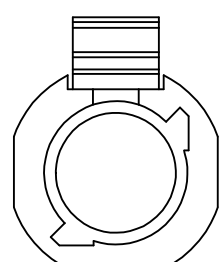

CODE - N

N	PASTEL GREEN	73415-2923
M	PASTEL ORANGE	73415-2922
L	CARMINE RED	73415-2921
Z	WATER BLUE	73415-2920
K	CURRY YELLOW	73415-2919
I	BEIGE	73415-2918
H	VIOLET	73415-2917
G	GRAY	73415-2916
F	BROWN	73415-2915
E	GREEN	73415-2914
D	BORDEAUXVIOLET	73415-2913
C	BLUE	73415-2912
B	CREAM WHITE	73415-2911
A	BLACK	73415-2910
KEYING CODE	COLOR	PART NO.

SEE SHEET 1 EC NO: URF2015-0454 DRWNLIN 2015/02/24 CHKD: APPR: YCHENG 2015/04/21	DESCRIPTION REV:
--	---------------------

QUALITY SYMBOLS ▽=0 ▽=0	GENERAL TOLERANCES (UNLESS SPECIFIED) mm INCH 4 PLACES ± --- ± --- 3 PLACES ± --- ± --- 2 PLACES ± --- ± --- 1 PLACE ± --- ± --- ANGULAR ± 2 ° DRAFT WHERE APPLICABLE MUST REMAIN WITHIN DIMENSIONS
-------------------------------	--

DIMENSION STYLE MM/IN DRAWN BY DATE SSS 2001/03/07 CHECKED BY DATE TEF 2001/03/07 APPROVED BY DATE GMH 2001/03/07 MATERIAL NO. SEE TABLE SIZE C

SCALE DESIGN UNITS METRIC THIRD ANGLE PROJECTION	TITLE SMB PLUG, FAKRA RG174,188,316 CABLE SMB-JC MOLEX INCORPORATED DOCUMENT NO. SD-73415-291 SHEET NO. 2 OF 3
---	--

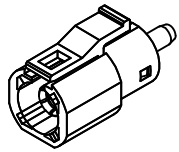

P/N 73415-291*

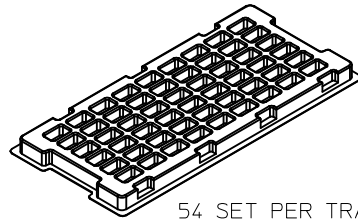

54 SET PER TRAY
TRAY P/N 89707-0220

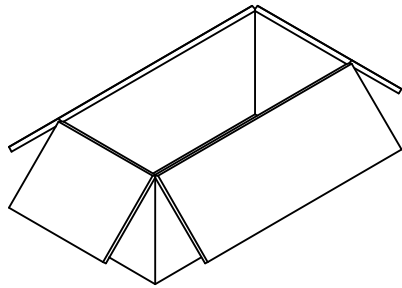

648 SET PER INNER
CARTON BOX
P/N 96707-0001

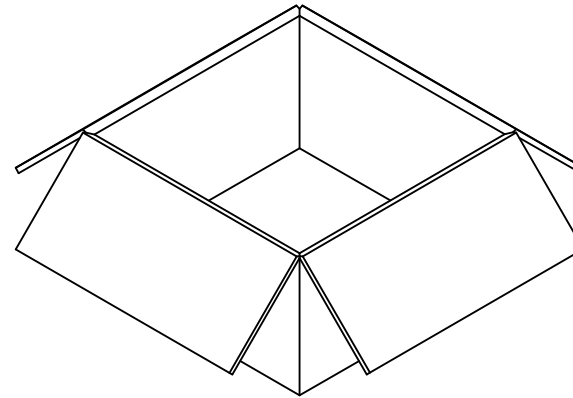

1296 SET PER OUTER
CARTON BOX
P/N 96708-0005

SEE SHEET 1 EC NO: URF2015-0454 DRW: LILIN 2015/02/24 CHKD: APPR: YCHENG 2015/04/21	QUALITY SYMBOLS	GENERAL TOLERANCES (UNLESS SPECIFIED)		DIMENSION STYLE		SCALE	DESIGN UNITS	THIRD ANGLE PROJECTION	
		mm	INCH	MM/IN			METRIC		
		4 PLACES ± --- ± ---	± --- ± ---	DRAWN BY	DATE	TITLE			
		3 PLACES ± --- ± ---	± --- ± ---	SSS	2001/03/07	SMB PLUG, FAKRA RG174,188,316 CABLE SMB-JC			
	2 PLACES ± --- ± ---	± --- ± ---	TEF	2001/03/07	APPROVED BY		DATE		MOLEX INCORPORATED
	1 PLACE ± --- ± ---	± --- ± ---	GMH	2001/03/07	MATERIAL NO.		DOCUMENT NO.		
		ANGULAR ± 2 °		DRAFT WHERE APPLICABLE MUST REMAIN WITHIN DIMENSIONS		SD-73415-291		SHEET NO. 3 OF 3	
B3	DESCRIPTION	SIZE		THIS DRAWING CONTAINS INFORMATION THAT IS PROPRIETARY TO MOLEX INCORPORATED AND SHOULD NOT BE USED WITHOUT WRITTEN PERMISSION					