

MIL-TYPE 1/4" PHONE PLUGS

2-CONDUCTOR

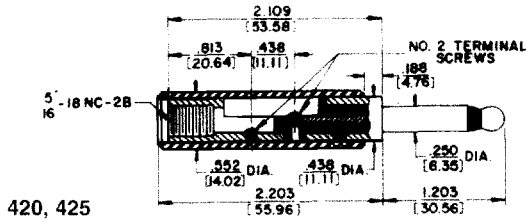

420, 425

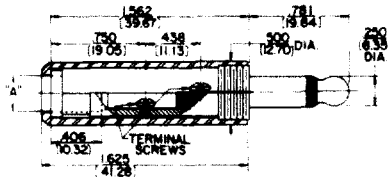

430

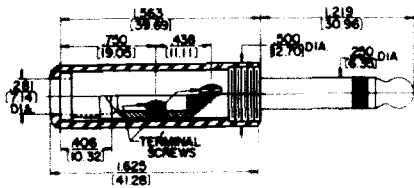

440, 445

3-CONDUCTOR

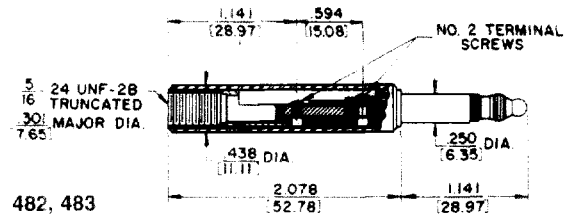

482, 483

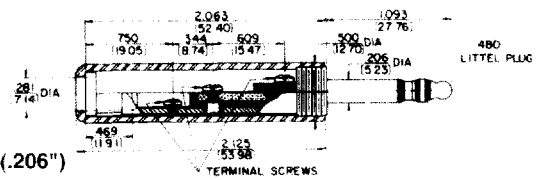

480 (.206")

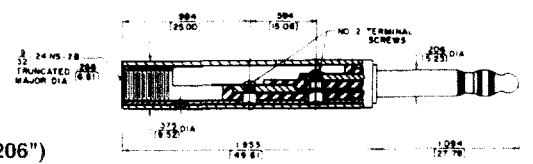

484 (.206")

FEATURES

Designed for high quality communication equipment to meet military requirements, This series features one-piece tip rod and one-piece sleeve and plug body, assembled together into a mode as inserts, providing a finished plug with complete continuity of thermoplastic insulation between top rod and plug sleeve. Internal (invisible externally) interlock mechanically engages the metal and plastic components providing a realistic lock to prevent parts shifting. Design and material in accordance with MIL-P-642(A), MIL part number molded or stamped on handle, manufacturer's trademark (as required by MIL specification) appears on plug body.

SPECIFICATIONS

Tip Rod, Body and Screws: Copper alloy, natural finish.

Terminals: Tinned copper alloy.

Insulation: Thermoplastic, per MIL-P-22985, Type II, Class 1.

Handles: Thermoplastic, Type 6, per MIL-M-20693, Type II.

Shielded; machined from copper alloy, nickel-plated.

STRAIN RELIEF CLAMP

For MIL-type Littell-Plug phone plugs. **P2380** conforms to Specification SC-A-7674-F - supplied with Plug Numbers 430, 440, 445 and 470. **P2381** meets Specification MS-35762 - supplied with Plug Number 480 and Extension-Jax® phone jack, Number 820.

DIMENSIONS ARE FOR REFERENCE ONLY $\frac{\text{inch}}{\text{mm}}$

NOTE: Contact your Switchcraft Representative for price and delivery.

LITTEL PLUG® PHONE PLUGS

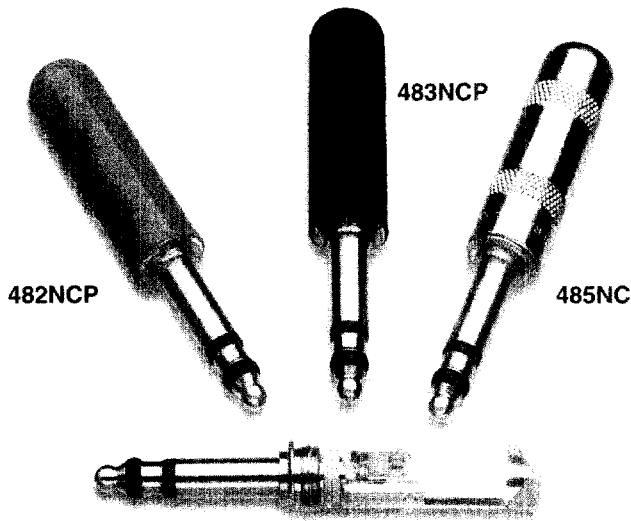

**New "NC" Series
Features Rugged
Heavy-Duty Cable
Clamp and Handle.**

FEATURES AND BENEFITS

- 3 conductor plug
- Designed for high quality communication equipment
- One-piece tip rod ensures electrical continuity
- Brass plug finger versions meet MIL specifications
- 'N' and 'NC' suffix versions have nickel-plated plug fingers, excellent for audio applications
- 'NC' suffix option has rugged, heavy duty cable clamp, solder terminals for easier solderability and assembly. Metal shielded handle

SPECIFICATIONS

Plug Finger: Brass, natural finish or nickel-plated

Terminals: Brass, electro tinned

Insulation: Ethyl cellulose, per MIL-P-22835, Type II, Class 1, or acetal resin

Handles: Plastic-nylon molding plastic, Type 6, per MIL-M-20693, Type II. Shielded metal handle with red, black or nickel finish

ORDERING INFORMATION

1. Order by part number.
2. Contact Switchcraft for more information.
3. Mating jacks available.

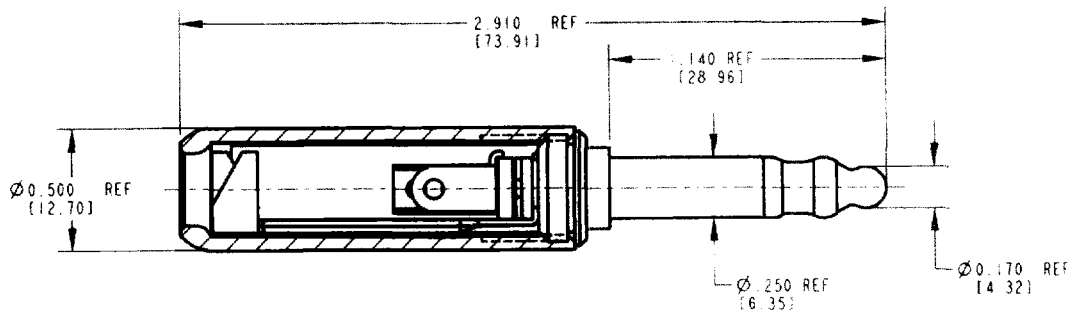

PART NO. 482NC, 482NCP, 483NC, 483NCP, 485NC

DIMENSIONS ARE FOR REFERENCE ONLY $\frac{\text{Inch}}{\text{mm}}$

NOTE: Contact your Switchcraft Representative for price and delivery.

MIL-TYPE 1/4" PHONE PLUGS (continued)

Part Number ¹	Conductors	Terminals	Typical Mating Jack	Handle	Handle Part Number	MIL Part Number	Notes
420	2	Screw ³	MT331	Black ⁴	◊T16762	M642/1-1	Old PJ-047B or Signal Corps PL-47. Similar to WECO-347D.
425	2	Screw ³	MT331	Red ⁴	T16761	M642/1-2	Old PJ-047R or Signal Corps PL-48. Similar to WECO-347C.
430	2	Screw ^{3 5}	820	Black	M10252	M642/3-1	Old PJ-054B or Signal Corps PL-354. Dimension "A" - .25 inches (See Drawing).
440	2	Screw ^{3 6}	MT331	Black	M1012	M642/4-1	Old PJ-055B or Signal Corps PL-55.
445	2	Screw ^{3 6}	MT331	Red	M-1013	M642/4-2	Old PJ-055R.
470	2	Screw ^{3 6}	MT331	Shielded	T125313	M642/4-3	Old PJ-055M or Signal Corps PL-125.
480	3	Screw ^{3 6}	MT342B	Black	M10271	M642/5-1	Old PJ-068 or Signal Corps PL-68. Finger diameter .206 inches.
482*	3	Screw ³	MT332B	Red ⁵	T16891	M642/2-2	Old PJ-051R or Signal Corps PL-51. Similar to WECO-310.
483*	3	Screw ³	MT332B	Black ⁵	◊T1973	M642/2-1	Old PJ-051B. JJ-022 and others
484	3	Screw ³	MT342B	Red ⁵	T1992	M642/8-1	Old PJ-309 or JJ-083. Finger diameter .206 inches. Similar to WECO-309.

1 Internal threads in the ends of Numbers 420, 425, 482 and 483 Littell-Plug phone plugs are intended for engagement by threading over the outer jacket of patch cord to provide cable anchor.

2 Switchcraft Part Numbers. See the jacks section for additional mating jacks.

3 Switchcraft replacement screw **P1070**. Terminal Number **P10695**. Two each required per plug except 3 each for Number 480.

4 Switchcraft replacement screw **T1677**. One screw required to mount handle.

5 Switchcraft replacement screw **T1990**. One screw required to mount handle.

6 Strain Relief "U" Clamp is separate part.

* Also available as nickel-plated. Specify 482N, 483N.

◊ Special order only. Contact Switchcraft.

480 Series Part Numbering Chart

Part number	.206" dia. finger	1/4" dia. finger	Brass finger	Nickel finger	Handle material	Red handle	Black handle	Nickel handle	Standard cable clamp	Large cable clamp
480	•		•		Plastic		•		•	
482		•	•		Plastic	•			•	
482N		•		•	Plastic	•			•	
482NC		•		•	Metal	•				•
482NCP		•		•	Plastic	•				•
483		•	•		Plastic		•		•	
483N		•		•	Plastic		•		•	
483NC		•		•	Metal		•			•
483NCP		•		•	Plastic		•			•
484	•		•		Plastic	•			•	
485NC		•		•	Metal			•		•

DIMENSIONS ARE FOR REFERENCE ONLY $\frac{\text{Inch}}{(\text{mm})}$

NOTE: Contact your Switchcraft Representative for price and delivery.