



2.5V 256/128K X 36 Synchronous Dual-port SRAM with 3.3V or 2.5V interface

**Features**

- True Dual-Port memory cells that allow simultaneous access of the same memory location
- Organisation: 262,144/131,072 x 36<sup>[1]</sup>
- Fully Synchronous, independent operation on both ports
- Selectable Pipeline or Flow-Through output mode
- Fast clock speeds in Pipeline output mode: 250 MHz operation (18Gbps bandwidth)
- Fast clock to data access: 2.8ns for Pipeline output mode
- Asynchronous output enable control
- Fast  $\overline{OE}$  access times: 2.8ns
- Double Cycle Deselect (DCD) for Pipeline Output Mode
- 18/17<sup>[1]</sup>-bit counter with Increment, Hold and Repeat features on each port
- Dual Chip enables on both ports for easy depth expansion
- Interrupt and Collision Detection Features
- 2.5 V power supply for the core
- LVTTTL compatible, selectable 3.3V or 2.5V power supply for I/Os, addresses, clock and control signals on each port
- Snooze modes for each port for standby operation
- 15mA typical standby current in power down mode
- Available in 256-pin Ball Grid Array (BGA), 208-pin Plastic Quad Flatpack (PQFP) and 208-pin fine pitch Ball Grid Array (fpBGA)
- Supports JTAG features compliant with IEEE 1149.1

Note:

1. AS9C25256M2036L/AS9C25128M2036L

**Selection guide**

Feature	-250	-200	-166	-133	Units
Minimum cycle time	4	5	6	7.5	ns
Maximum Pipeline clock frequency	250	200	166	133	MHz
Maximum Pipeline clock access time	2.8	3.4	3.6	4.2	ns
Maximum flow-through clock frequency	150	133	100	83	MHz
Maximum flow-through clock access time	6.5	7.5	10	12	ns
Maximum operating current	TBD	350	300	260	mA
Maximum snooze mode current	18	18	18	18	mA



Dual port logic block diagram

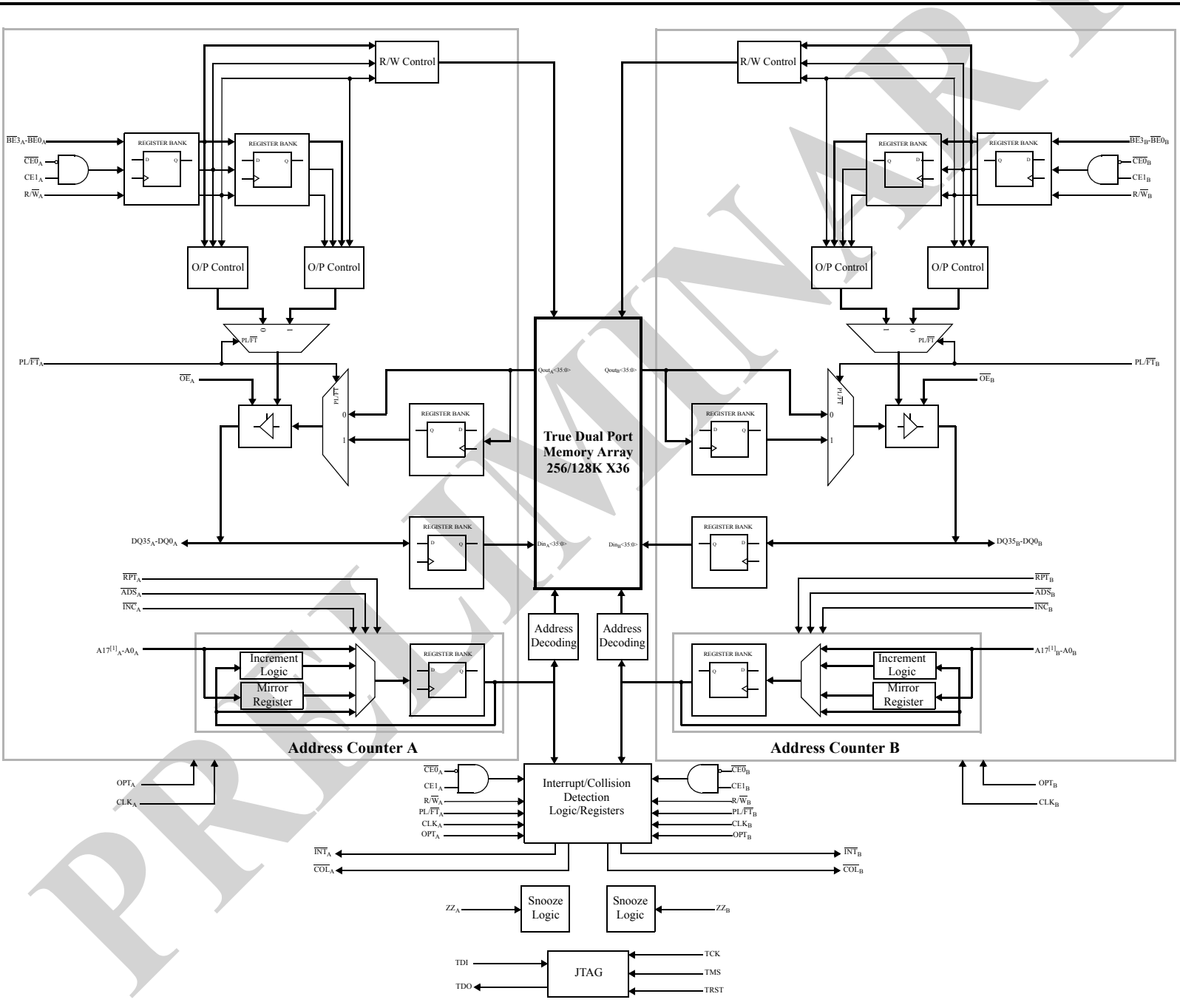

Note:  
1. Address A17 is a NC for AS9C25128M2036L



## General Description

The AS9C25256M2036L/AS9C25128M2036L is a high-speed CMOS 9/4.5-Mbit synchronous Dual-Port Static Random Access Memory device, organized as 262,144/131,072 x 36 bits. It incorporates a selectable Flow-Through/Pipeline output feature for user flexibility. Clock-to-data valid time is 2.8ns at 250 MHz for “Pipeline output” mode of operation.

Each port contains an 18/17 bit linear burst counter on the input address register that can loop through the whole address sequence. After externally loading the counter with the initial address, it can be Incremented or Held for the next cycle. A new address can also be Loaded or the “Previous Loaded” address can be re-accessed (Repeated) using counter controls (More description to follow). The Registers on control, data, and address inputs provide minimal setup and hold times.

The memory array utilizes Dual-Port memory cells to allow simultaneous access of any address from both ports. A particular port can write to a certain location while another port is reading from the same location, but the validity of read data is not guaranteed. However, the reading port is informed about the possible collision through its collision alert signal. The result of writing to the same location by more than one port at the same time is undefined.

The Asynchronous Output Enable input pin allows asynchronous disabling of output buffers at any given time. The Byte Enable inputs allow individual byte read/write operations (refer Byte Control Truth Table). An automatic power down feature, controlled by  $\overline{CE0}$  and CE1, permits the on-chip circuitry of each port to enter a very low standby power mode.

AS9C25256M2036L/AS9C25128M2036L can support an operating voltage of either 3.3V or 2.5V on either or both ports, which is controlled by the OPT pins. The power supply for the core of the device (VDD) is at 2.5V. This device is available in 256-pin Ball Grid Array (BGA), 208-pin fine pitch Ball Grid Array (fpBGA) and 208-pin Plastic Quad Flatpack (PQFP)

## Address Counter

The AS9C25256M2036L/AS9C25128M2036L carries an internal 18/17 bit address counter for each port which can loop through the entire memory array. The Address counter features are discussed below:

**Load:** Any required external address can be loaded on to the counter. This feature is similar to normal address load in conventional memories.

**Increment:** The address counter has the capability to internally increment the address value, potentially covering the entire memory array. Once the whole address space is completed, the counter will wrap around. The address counter is not initialized on Power-up, hence a known location has to be loaded before Increment operation.

**Hold:** The value of the counter register can be held for an unlimited number of clock cycles by de-asserting  $\overline{ADS}$ ,  $\overline{INC}$ , and  $\overline{RPT}$  inputs.

**Repeat:** The previously loaded address (loaded using a valid Load operation) can be re-accessed by asserting  $\overline{RPT}$  input. A separate 18/17 bit register called “Mirror register” is used to hold the last loaded address. This register is not initialized on Power-up, hence a known location has to be loaded before Repeat operation (Refer Counter control truth table for details).



Ball Assignment - 256-ball BGA

AS9C25256M2036L/AS9C25128M2036L

B - 256  
Top view

	1	2	3	4	5	6	7	8	9	10	11	12	13	14	15	16		
A	NC	TDI	NC	A17 <sup>[1]</sup> <sub>A</sub>	A14 <sub>A</sub>	A11 <sub>A</sub>	A8 <sub>A</sub>	$\overline{BE2}_A$	CE1 <sub>A</sub>	$\overline{OE}_A$	$\overline{INC}_A$	A5 <sub>A</sub>	A2 <sub>A</sub>	A0 <sub>A</sub>	NC	NC	A	
B	DQ18 <sub>A</sub>	NC	TDO	NC	A15 <sub>A</sub>	A12 <sub>A</sub>	A9 <sub>A</sub>	$\overline{BE3}_A$	$\overline{CE0}_A$	R/ $\overline{W}_A$	$\overline{RPT}_A$	A4 <sub>A</sub>	A1 <sub>A</sub>	VDD	DQ17 <sub>A</sub>	NC	B	
C	DQ18 <sub>B</sub>	DQ19 <sub>A</sub>	VSS	A16 <sub>A</sub>	A13 <sub>A</sub>	A10 <sub>A</sub>	A7 <sub>A</sub>	$\overline{BE1}_A$	$\overline{BE0}_A$	CLK <sub>A</sub>	$\overline{ADS}_A$	A6 <sub>A</sub>	A3 <sub>A</sub>	OPT <sub>A</sub>	DQ17 <sub>B</sub>	DQ16 <sub>A</sub>	C	
D	DQ20 <sub>B</sub>	DQ19 <sub>B</sub>	DQ20 <sub>A</sub>	PL/ $\overline{FT}_A$	VDDQ <sub>A</sub>	VDDQ <sub>A</sub>	VDDQ <sub>B</sub>	VDDQ <sub>B</sub>	VDDQ <sub>A</sub>	VDDQ <sub>A</sub>	VDDQ <sub>B</sub>	VDDQ <sub>B</sub>	VDD	DQ15 <sub>B</sub>	DQ15 <sub>A</sub>	DQ16 <sub>B</sub>	D	
E	DQ21 <sub>B</sub>	DQ21 <sub>A</sub>	DQ22 <sub>A</sub>	VDDQ <sub>A</sub>	VDD	VDD	$\overline{INT}_A$	VSS	VSS	VSS	VDD	VDD	VDDQ <sub>B</sub>	DQ13 <sub>A</sub>	DQ14 <sub>A</sub>	DQ14 <sub>B</sub>	E	
F	DQ23 <sub>A</sub>	DQ22 <sub>B</sub>	DQ23 <sub>B</sub>	VDDQ <sub>A</sub>	VDD	NC	$\overline{COL}_A$	VSS	VSS	VSS	VSS	VDD	VDDQ <sub>B</sub>	DQ12 <sub>B</sub>	DQ13 <sub>B</sub>	DQ12 <sub>A</sub>	F	
G	DQ24 <sub>B</sub>	DQ24 <sub>A</sub>	DQ25 <sub>A</sub>	VDDQ <sub>B</sub>	VSS	VSS	VSS	VSS	VSS	VSS	VSS	VSS	VDDQ <sub>A</sub>	DQ10 <sub>A</sub>	DQ11 <sub>A</sub>	DQ11 <sub>B</sub>	G	
H	DQ26 <sub>A</sub>	DQ25 <sub>B</sub>	DQ26 <sub>B</sub>	VDDQ <sub>B</sub>	VSS	VSS	VSS	VSS	VSS	VSS	VSS	VSS	VDDQ <sub>A</sub>	DQ9 <sub>B</sub>	DQ9 <sub>A</sub>	DQ10 <sub>B</sub>	H	
J	DQ27 <sub>A</sub>	DQ28 <sub>B</sub>	DQ27 <sub>B</sub>	VDDQ <sub>A</sub>	ZZ <sub>B</sub>	VSS	VSS	VSS	VSS	VSS	VSS	VSS	ZZ <sub>A</sub>	VDDQ <sub>B</sub>	DQ8 <sub>B</sub>	DQ7 <sub>B</sub>	DQ8 <sub>A</sub>	J
K	DQ29 <sub>B</sub>	DQ29 <sub>A</sub>	DQ28 <sub>A</sub>	VDDQ <sub>A</sub>	VSS	VSS	VSS	VSS	VSS	VSS	VSS	VSS	VDDQ <sub>B</sub>	DQ6 <sub>B</sub>	DQ6 <sub>A</sub>	DQ7 <sub>A</sub>	K	
L	DQ30 <sub>A</sub>	DQ31 <sub>B</sub>	DQ30 <sub>B</sub>	VDDQ <sub>B</sub>	VDD	NC	$\overline{COL}_B$	VSS	VSS	VSS	VSS	VDD	VDDQ <sub>A</sub>	DQ5 <sub>A</sub>	DQ4 <sub>B</sub>	DQ5 <sub>B</sub>	L	
M	DQ32 <sub>B</sub>	DQ32 <sub>A</sub>	DQ31 <sub>A</sub>	VDDQ <sub>B</sub>	VDD	VDD	$\overline{INT}_B$	VSS	VSS	VSS	VDD	VDD	VDDQ <sub>A</sub>	DQ3 <sub>B</sub>	DQ3 <sub>A</sub>	DQ4 <sub>A</sub>	M	
N	DQ33 <sub>A</sub>	DQ34 <sub>B</sub>	DQ33 <sub>B</sub>	PL/ $\overline{FT}_B$	VDDQ <sub>B</sub>	VDDQ <sub>B</sub>	VDDQ <sub>A</sub>	VDDQ <sub>A</sub>	VDDQ <sub>B</sub>	VDDQ <sub>B</sub>	VDDQ <sub>A</sub>	VDDQ <sub>A</sub>	VDD	DQ2 <sub>A</sub>	DQ1 <sub>B</sub>	DQ2 <sub>B</sub>	N	
P	DQ35 <sub>B</sub>	DQ34 <sub>A</sub>	TMS	A16 <sub>B</sub>	A13 <sub>B</sub>	A10 <sub>B</sub>	A7 <sub>B</sub>	$\overline{BE1}_B$	$\overline{BE0}_B$	CLK <sub>B</sub>	$\overline{ADS}_B$	A6 <sub>B</sub>	A3 <sub>B</sub>	DQ0 <sub>A</sub>	DQ0 <sub>B</sub>	DQ1 <sub>A</sub>	P	
R	DQ35 <sub>A</sub>	NC	$\overline{TRST}$	NC	A15 <sub>B</sub>	A12 <sub>B</sub>	A9 <sub>B</sub>	$\overline{BE3}_B$	$\overline{CE0}_B$	R/ $\overline{W}_B$	$\overline{RPT}_B$	A4 <sub>B</sub>	A1 <sub>B</sub>	OPT <sub>B</sub>	NC	NC	R	
T	NC	TCK	NC	A17 <sup>[1]</sup> <sub>B</sub>	A14 <sub>B</sub>	A11 <sub>B</sub>	A8 <sub>B</sub>	$\overline{BE2}_B$	CE1 <sub>B</sub>	$\overline{OE}_B$	$\overline{INC}_B$	A5 <sub>B</sub>	A2 <sub>B</sub>	A0 <sub>B</sub>	NC	NC	T	
	1	2	3	4	5	6	7	8	9	10	11	12	13	14	15	16		

Note:

1. Address A17 is a NC for AS9C25128M2036L



Ball Assignment - 208-ball fpBGA

	1	2	3	4	5	6	7	8	9	10	11	12	13	14	15	16	17		
A	DQ19 <sub>A</sub>	DQ18 <sub>A</sub>	VSS	TDO	$\overline{\text{COL}}_A$	A16 <sub>A</sub>	A12 <sub>A</sub>	A8 <sub>A</sub>	$\overline{\text{BE}}1_A$	VDD	CLK <sub>A</sub>	$\overline{\text{INC}}_A$	A4 <sub>A</sub>	A0 <sub>A</sub>	OPT <sub>A</sub>	DQ17 <sub>A</sub>	VSS	A	
B	DQ20 <sub>B</sub>	VSS	DQ18 <sub>B</sub>	TDI	A17 <sup>[1]</sup> <sub>A</sub>	A13 <sub>A</sub>	A9 <sub>A</sub>	$\overline{\text{BE}}2_A$	$\overline{\text{CE}}0_A$	VSS	$\overline{\text{ADS}}_A$	A5 <sub>A</sub>	A1 <sub>A</sub>	NC	VDDQ <sub>B</sub>	DQ16 <sub>A</sub>	DQ15 <sub>B</sub>	B	
C	VDDQ <sub>A</sub>	DQ19 <sub>B</sub>	VDDQ <sub>B</sub>	PL/ $\overline{\text{FT}}_A$	$\overline{\text{INT}}_A$	A14 <sub>A</sub>	A10 <sub>A</sub>	$\overline{\text{BE}}3_A$	CE1 <sub>A</sub>	VSS	R/ $\overline{\text{W}}_A$	A6 <sub>A</sub>	A2 <sub>A</sub>	VDD	DQ16 <sub>B</sub>	DQ15 <sub>A</sub>	VSS	C	
D	DQ22 <sub>A</sub>	VSS	DQ21 <sub>A</sub>	DQ20 <sub>A</sub>	A15 <sub>A</sub>	A11 <sub>A</sub>	A7 <sub>A</sub>	$\overline{\text{BE}}0_A$	VDD	$\overline{\text{OE}}_A$	$\overline{\text{RPT}}_A$	A3 <sub>A</sub>	VDD	DQ17 <sub>B</sub>	VDDQ <sub>A</sub>	DQ14 <sub>A</sub>	DQ14 <sub>B</sub>	D	
E	DQ23 <sub>A</sub>	DQ22 <sub>B</sub>	VDDQ <sub>B</sub>	DQ21 <sub>B</sub>	AS9C25256M2036L/AS9C25128M2036L F - 208 Top view										DQ12 <sub>A</sub>	DQ13 <sub>B</sub>	VSS	DQ13 <sub>A</sub>	E
F	VDDQ <sub>A</sub>	DQ23 <sub>B</sub>	DQ24 <sub>A</sub>	VSS											VSS	DQ12 <sub>B</sub>	DQ11 <sub>A</sub>	VDDQ <sub>B</sub>	F
G	DQ26 <sub>A</sub>	VSS	DQ25 <sub>A</sub>	DQ24 <sub>B</sub>											DQ9 <sub>A</sub>	VDDQ <sub>A</sub>	DQ10 <sub>A</sub>	DQ11 <sub>B</sub>	G
H	VDD	DQ26 <sub>B</sub>	VDDQ <sub>B</sub>	DQ25 <sub>B</sub>											VDD	DQ9 <sub>B</sub>	VSS	DQ10 <sub>B</sub>	H
J	VDDQ <sub>A</sub>	VDD	VSS	ZZ <sub>B</sub>											ZZ <sub>A</sub>	VDD	VSS	VDDQ <sub>B</sub>	J
K	DQ28 <sub>B</sub>	VSS	DQ27 <sub>B</sub>	VSS											DQ7 <sub>B</sub>	VDDQ <sub>A</sub>	DQ8 <sub>B</sub>	VSS	K
L	DQ29 <sub>B</sub>	DQ28 <sub>A</sub>	VDDQ <sub>B</sub>	DQ27 <sub>A</sub>											DQ6 <sub>B</sub>	DQ7 <sub>A</sub>	VSS	DQ8 <sub>A</sub>	L
M	VDDQ <sub>A</sub>	DQ29 <sub>A</sub>	DQ30 <sub>B</sub>	VSS											VSS	DQ6 <sub>A</sub>	DQ5 <sub>B</sub>	VDDQ <sub>B</sub>	M
N	DQ31 <sub>A</sub>	VSS	DQ31 <sub>B</sub>	DQ30 <sub>A</sub>											DQ3 <sub>B</sub>	VDDQ <sub>A</sub>	DQ4 <sub>B</sub>	DQ5 <sub>A</sub>	N
P	DQ32 <sub>B</sub>	DQ32 <sub>A</sub>	VDDQ <sub>B</sub>	DQ35 <sub>B</sub>											$\overline{\text{TRST}}$	A16 <sub>B</sub>	A12 <sub>B</sub>	A8 <sub>B</sub>	$\overline{\text{BE}}1_B$
R	VSS	DQ33 <sub>A</sub>	DQ34 <sub>B</sub>	TCK	A17 <sup>[1]</sup> <sub>B</sub>	A13 <sub>B</sub>	A9 <sub>B</sub>	$\overline{\text{BE}}2_B$	$\overline{\text{CE}}0_B$	VSS	$\overline{\text{ADS}}_B$	A5 <sub>B</sub>	A1 <sub>B</sub>	NC	VDDQ <sub>A</sub>	DQ1 <sub>B</sub>	VDDQ <sub>B</sub>	R	
T	DQ33 <sub>B</sub>	DQ34 <sub>A</sub>	VDDQ <sub>A</sub>	TMS	$\overline{\text{INT}}_B$	A14 <sub>B</sub>	A10 <sub>B</sub>	$\overline{\text{BE}}3_B$	CE1 <sub>B</sub>	VSS	R/ $\overline{\text{W}}_B$	A6 <sub>B</sub>	A2 <sub>B</sub>	VSS	DQ0 <sub>B</sub>	VSS	DQ2 <sub>B</sub>	T	
U	VSS	DQ35 <sub>A</sub>	PL/ $\overline{\text{FT}}_B$	$\overline{\text{COL}}_B$	A15 <sub>B</sub>	A11 <sub>B</sub>	A7 <sub>B</sub>	$\overline{\text{BE}}0_B$	VDD	$\overline{\text{OE}}_B$	$\overline{\text{RPT}}_B$	A3 <sub>B</sub>	A0 <sub>B</sub>	VDD	OPT <sub>B</sub>	DQ0 <sub>A</sub>	DQ1 <sub>A</sub>	U	
	1	2	3	4	5	6	7	8	9	10	11	12	13	14	15	16	17		

Note:

1. Address A17 is a NC for AS9C25128M2036L



Pin Assignment - 208-pin PQFP

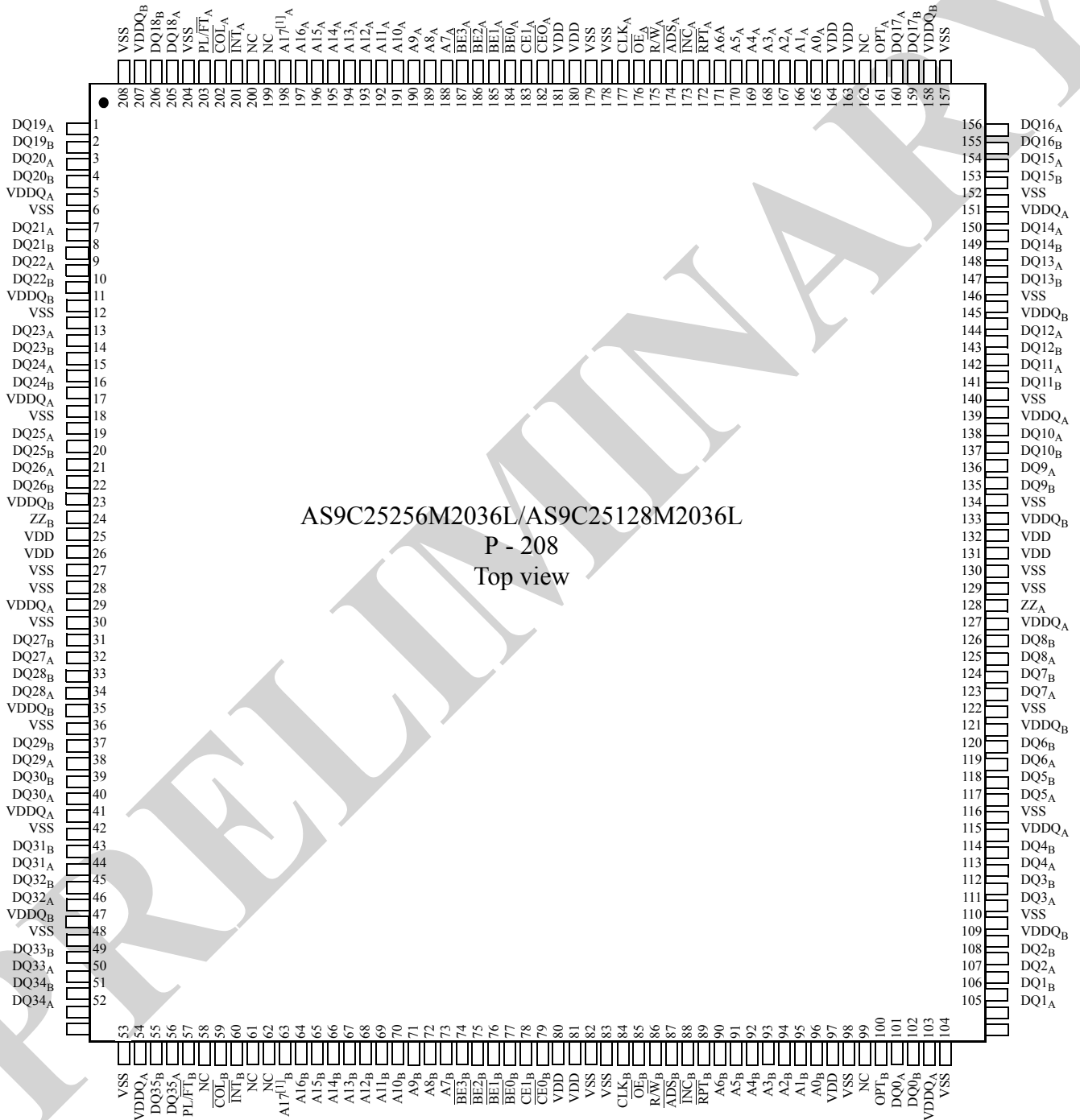

Note:

- Address A17 is a NC for AS9C25128M2036L



## Signal description

Signal		I/O	Properties	Description	Notes
Port A	Port B				
CLK <sub>A</sub>	CLK <sub>B</sub>	I	CLOCK	Clock. Each port has an independent Clock input that can be of different frequencies. All inputs except OE <sub>x</sub> and ZZ <sub>x</sub> are synchronous to the corresponding port's clock and must meet setup and hold time about the rising edge of the clock.	1
A0 <sub>A</sub> - A17 <sub>A</sub>	A0 <sub>B</sub> - A17 <sub>B</sub>	I	SYNC	External Address. Sampled on the rising edge of corresponding port clock	6
DQ0 <sub>A</sub> - DQ35 <sub>A</sub>	DQ0 <sub>B</sub> - DQ35 <sub>B</sub>	I/O	SYNC	Bidirectional data pins	
CE0 <sub>A</sub> , CE1 <sub>A</sub>	CE0 <sub>B</sub> , CE1 <sub>B</sub>	I	SYNC	Chip enable inputs. Active low and high, respectively. Sampled on the rising edge of corresponding port clock.	
R/W <sub>A</sub>	R/W <sub>B</sub>	I	SYNC	Read/Write enable. Drive this pin LOW to write to, or HIGH to Read from the memory array.	
BE0 <sub>A</sub> - BE3 <sub>A</sub>	BE0 <sub>B</sub> - BE3 <sub>B</sub>	I	SYNC	Byte Enable Inputs. Active low. Asserting these signals enables Read and Write operations to the corresponding bytes of the memory array. (Refer Byte Control Truth Table)	
ADS <sub>A</sub>	ADS <sub>B</sub>	I	SYNC	Address Strobe Enable. Active low. Loads external address onto the counter. (Refer Counter Control Truth Table)	
INC <sub>A</sub>	INC <sub>B</sub>	I	SYNC	Address Counter Increment. Active low. Increments the counter value. (Refer Counter Control Truth Table)	
RPT <sub>A</sub>	RPT <sub>B</sub>	I	SYNC	Address Counter Repeat. Active low. Reloads the counter with the previously loaded external address. (Refer Counter Control Truth Table)	
OE <sub>A</sub>	OE <sub>B</sub>	I	ASYNC	Asynchronous output enable. I/O pins are driven when the OE is low and the chip is in Read mode. A high on OE tristates the I/O pins.	
ZZ <sub>A</sub>	ZZ <sub>B</sub>	I	ASYNC	Snooze Mode Input. Places the device in low power mode. Data is retained. This pin has an internal pull-down and can be floating.	
PL/FT <sub>A</sub>	PL/FT <sub>B</sub>	I	STATIC	Pipeline/Flow-Through Select. When low, enables single register flow-through mode. When high, enables double register Pipeline mode. This pin has an internal pull-up and can be left floating to operate in pipeline mode.	
OPT <sub>A</sub>	OPT <sub>B</sub>	I	STATIC	VDDQ <sub>x</sub> Option. OPT <sub>x</sub> selects the operating voltage levels for the I/Os, addresses, clock, and controls on that port. This pin has an internal pull-up and can be left floating to operate in 3.3V mode.	1,2,3
INT <sub>A</sub>	INT <sub>B</sub>	O	SYNC	Interrupt Flag. Used for message passing between two ports. (Refer Interrupt Logic Truth Table)	
COL <sub>A</sub>	COL <sub>B</sub>	O	SYNC	Collision Alert Flag. Used to indicate collision during simultaneous memory access to the same location by both the ports (Refer Collision Detection Truth Table)	
VDDQ <sub>A</sub>	VDDQ <sub>B</sub>	I	POWER	Power to I/O bus. Can be 3.3V or 2.5V depending on OPT <sub>x</sub> input.	1,2,3
VDD		I	POWER	Power Inputs (To be connected to 2.5V Power supply)	2
VSS		I	GROUND	Ground Inputs (To be connected to Ground supply)	
TCK		I	CLOCK (JTAG)	JTAG Test Clock Input. All JTAG signals except TRST are synchronous to this clock.	4,5
TDI		I	SYNC (JTAG)	JTAG Test Data Input. Data on the TDI input will be shifted serially into selected registers.	4,5
TDO		O	SYNC (JTAG)	JTAG Test Data Output. TDO transitions occur on the falling edge of TCK. TDO is normally tristated except when the captured data is shifted out of the JTAG TAP.	5
TMS		I	SYNC (JTAG)	JTAG Test Mode Select Input. It controls the JTAG TAP state machine. State machine transitions occur on the rising edge of TCK.	4,5
TRST		I	ASYNC (JTAG)	JTAG Test Reset Input. Asynchronous input used to initialize TAP controller.	4,5

Notes:

- Subscript 'x' represents 'A' for Port A and 'B' for Port B.
- OPT<sub>x</sub>, VDDQ<sub>x</sub> and VDD must be set to appropriate operating levels before applying inputs on the I/Os and controls for that port.
- OPT<sub>x</sub> = VDD (2.5V) implies that corresponding port's I/Os, addresses, clock, and controls will operate at 3.3V level and VDDQ<sub>x</sub> must be supplied at 3.3V. OPT<sub>x</sub> = VSS (0V) implies that corresponding port's I/Os, addresses, clock, and controls will operate at 2.5V level and VDDQ<sub>x</sub> must be supplied at 2.5V.
- Each port can independently operate on either of the VDDQ levels.
- If unused JTAG inputs may be left unconnected.
- JTAG is not supported in PQFP package.
- Address A17 is a NC for AS9C25128M2036L



### Byte control truth table<sup>[1,2,3,4,5]</sup>

$\overline{BE3}$	$\overline{BE2}$	$\overline{BE1}$	$\overline{BE0}$	CLK	Mode
H	H	H	H	L to H	All Bytes Deselected - NOP
H	H	H	L	L to H	Read or Write Byte 0
H	H	L	H	L to H	Read or Write Byte 1
H	L	H	H	L to H	Read or Write Byte 2
L	H	H	H	L to H	Read or Write Byte 3

Notes:

1. L = low, H = high
2.  $\overline{CE0} = L$ ,  $CE1 = H$  (Chip in Select mode)
3.  $R/\overline{W} = H$  for a Read operation,  $R/\overline{W} = L$  for a Write operation
4. Byte 3 - DQ[35:27], Byte 2 - DQ[26:18], Byte 1 - DQ[17:9], Byte 0 - DQ[8:0]
5. More than one byte enable may be simultaneously asserted

### Read/write control truth table<sup>[1,4]</sup>

$\overline{CE}^{[2]}$	$R/\overline{W}$	$\overline{BE}_n^{[3]}$	CLK	Operation	$DQ_n[0:8]^{[3,7]}$
H	X	X	L to H	Chip Deselect	Hi-Z <sup>[5,9]</sup>
L	X	H	L to H	Byte Deselect	Hi-Z <sup>[5,9]</sup>
L	L	L	L to H	Byte Write	Din <sup>[6]</sup>
L	H	L	L to H	Byte Read	Qout <sup>[5,8]</sup>

Notes:

1. L = low, H = high, X = don't care
2.  $\overline{CE}$  is an internal signal.  $\overline{CE} = H$  implies 'Chip is Deselected' ( $\overline{CE0} = H$  or  $CE1 = L$ ),  $\overline{CE} = L$  implies 'Chip is Selected' ( $\overline{CE0} = L$  and  $CE1 = H$ )
3.  $\overline{BE}_n$  refers to any one of the 4 byte controls [ $n = 3, 2, 1$  or  $0$ ] and  $DQ_n$  refers to the corresponding Byte
4. Snooze de-asserted ( $ZZ=L$ )
5. True in flow-through mode. For Pipeline mode there will be a 1 cycle latency [refer timing diagrams]
6. For a write command issued before the completion of a read command,  $\overline{OE}$  must be HIGH before the input data setup time and held HIGH throughout the input data hold time.
7. All DQs are tristated on power-up
8.  $\overline{OE}$  should be asserted ( $\overline{OE} = L$ ) (Refer Read timing waveform)
9. In pipeline mode the DQs are HighZ-ed in the same cycle if  $R/\overline{W}=L$

### Counter control truth table<sup>[1,2,5,6]</sup>

CLK	$\overline{ADS}^{[3]}$	$\overline{INC}^{[3]}$	$\overline{RPT}^{[3]}$	External Address	Previous Address Accessed	Mirror Register Content <sup>[4]</sup>	Address Accessed	Operation
L to H	L	X	H	An	X	An	An	Load <sup>[4]</sup>
L to H	H	L	H	X	An	Am	An + 1	Increment
L to H	H	H	H	X	An	Am	An	Hold
L to H	X	X	L	X	X	Am	Am	Repeat

Notes:

1. L = low, H = high, X = don't care
2. Cycle can be Read, Write or Deselect (Controlled by appropriate setting of  $R/\overline{W}$ ,  $\overline{CE0}$ ,  $CE1$  and  $\overline{BE}_n$ )
3.  $\overline{ADS}$ ,  $\overline{INC}$ ,  $\overline{RPT}$  are independent of all other memory controls including  $R/\overline{W}$ ,  $\overline{CE0}$ ,  $CE1$  and  $\overline{BE}_n$  (i.e Counter works independent of  $R/\overline{W}$ ,  $\overline{CE0}$ ,  $CE1$  and  $\overline{BE}_n$ )
4. The 'Mirror register' used for the Repeat operation is loaded with External address during every valid  $\overline{ADS}$  access. "Am" refers to the mirror register content.
5. Clock to the counter is disabled during Snooze mode (True for both ports).
6. The counter and the mirror registers are not initialized on Power-up (refer Counter description).





### Package Thermal Resistance

Description	Conditions		Symbol	Typical	Units
Thermal Resistance (junction to ambient) <sup>[1]</sup>	Test conditions follow standard test methods and procedures for measuring thermal impedance, per EIA/JESD51	BGA	$\theta_{JA}$	TBD	°C/W
		fpBGA	$\theta_{JA}$	TBD	°C/W
		PQFP	$\theta_{JA}$	TBD	°C/W
Thermal Resistance (junction to top of case) <sup>[1]</sup>			$\theta_{JC}$	TBD	°C/W

Notes:

1. This parameter is sampled.

### Capacitance<sup>[1]</sup> ( $T_A = +25\text{ °C}$ , $F = 1.0\text{ Mhz}$ )<sup>[2]</sup>

Parameter	Symbol	Signals	Test Condition <sup>[3]</sup>	BGA (Max)	fpBGA (Max)	PQFP (Max)	Unit
Input Capacitance	$C_{IN}$	Address and Control pins	$V_{IN} = L$ to H or H to L	TBD	TBD	TBD	pF
Output Capacitance	$C_{OUT}$	Flag Output pins	$V_{OUT} = L$ to H or H to L	TBD	TBD	TBD	pF
I/O Capacitance	$C_{I/O}$	I/O pins	$V_{I/O} = L$ to H or H to L	TBD	TBD	TBD	pF

Notes:

1. Sampled, not 100% tested
2.  $T_A$  stands for 'Ambient temperature'.
3. L = 0V; H = 3V

### Absolute maximum ratings<sup>[1]</sup>

Parameter	Symbol	Rating		Unit
		Min	Max	
Core supply voltage relative to VSS	VDD	-0.5	3.6	V
I/O supply voltage relative to VSS	VDDQ	-0.3	3.9	V
Input and I/O voltage relative to VSS	$V_{IN}$	-0.3	VDDQ + 0.3	V
Power Dissipation	$P_D$	-	TBD	W
Short circuit output current	$I_{OUT}$	-	TBD	mA
Storage Temperature	$T_{STG}$	-65	150	°C
Storage Temperature under Bias	$T_{BIAS}$	-55	125	°C
Junction Temperature	$T_{JN}$	-	TBD	°C

Notes:

1. Stresses greater than those listed under ABSOLUTE MAXIMUM RATINGS may cause permanent damage to the device. This is a stress rating only and functional operation of the device at these or any other conditions above those indicated in the operational sections of this specification is not implied. Exposure to absolute maximum rating for extended periods may affect reliability.



### Recommended operating Temperature

Grade	Ambient Temperature (T <sub>A</sub> )
Commercial	0°C to 70°C
Industrial	-40°C to 85°C

### Recommended operating conditions

Parameter	Symbol	VDDQ = 2.5V <sup>[1]</sup>			VDDQ = 3.3V <sup>[2]</sup>			Unit
		Min	Typ	Max	Min	Typ	Max	
Core Supply Voltage	VDD	2.4	2.5	2.6	2.4	2.5	2.6	V
I/O supply Voltage	VDDQ	2.4	2.5	2.6	3.15	3.3	3.45	V
Ground	VSS	0	0	0	0	0	0	V

Notes:

- OPT pin for a given port must be set to VSS(0V) to operate at VDDQ = 2.5V levels on the I/Os, addresses, clock and controls of that port.
- OPT pin for a given port must be set to VDD(2.5V) to operate at VDDQ = 3.3V levels on the I/Os, addresses, clock and controls of that port.

### DC Electrical Characteristics (VDD = 2.5 V ± 100 mV)

Parameter	Symbol	VDDQ = 2.5V			VDDQ = 3.3V			Units
		Test Conditions	Min	Max	Test Conditions	Min	Max	
Input Leakage Current	I <sub>L</sub>	VDDQ = Max; 0V ≤ V <sub>IN</sub> ≤ VDDQ	-	2	VDDQ = Max; 0V ≤ V <sub>IN</sub> ≤ VDDQ	-	2	μA
PL/FT and ZZ Input Leakage Current	I <sub>L</sub>	VDD = Max; 0V ≤ V <sub>IN</sub> ≤ VDD	-	2	VDD = Max; 0V ≤ V <sub>IN</sub> ≤ VDD	-	2	μA
Output Leakage Current <sup>[1]</sup>	I <sub>LO</sub>	$\overline{OE} >= VIH$ ; 0V ≤ V <sub>OUT</sub> ≤ VDDQ	-	2	$\overline{OE} >= VIH$ ; 0V ≤ V <sub>OUT</sub> ≤ VDDQ	-	2	μA
Input high (logic 1) voltage (Address, Control, Clock & Data Inputs)	V <sub>IH</sub>	-	1.7	VDDQ + 0.1V	-	2	VDDQ + 0.15V	V
Input high voltage (ZZ, OPT, PL/FT)	V <sub>IH</sub>	-	VDD - 0.2V	VDD + 0.1V	-	VDD - 0.2V	VDD + 0.1V	V
Input low (logic 0) voltage (Address, Control, Clock & Data Inputs)	V <sub>IL</sub>	-	-0.3	0.7	-	-0.3	0.8	V
Input low voltage (ZZ, OPT, PL/FT)	V <sub>IL</sub>	-	-0.3	0.2	-	-0.3	0.2	V
Output low voltage	V <sub>OL</sub>	I <sub>OL</sub> = +2mA; VDDQ = Min	-	0.4	I <sub>OL</sub> = +4mA; VDDQ = Min	-	0.4	V
Output high voltage	V <sub>OH</sub>	I <sub>OH</sub> = -2mA; VDDQ = Min	2.0	-	I <sub>OH</sub> = -4mA; VDDQ = Min	2.4	-	V

Notes:

- Outputs disabled (High-Z condition).



**I<sub>DD</sub> operating conditions and maximum limits<sup>[4]</sup> (V<sub>DD</sub> = 2.5 V ± 100 mV)**

Parameter	Symbol	Test Conditions	-250		-200		-166		-133		Units
			Typ	Max	Typ	Max	Typ	Max	Typ	Max	
Operating current (Both ports active)	I <sub>CC</sub>	Both ports enabled ( $\overline{CE}_A = \overline{CE}_B = L^{[3]}$ ), Outputs disabled ( $I_{OUT} = 0mA$ ), $ZZ_A = ZZ_B \leq V_{IL}$ , $f=f_{Max}^{[1]}$	TBD	TBD	TBD	350	TBD	300	TBD	260	mA
Pipeline mode ( $PL/\overline{FT} \geq V_{IH}$ )			TBD	TBD	TBD	TBD	TBD	TBD	TBD	TBD	
Operating current (Both ports active)	I <sub>CC</sub>	Both ports enabled ( $\overline{CE}_A = \overline{CE}_B = L^{[3]}$ ), Outputs disabled ( $I_{OUT} = 0mA$ ), $ZZ_A = ZZ_B \leq V_{IL}$ , $f=f_{Max}^{[1]}$	TBD	TBD	TBD	TBD	TBD	TBD	TBD	TBD	mA
Flow-through mode ( $PL/\overline{FT} \leq V_{IL}$ )			TBD	TBD	TBD	TBD	TBD	TBD	TBD	TBD	
Standby current (Both ports)	I <sub>SB1</sub>	Both ports disabled ( $\overline{CE}_A = \overline{CE}_B = H$ ), $ZZ_A = ZZ_B \leq V_{IL}$ , $f=f_{Max}^{[1]}$	TBD	TBD	TBD	105	TBD	90	TBD	80	mA
Standby current (One port)	I <sub>SB2</sub>	One port enabled ( $\overline{CE}_A = L$ and $\overline{CE}_B = H$ ) <sup>[5]</sup> , Active port's outputs disabled, $ZZ_A = ZZ_B \leq V_{IL}$ , $f=f_{Max}^{[1]}$	TBD	TBD	TBD	265	TBD	225	TBD	190	mA
Full standby current (Both ports)	I <sub>SB3</sub>	Both ports disabled ( $\overline{CE}_A = \overline{CE}_B = H$ ), $ZZ_A = ZZ_B \leq V_{IL}$ , $f=0$ <sup>[2]</sup>	20	25	20	25	20	25	20	25	mA
Full standby current (One port)	I <sub>SB4</sub>	One port in Snooze ( $ZZ_A \geq V_{IH}$ , $ZZ_B \leq V_{IL}$ , and $\overline{CE}_B = L$ ) <sup>[5]</sup> , Active port's outputs disabled, $f=f_{Max}^{[1]}$	TBD	TBD	TBD	265	TBD	225	TBD	190	mA
Snooze mode current	I <sub>ZZ</sub>	Both ports in Snooze ( $ZZ_A = ZZ_B \geq V_{IH}$ ), $f=f_{Max}^{[1]}$	15	18	15	18	15	18	15	18	mA

Notes:

- $f=f_{Max}$  implies address and controls (except  $\overline{OE}$ ) are cycling at maximum clock frequency using AC test conditions (Refer AC test conditions).
- $f=0$  implies address and controls are static. Corresponding current numbers indicated are true for both CMOS ( $V_{IN} \geq V_{DDQ} - 0.2V$  or  $V_{IN} \leq 0.2V$ ) and TTL ( $V_{IN} \geq V_{IH}$  or  $V_{IN} \leq V_{IL}$ ) level inputs.
- $\overline{CE}_A$  and  $\overline{CE}_B$  are internal signals ( $\overline{CE}_x = L$  implies  $\overline{CE}0_x \leq V_{IL}$  and  $CE1_x \geq V_{IH}$ ;  $\overline{CE}_x = H$  implies  $\overline{CE}0_x \geq V_{IH}$  or  $CE1_x \leq V_{IL}$ ).
- Subscript 'x' represents 'A' for Port A and 'B' for Port B.
- "A" and "B" are interchangeable.



AC timing characteristics<sup>[1,2,5,6]</sup> (VDD = 2.5 ± 100mV)

Parameter	Symbol	-250		-200		-166		-133		Unit	Notes
		Min.	Max.	Min.	Max.	Min.	Max.	Min.	Max.		
<b>Clock</b>											
Cycle Time (Pipeline)	t <sub>CYCP</sub>	4	-	5	-	6	-	7.5	-	ns	3
Clock High Pulse Width (Pipeline)	t <sub>CHP</sub>	1.7	-	2	-	2.4	-	3	-	ns	3
Clock Low Pulse Width (Pipeline)	t <sub>CLP</sub>	1.7	-	2	-	2.4	-	3	-	ns	3
Cycle Time (Flow-Through)	t <sub>CYCF</sub>	6.5	-	7.5	-	10	-	12	-	ns	3
Clock High Pulse Width (Flow-Through)	t <sub>CHF</sub>	1.7	-	2	-	2.4	-	3	-	ns	3
Clock Low Pulse Width (Flow-Through)	t <sub>CLF</sub>	1.7	-	2	-	2.4	-	3	-	ns	3
<b>Output</b>											
Clock access time (Pipeline)	t <sub>CDP</sub>	-	2.8	-	3.4	-	3.6	-	4.2	ns	3
Output Data Hold from Clock High (Pipeline)	t <sub>OHP</sub>	1	-	1	-	1	-	1	-	ns	
Clock High to Output Low-Z (Pipeline)	t <sub>LZCP</sub>	1	-	1	-	1	-	1	-	ns	3,8
Clock High to Output High-Z (Pipeline)	t <sub>HZCP</sub>	1	2.8	1	3.4	1	3.6	1	4.2	ns	3,8
Clock access time (Flow-Through)	t <sub>CDF</sub>	-	6.5	-	7.5	-	10	-	12	ns	3
Output Data Hold from Clock High (Flow-Through)	t <sub>OHF</sub>	1	-	1	-	1	-	1	-	ns	
Clock High to Output Low-Z (Flow-Through)	t <sub>LZCF</sub>	1	-	1	-	1	-	1	-	ns	3,8
Clock High to Output High-Z (Flow-Through)	t <sub>HZCF</sub>	1	2.8	1	3.4	1	3.6	1	4.2	ns	3,8
Output Enable to Data Valid	t <sub>OE</sub>	-	2.8	-	3.4	-	3.6	-	4.2	ns	4
Output Enable Low to Output Low-Z	t <sub>LZOE</sub>	1	-	1	-	1	-	1	-	ns	4
Output Enable High to Output High-Z	t <sub>HZOE</sub>	1	2.8	1	3.4	1	3.6	1	4.2	ns	4
<b>Setup</b>											
Address Setup to Clock High	t <sub>AS</sub>	1.2	-	1.5	-	1.7	-	1.8	-	ns	
Chip Enable Setup to Clock High	t <sub>CES</sub>	1.2	-	1.5	-	1.7	-	1.8	-	ns	
Byte Enable Setup to Clock High	t <sub>BS</sub>	1.2	-	1.5	-	1.7	-	1.8	-	ns	
R/W Setup to Clock High	t <sub>WS</sub>	1.2	-	1.5	-	1.7	-	1.8	-	ns	
Input Data Setup to Clock High	t <sub>DS</sub>	1.2	-	1.5	-	1.7	-	1.8	-	ns	
AD <sub>S</sub> Setup to Clock High	t <sub>ADSS</sub>	1.2	-	1.5	-	1.7	-	1.8	-	ns	
IN <sub>C</sub> Setup to Clock High	t <sub>INCS</sub>	1.2	-	1.5	-	1.7	-	1.8	-	ns	
RPT Setup to Clock High	t <sub>RPTS</sub>	1.2	-	1.5	-	1.7	-	1.8	-	ns	
<b>Hold</b>											
Address Hold from Clock High	t <sub>AH</sub>	0.3	-	0.5	-	0.5	-	0.5	-	ns	
Chip Enable Hold from Clock High	t <sub>CEH</sub>	0.3	-	0.5	-	0.5	-	0.5	-	ns	
Byte Enable Hold from Clock High	t <sub>BH</sub>	0.3	-	0.5	-	0.5	-	0.5	-	ns	
R/W Hold from Clock High	t <sub>WH</sub>	0.3	-	0.5	-	0.5	-	0.5	-	ns	
Input Data Hold from Clock High	t <sub>DH</sub>	0.3	-	0.5	-	0.5	-	0.5	-	ns	
AD <sub>S</sub> Hold from Clock High	t <sub>ADSH</sub>	0.3	-	0.5	-	0.5	-	0.5	-	ns	
IN <sub>C</sub> Hold from Clock High	t <sub>INCH</sub>	0.3	-	0.5	-	0.5	-	0.5	-	ns	
RPT Hold from Clock High	t <sub>RPTH</sub>	0.3	-	0.5	-	0.5	-	0.5	-	ns	
<b>Flag</b>											
Interrupt Flag Set Time	t <sub>SINT</sub>	-	6	-	6	-	6	-	7	ns	
Interrupt Flag Reset Time	t <sub>RINT</sub>	-	6	-	6	-	6	-	7	ns	
Collision Flag Set Time	t <sub>SCOL</sub>	-	2.8	-	3.4	-	3.6	-	4.2	ns	
Collision Flag Reset Time	t <sub>RCOL</sub>	-	2.8	-	3.4	-	3.6	-	4.2	ns	
<b>Port-to-Port Delay</b>											
Clock-to-Clock Delay	t <sub>CCO</sub>	3.0	-	3.5	-	4	-	5	-	ns	7

Notes:

- All timings are same for both ports.
- These values are valid for either level of VDDQ (2.5V/3.3V)
- A particular port will operate in Pipeline output mode if PL/FT = VDD and in flow-through output mode if PL/FT = 0V. Each port can independently operate in any of these modes.
- Output Enable ( $\overline{OE}$ ) is an asynchronous input.
- PL/FT and OPT should be treated as DC signals and should reach steady state before normal operation.
- Refer AC Test Conditions to view the test conditions used for these measurements.
- This parameter has to be taken care to avoid collision during simultaneous memory access of the same location.
- To avoid bus contention, at a given voltage and temperature t<sub>LZC</sub> is more than t<sub>HZC</sub> (True in both Pipeline and flow-through output mode).



### Timing waveform of read cycle<sup>[7]</sup>

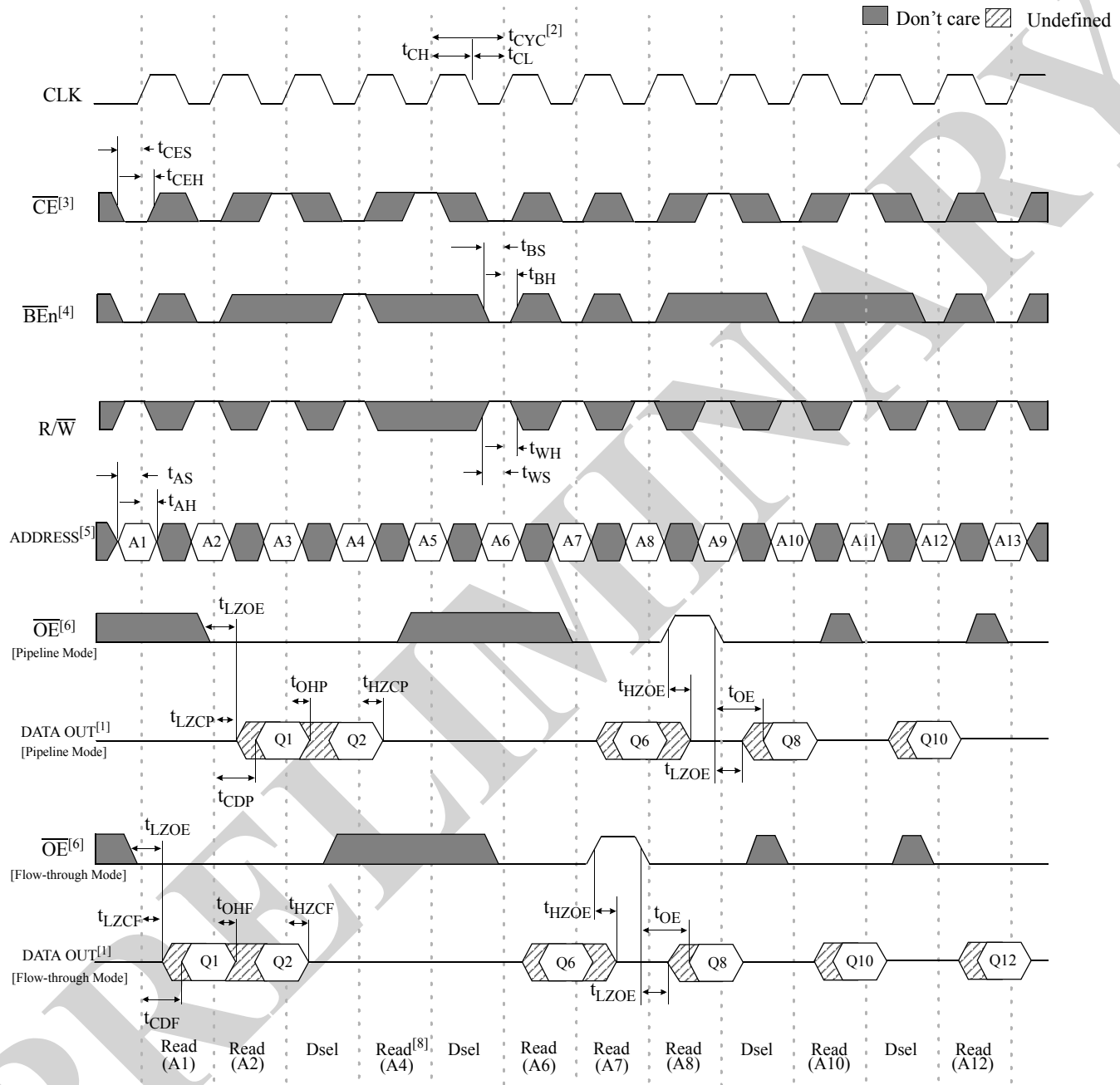

- Notes:
- Both Flow-through and Pipeline Outputs indicated. A particular port is configured in Flow-through mode if  $PL/\overline{FT}$  for that port is driven low, and in Pipeline mode if  $PL/\overline{FT}$  is driven high or left unconnected.
  - Parameters  $t_{CYC}$ ,  $t_{CH}$  and  $t_{CL}$  are different in Flow-through and Pipeline modes of operation (Refer AC Timing characteristics).
  - $\overline{CE}$  is an internal signal.  $\overline{CE} = H$  implies 'Chip is Deselected' ( $CE0 = H$  or  $CE1 = L$ ),  $\overline{CE} = L$  implies 'Chip is Selected' ( $CE0 = L$  and  $CE1 = H$ ). Timings indicated for  $\overline{CE}$  hold good for  $CE0$  and  $CE1$ .
  - $\overline{BEn}$  refers to any one of the 4 byte controls [ $n = 3, 2, 1$  or 0] and DATA OUT refers to the corresponding Byte.
  - Counter set in "Load" mode ( $ADS = L, INC = X, RPT = H$ ).
  - $\overline{OE}$  is an asynchronous input.
  - All timings are similar for both ports.
  - Read with Byte disabled. Data is not read out. Bus in High-Z condition.



### Timing wave form read/write cycle<sup>[7]</sup>

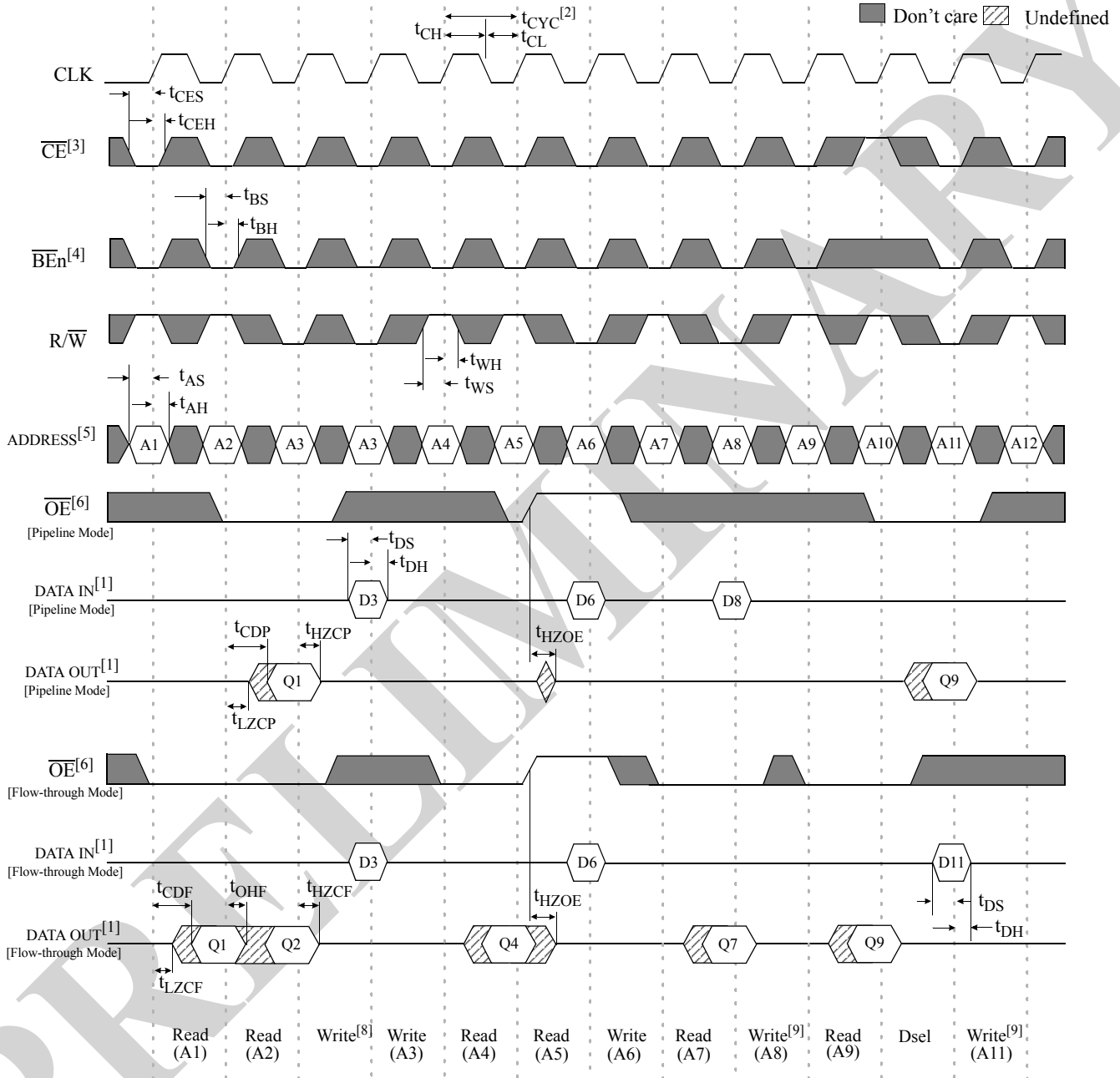

Notes:

- Both Flow-through and Pipeline Inputs/Outputs indicated. A particular port is configured in Flow-through mode if PL/FT for that port is driven low, and in Pipeline mode if PL/FT is driven high or left unconnected.
- Parameters  $t_{CYC}$ ,  $t_{CH}$  and  $t_{CL}$  are different in Flow-through and Pipeline modes of operation. (Refer AC Timing characteristics)
- $\overline{CE}$  is an internal signal.  $\overline{CE} = H$  implies 'Chip is Deselected' ( $\overline{CE0} = H$  or  $CE1 = L$ ),  $\overline{CE} = L$  implies 'Chip is Selected' ( $\overline{CE0} = L$  and  $CE1 = H$ ). Timings indicated for  $\overline{CE}$  hold good for  $\overline{CE0}$  and  $CE1$
- $\overline{BE}_n$  refers to any one of the 4 byte controls [ $n = 3, 2, 1$  or  $0$ ] and DATA OUT refers to the corresponding Byte.
- Counter set in "Load" mode ( $ADS = L, INC = X, RPT = H$ ).
- $\overline{OE}$  is an asynchronous input.
- All timings are similar for both ports.
- Invalid write. Memory Content of the selected location may get corrupted and should be re-written before future readback.
- Write (A11) is invalid in Pipeline mode and Write (A8) is invalid in Flow-through mode. Memory Content of the selected location may get corrupted and should be re-written before future readback.



### Timing waveform of address counter<sup>[6]</sup>

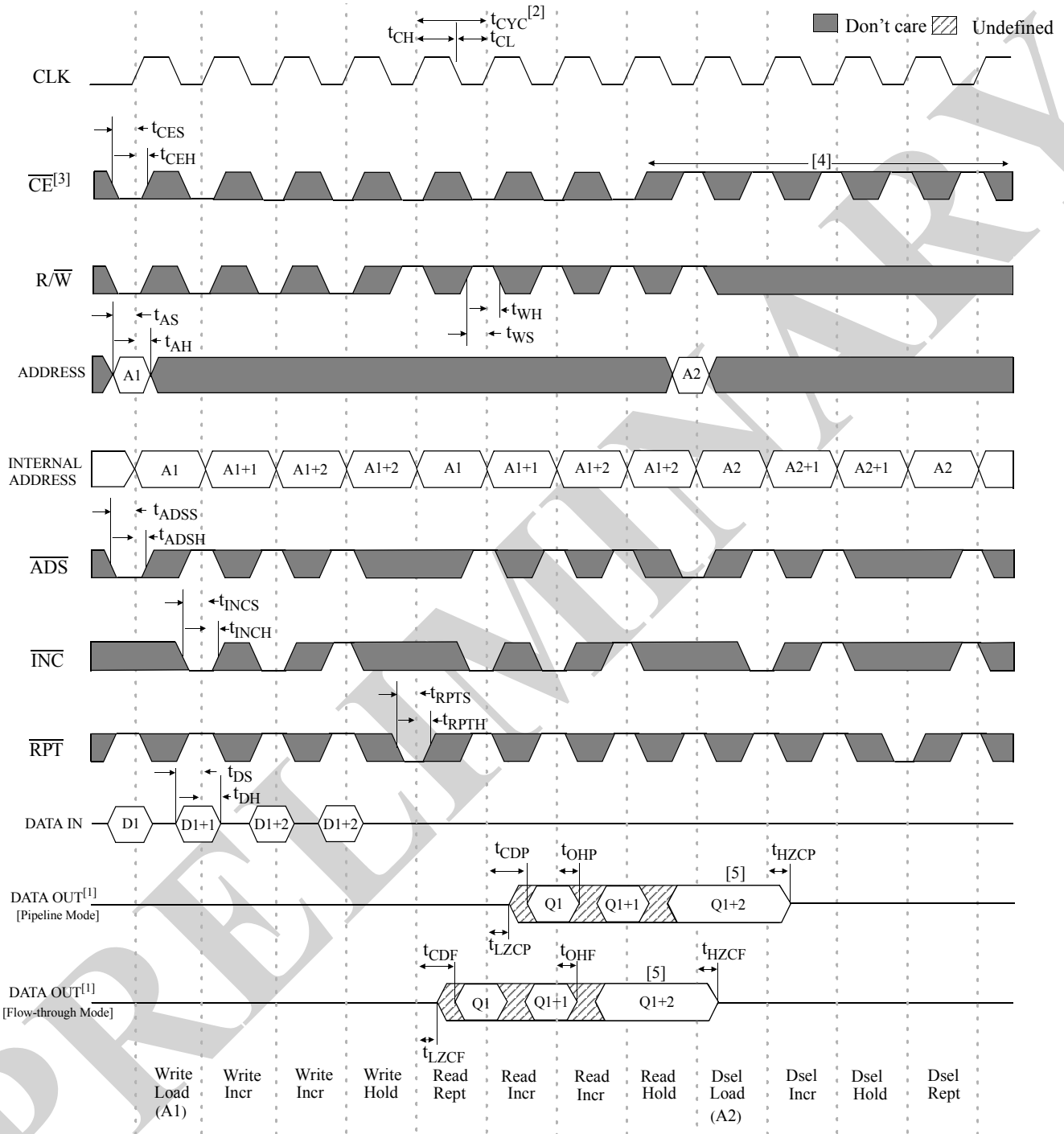

Notes:

- Both Flow-through and Pipeline Outputs indicated. A particular port is configured in Flow-through mode if PL/FT for that port is driven low, and in Pipeline mode if PL/FT is driven high or left unconnected.
- Parameters  $t_{CYC}$ ,  $t_{CH}$  and  $t_{CL}$  are different in Flow-through and Pipeline modes of operation (Refer AC Timing characteristics).
- $\overline{CE}$  is an internal signal.  $\overline{CE} = H$  implies 'Chip is Deselected' ( $CE0 = H$  or  $CE1 = L$ ),  $\overline{CE} = L$  implies 'Chip is Selected' ( $CE0 = L$  and  $CE1 = H$ ). Timings indicated for  $\overline{CE}$  hold good for  $CE0$  and  $CE1$ .
- These cycles indicate that Counter works independent of all memory controls including  $R/\overline{W}$ ,  $\overline{CE}$  and  $\overline{BEn}$ .
- If a Hold operation is performed for a Read access, the Data-out is held valid for the subsequent clock cycle also.
- All timings are similar for both ports.



## Mailbox Interrupts

The AS9C25256M2036L/AS9C25128M2036L has an Inbuilt Mailbox Logic that can be used for communication between the two ports. One memory location is assigned as mail box (message center) for each port. The location 3FFFE (HEX) is assigned as the message center for Port A and 3FFFF (HEX) for Port B (IFFFE and IFFFF for AS9C25128M2036L). The port A interrupt flag ( $\overline{INT}_A$ ) is asserted when the port B writes to memory location 3FFFE (HEX) (IFFFE for AS9C25128M2036L). The port A clears the interrupt flag by reading the address location 3FFFE (HEX) (IFFFE for AS9C25128M2036L). Likewise, the port B interrupt flag ( $\overline{INT}_B$ ) is asserted when the port A writes to memory location 3FFFF (HEX) (IFFFF for AS9C25128M2036L) and to clear the interrupt flag ( $\overline{INT}_B$ ), the port B must read the memory location 3FFFF (IFFFF for AS9C25128M2036L) (Refer Interrupt Logic Truth Table).

The interrupt flag is asserted in a flow-through mode (i.e., it follows the clock edge of the writing port). Also, the flag is reset in a flow-through mode (i.e., it follows the clock edge of the reading port). Each port can read the other port's mailbox without de-asserting the interrupt and each port can write to its own mailbox without asserting the interrupt. If an application does not require message passing,  $\overline{INT}$  pins can be ignored.

### Interrupt logic truth table<sup>[1,4]</sup>

$CLK_A$	$R/\overline{W}_A$	$\overline{CE}_A$ <sup>[2]</sup>	$A17_A-A0_A$ <sup>[3,5]</sup>	$CLK_B$	$R/\overline{W}_B$	$\overline{CE}_B$ <sup>[2]</sup>	$A17_B-A0_B$ <sup>[3,5]</sup>	$\overline{INT}_A$	$\overline{INT}_B$	Function
L to H	L	L	3FFFF	L to H	X	X	X	X	L	Assert Port B Interrupt Flag
L to H	X	X	X	L to H	H	L	3FFFF	X	H	De-assert Port B Interrupt Flag
L to H	X	X	X	L to H	L	L	3FFFE	L	X	Assert Port A Interrupt Flag
L to H	H	L	3FFFE	L to H	X	X	X	H	X	De-assert Port A Interrupt Flag

Notes:

1. L = low, H = high, X = don't care

2.  $\overline{CE}_x$  is an internal signal ('x' = 'A' or 'B').  $\overline{CE}_x = H$  implies 'Chip is Deselected' ( $\overline{CE0}_x = H$  or  $CE1_x = L$ ),  $\overline{CE}_x = L$  implies 'Chip is Selected' ( $\overline{CE0}_x = L$  and  $CE1_x = H$ )

3. Address specified here is the internal address (refer Counter control truth table).

4. Both Interrupt Flags are De-asserted on power-up.

5. Address A17 is a NC for AS9C25128M2036L, hence Interrupt addresses are IFFFF and IFFFE





Interrupt timing wave form<sup>[2]</sup>

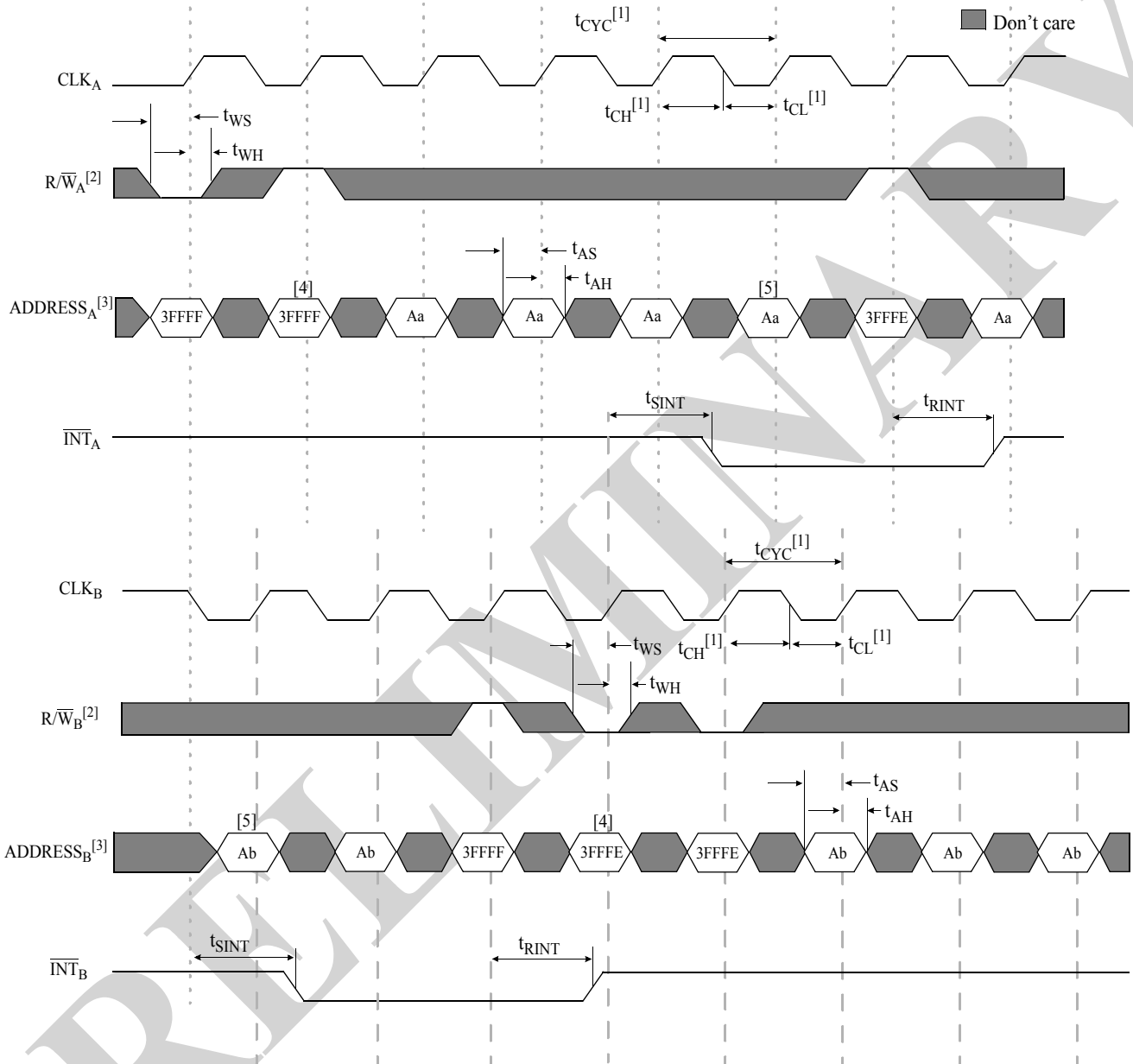

Notes:

1. Parameters  $t_{CYC}$ ,  $t_{CH}$  and  $t_{CL}$  are different in Flow-through and Pipeline mode of operation and can be different for different ports (Refer AC Timing characteristics).
2. Chip Selected ( $CE0 = L$  and  $CE1 = H$ ). True for both ports.
3. Address indicated is the Internal Address used and is dependent on the Address counter control inputs for that cycle.
4. 3FFFF (IFFFF for AS9C25128M2036L) is the Mailbox for port B and 3FFFE (IFFFE for AS9C25128M2036L) is the Mailbox for port A.
5. "Aa" and "Ab" refer to any other valid address other than 3FFFF or 3FFFE (IFFFF or IFFFE for AS9C25128M2036L).



## Collision detection

Three different cases of collisions can be listed depending on the type of access from two ports:

**Simultaneous Read:** A true dual-ported memory cell allows data to be read simultaneously from both ports of the device. Hence no data is corrupted, lost, or incorrectly output, and none of the collision alert flags is asserted.

**Simultaneous Write:** When both ports are writing simultaneously to the same location, both write operations would fail. Therefore, the collision flag is asserted on both ports.

**Simultaneous Read and Write:** When one port is writing and the other port is reading from the same location in the memory, the data written will be valid. However, the read operation would fail and hence the reading port's collision flag is asserted.

The alert flag ( $\overline{COL}_x$ ) is asserted on the 3rd (for both pipe-lined and flow-through output mode) rising clock edge of the affected port following the collision, and remains low for one cycle. On continuous collisions (one or both ports writing during each access), the collision alert flag will be asserted and de-asserted every alternate cycle.

### Collision detection truth table<sup>[1,2,4]</sup>

CLK <sub>A</sub>	R/ $\overline{W}$ <sub>A</sub>	CLK <sub>B</sub>	R/ $\overline{W}$ <sub>B</sub>	Port address <sup>[3]</sup>	$\overline{COL}_A$	$\overline{COL}_B$	Function
L to H	H	L to H	H	MATCH	H	H	Both ports reading. Not a valid collision. No collision flag asserted on either port.
L to H	H	L to H	L	MATCH	L	H	Port A reading, Port B writing. Valid collision. Collision flag asserted on port A.
L to H	L	L to H	H	MATCH	H	L	Port B reading, Port A writing. Valid collision. Collision flag asserted on port B.
L to H	L	L to H	L	MATCH	L	L	Both ports writing. Valid collision. Collision flag asserted on both ports.
L to H	L	L to H	H	NO MATCH	H	H	No match. No collision flag asserted on either port.

Notes:

1. L = low, H = high, X = don't care
2. Chip Selected ( $\overline{CE0} = L$  and  $\overline{CE1} = H$ ). True for both ports. Collision flag is not affected if any one or both ports are deselected.
3. "MATCH" indicates that internal addresses of both the ports are the same (refer Counter control truth table).
4. Both Collision Flags are De-asserted on power-up.



Collision timing waveform<sup>[2]</sup>

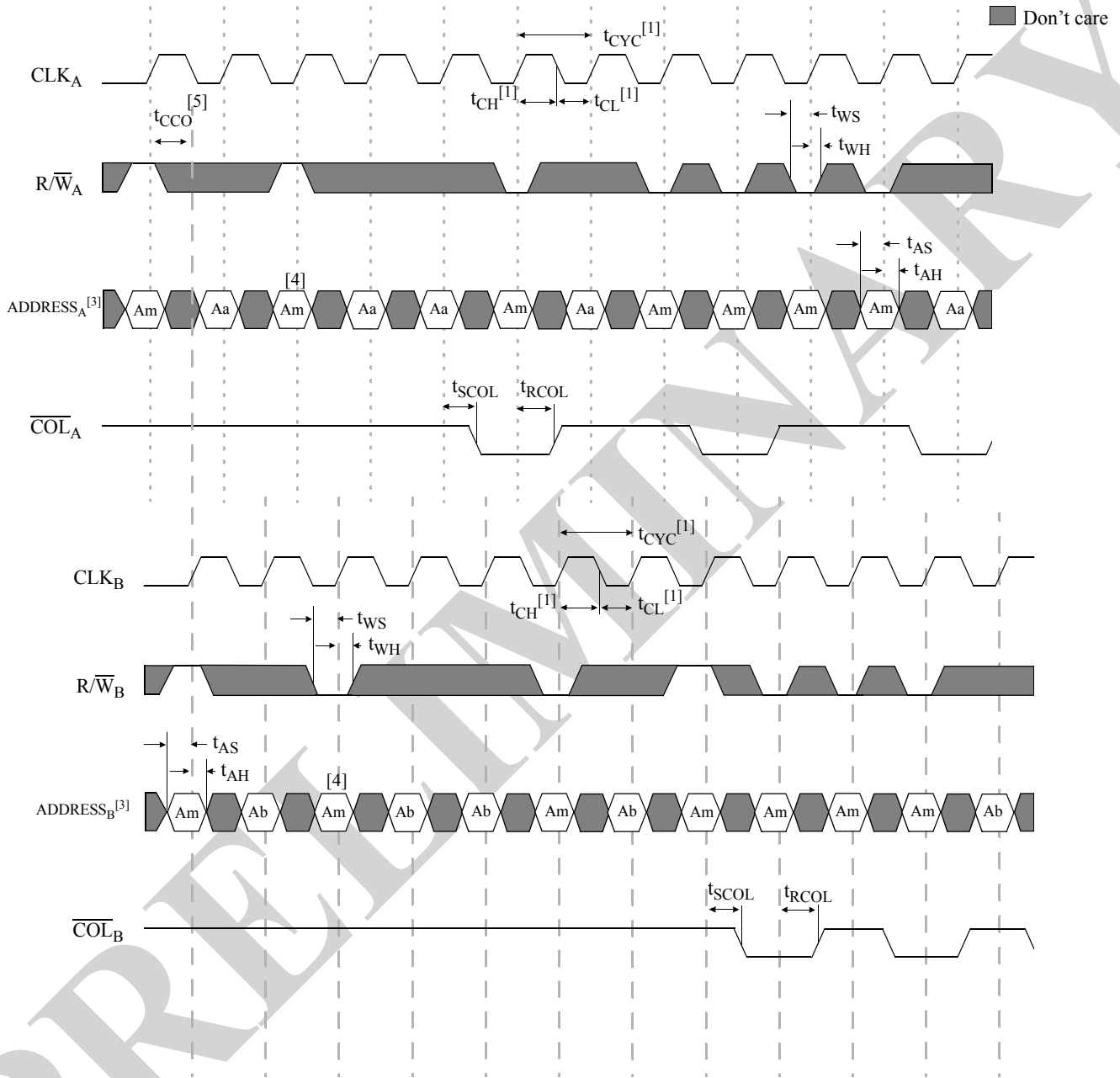

Notes:

- Parameters  $t_{CYC}$ ,  $t_{CH}$  and  $t_{CL}$  are different in Flow-through and Pipeline mode of operation and can be different for different ports (Refer AC Timing characteristics).
- Chip Selected ( $\overline{CE0} = L$  and  $CE1 = H$ ). True for both ports.
- Address indicated is the Internal Address used and is dependent on the Address counter control inputs for that cycle.
- "Am" refers to matched address. "Aa" and "Ab" refer to any other valid address.
- During address collision the data validity is guaranteed only if  $t_{CCO}$  is greater than the minimum specified (Refer AC timing characteristics).



## Depth and Width expansion

AS9C25256M2036L/AS9C25128M2036L has two chipselects (one active high and other active low) for simple depth expansion. This permits easy upgrade from 256/128K depth to 512K/256K depth without extra logic. Two such parts can also be combined to obtain an expanded width of 72 bits or wider.

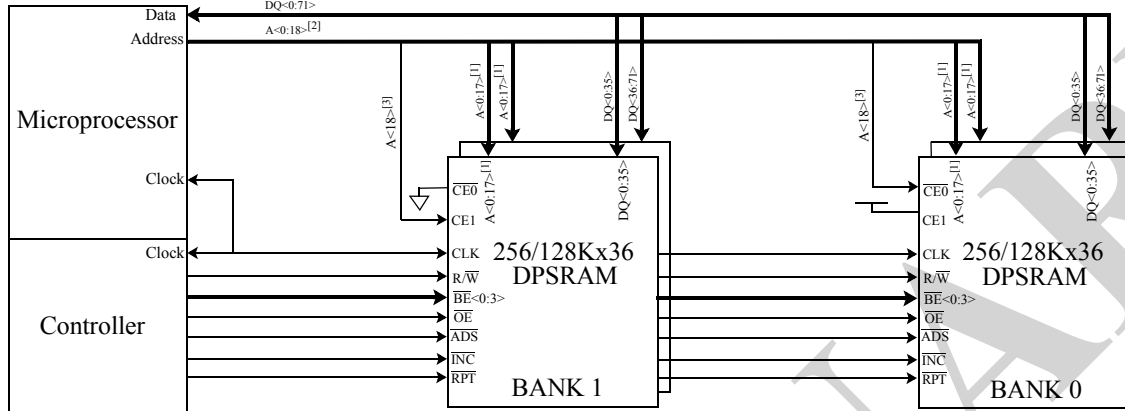

Notes:

1. A<0:17> for AS9C25256M2036L, A<0:16> for AS9C25128M2036L
2. A<0:18> for AS9C25256M2036L, A<0:17> for AS9C25128M2036L
3. A<18> for AS9C25256M2036L, A<17> for AS9C25128M2036L

## Timing waveform of multi device read<sup>[4,5,6]</sup>

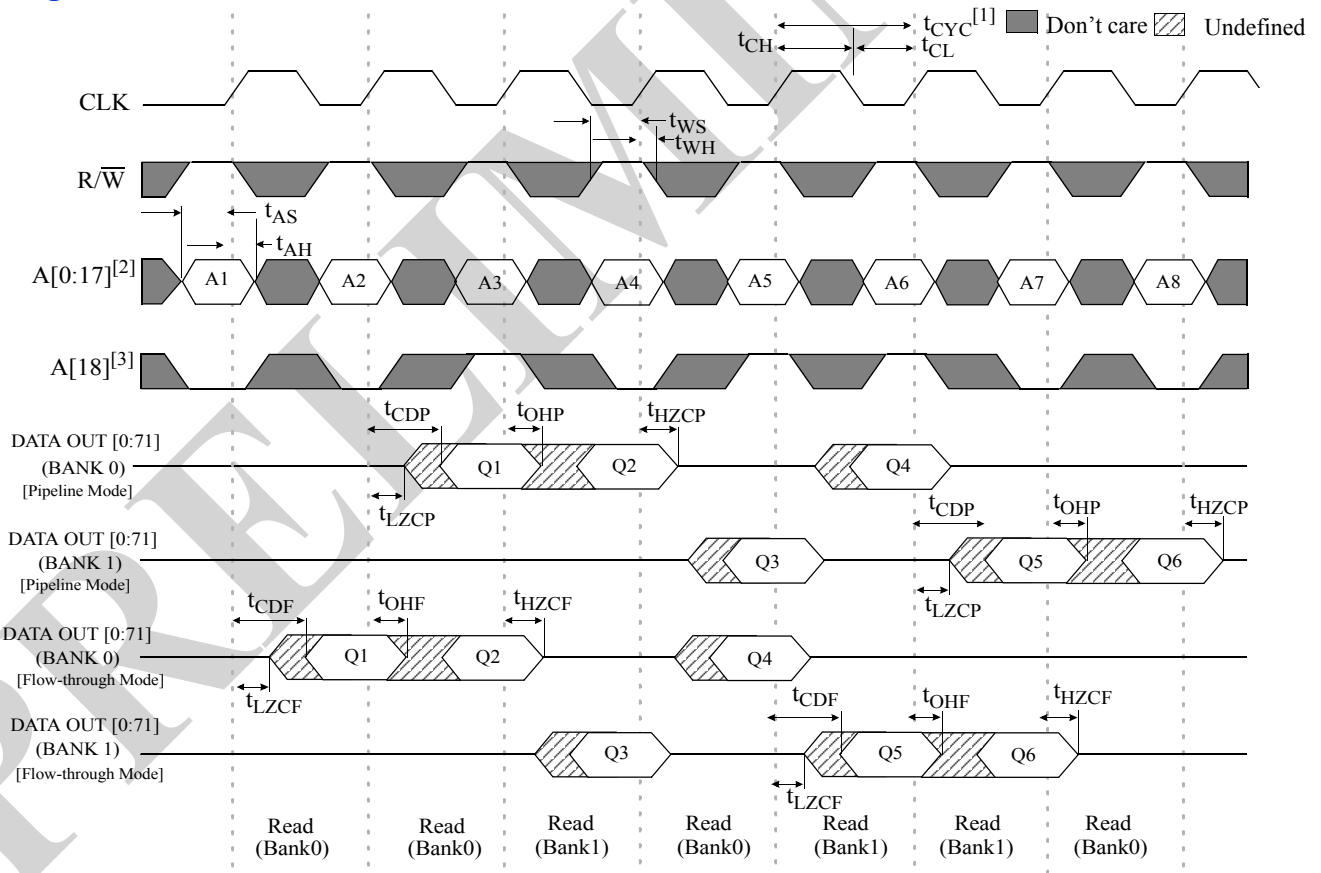

Notes:

1. Parameters  $t_{CYC}$ ,  $t_{CH}$  and  $t_{CL}$  are different in Flow-through and Pipeline mode of operation (Refer AC Timing characteristics).
2. A<0:17> for AS9C25256M2036L, A<0:16> for AS9C25128M2036L
3. A<18> for AS9C25256M2036L, A<17> for AS9C25128M2036L
4. Refer to the above block diagram for the assumed setup.
5. One Bank is assumed to have two AS9C25256M2036L/AS9C25128M2036Ls combined to have an expanded width of 72 bits. Two such Banks are used for depth expansion.
6. All  $\overline{BEN}$ 's = L, Counter set in "Load" mode (ADS = L, INC = X, RPT = H), OE = L.



## Snooze mode

Snooze mode is a low-current, power-down mode in which the corresponding port is deselected and its current is reduced to a very low value. Both ports are equipped with independent SNOOZE inputs (ZZ). During Snooze mode, all inputs of the port except ZZ are internally disabled and all its Outputs go to High-Z.

ZZ is an asynchronous, active HIGH input that causes the selected port to enter Snooze mode. If both ports go into Snooze mode, the device is deselected and current is reduced to  $I_{ZZ}$ . When  $ZZ_A$  and  $ZZ_B$  become a logic HIGH,  $I_{ZZ}$  is guaranteed after the setup time  $t_{SCZZ}$  is met.

Any READ or WRITE operation pending when the port enters Snooze mode is not guaranteed to complete. Therefore, Snooze mode must not be initiated until valid pending operations are completed. Similarly during the time  $t_{RCZZ}$ , when the port is transitioning out of snooze mode, only DESELECT cycles should be given.

## Snooze mode electrical characteristics

Description	Conditions	Symbol	Min	Max	Units
SNOOZE MODE Current	$ZZ_A = ZZ_B \geq V_{IH}$	$I_{ZZ}$	15	18	mA
ZZ active to input ignored		$t_{SCZZ}$	-	2	cycle
ZZ inactive to input sampled		$t_{RCZZ}$	2	-	cycle
ZZ active to enter Snooze Current		$t_{SIZZ}$	-	2	cycle
ZZ inactive to exit Snooze Current		$t_{RIZZ}$	0	-	cycle

## Snooze mode timing waveform<sup>[1,3]</sup>

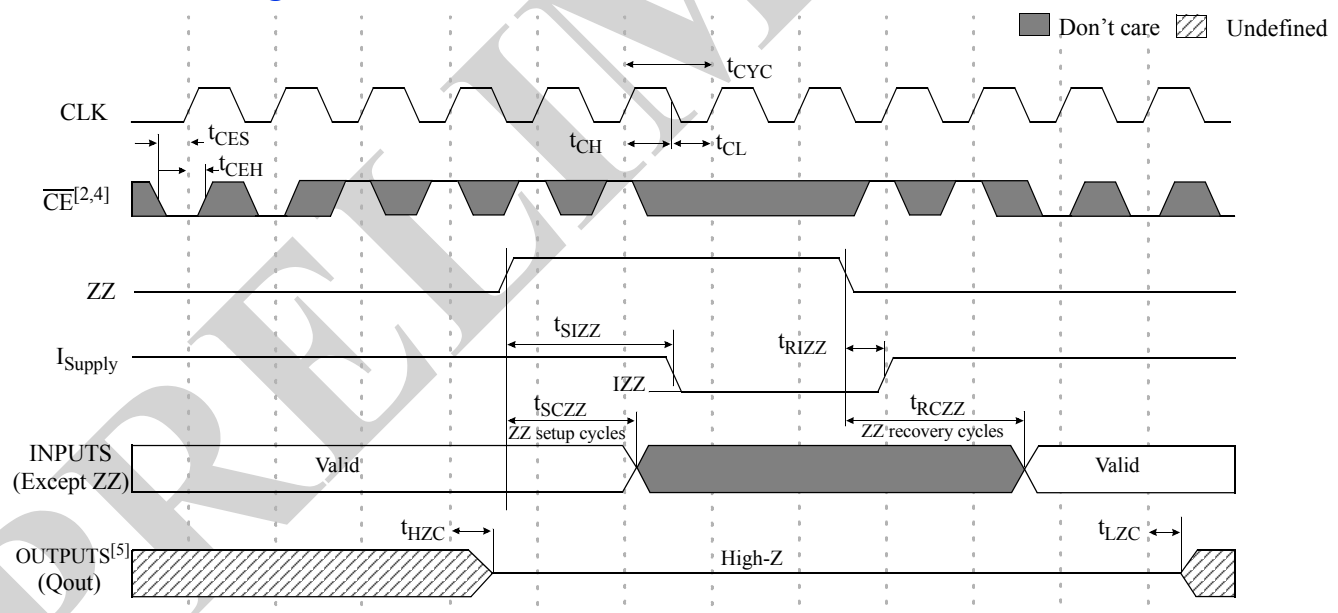

Notes:

1. During Snooze mode, all dynamic inputs are disabled (except JTAG inputs). During JTAG operations,  $ZZ_x$  must be held Low in order to capture the parallel inputs of the boundary scan register. All static inputs (i.e. PL/FT<sub>x</sub>, OPT<sub>x</sub>) and  $ZZ_x$  themselves are not affected during snooze mode.
2.  $\overline{CE}$  is an internal signal.  $\overline{CE} = H$  implies 'Chip is Deselected' ( $\overline{CE0} = H$  or  $CE1 = L$ ),  $\overline{CE} = L$  implies 'Chip is Selected' ( $\overline{CE0} = L$  and  $CE1 = H$ ).
3. All timings are same for Port A and Port B.
4. Minimum of two deselect cycles should be given before asserting snooze and minimum of two deselect cycles should be given after de-asserting snooze to guarantee data integrity.
5. Select cycles indicated before and after Snooze are Read cycles. They can also be Write cycles.



**AC test conditions**

Input Pulse Level (Address and Controls)	GND to 3.0V/GND to 2.4V
Input Pulse Levels (I/Os)	GND to 3.0V/GND to 2.4V
Input Rise/Fall Times	2V/ns
Input Timing Reference Levels	1.5V/1.25V
Output Reference levels	1.5V/1.25V
Output Load (for $t_{LZC}$ , $t_{HZC}$ , $t_{LZOE}$ , $t_{HZOE}$ )	Fig. C
Output Load (for all other measurements)	Fig. B

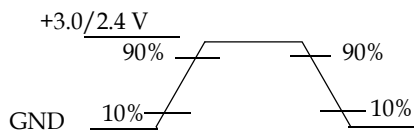

Figure A: Input Waveform

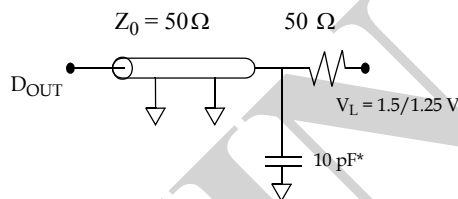

Figure B: Output Load (A)

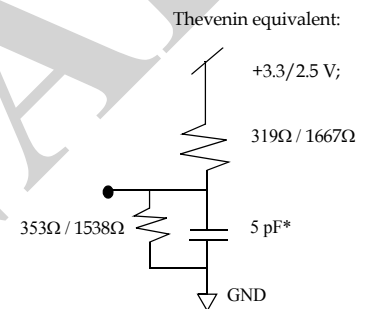

Figure C: Output Load (B)

\* Including scope and jig capacitance



### IEEE 1149.1 Serial boundary scan (JTAG)

The SRAM incorporates a serial boundary scan Test Access Port (TAP). All JTAG pins operate using JEDEC standard 2.5V I/O logic levels. In order to operate the device without using the JTAG feature, all JTAG pins may be left unconnected. On power-up, the device will start in a reset state which will not interfere with normal device operation.

### TAP Controller block diagram

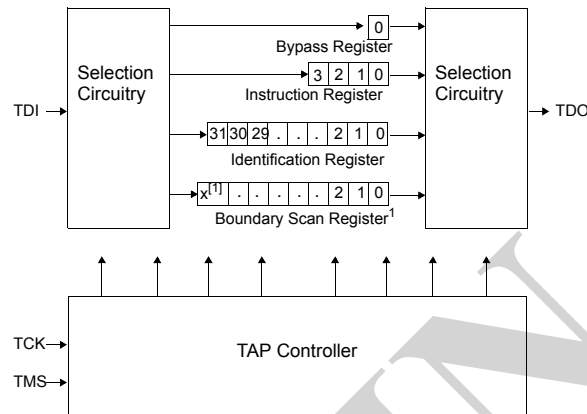

Note:  
1. x = 149

### JTAG timing waveform

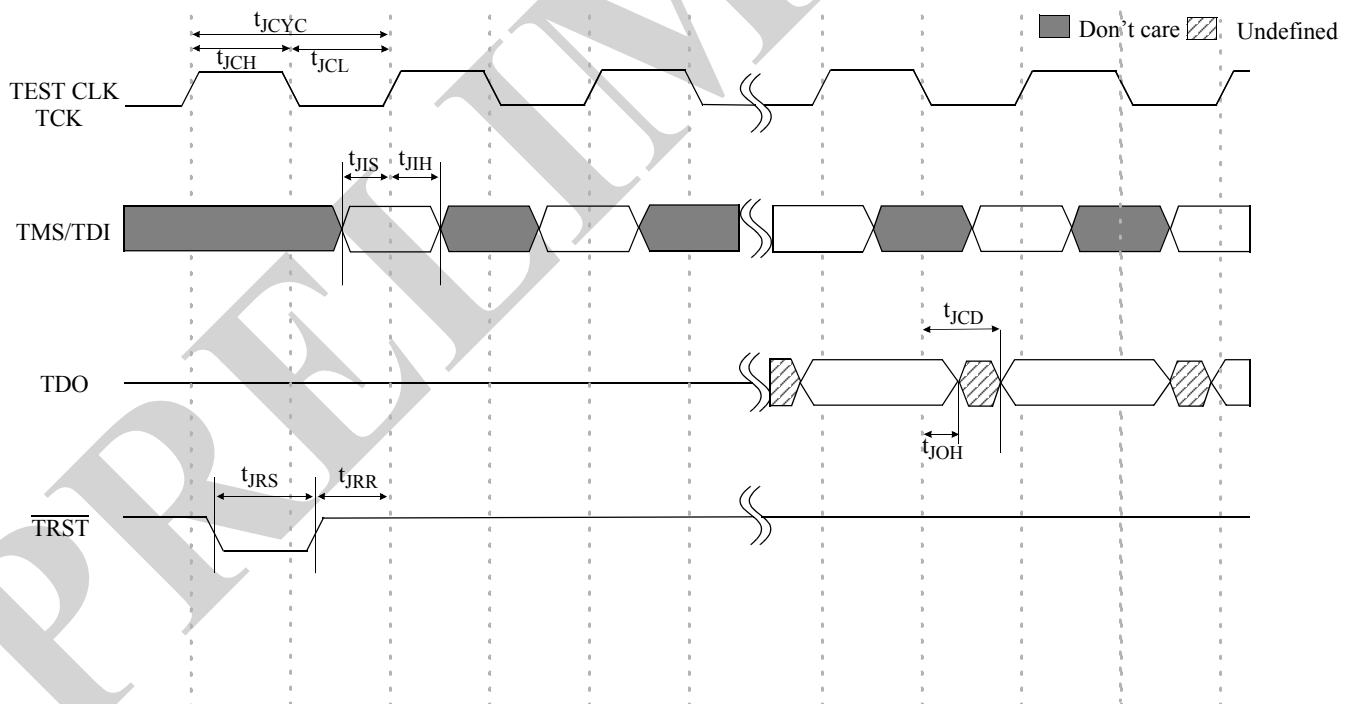



## TAP AC electrical characteristics<sup>[2]</sup>

Description	Symbol	Min	Max	Units
<b>Clock</b>				
Clock cycle time	$t_{JCYC}$	100	-	ns
Clock frequency	$f_{JTAG}$	-	10	MHz
Clock high time	$t_{JCH}$	40	-	ns
Clock low time	$t_{JCL}$	40	-	ns
<b>Output Times</b>				
TCK low to TDO unknown	$t_{JOH}$	0	-	ns
TCK low to TDO valid	$t_{JCD}$	-	20	ns
<b>Setup Times</b>				
TMS/TDI setup	$t_{JIS}$	10	-	ns
Capture setup	$t_{JCS}^{[1]}$	10	-	ns
<b>Hold Times</b>				
TMS/TDI hold	$t_{JIH}$	10	-	ns
Capture hold	$t_{JCH}^{[1]}$	10	-	ns
<b>Reset Times</b>				
JTAG Reset	$t_{JRS}$	50	-	ns
JTAG Reset Recovery	$t_{JRR}$	50	-	ns

Notes:

- $t_{JCS}$  and  $t_{JCH}$  refer to the setup and hold time requirements of latching data from the boundary scan register.
- Test conditions are specified using the load in the figure TAP AC output load equivalent.

## TAP AC test conditions & output load equivalent

Input pulse levels	V <sub>SS</sub> to 2.5V
Input rise and fall times	1V/ns
Input timing reference levels	1.25V
Output reference levels	1.25V
Test load termination supply voltage	1.25V

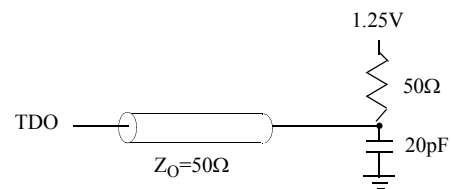

## TAP DC electrical characteristics and operating conditions (VDD=2.5V ± 100 mV)

Description	Symbol	Conditions	Min	Max	Units
Input high (logic 1) voltage	V <sub>IH</sub>		1.7	VDD + 0.3	V
Input low (logic 0) voltage	V <sub>IL</sub>		-0.3	0.7	V
Input leakage current	I <sub>LI</sub>	VDD = Max; 0V < V <sub>IN</sub> < VDD	0	10	μA
Output leakage current	I <sub>LO</sub>	Outputs disabled, 0V < V <sub>OUT</sub> < VDDQ (DQ <sub>x</sub> )	0	10	μA
Output low voltage	V <sub>OLC</sub>	I <sub>OLC</sub> = 100μA		0.2	V
Output low voltage	V <sub>OLT</sub>	I <sub>OLT</sub> = 2mA		0.7	V
Output high voltage	V <sub>OHC</sub>	I <sub>OHC</sub> = -100μA	2.1		V
Output high voltage	V <sub>OHT</sub>	I <sub>OHT</sub> = -2mA	1.7		V





### Identification register definitions

Instruction field	Value	Description
Revision number (31:28)	TBD	Version Number
Device depth (27:12)	TBD	ALSC part number
JEDEC ID code (11:1)	00001010010	Manufacturer Identity Code (ALSC)
Indicator Bit (0)	1	ID Register presence indicator

### Scan register sizes

Register name	Bit size
Instruction Register (IR)	4
Bypass Register (BYR)	1
Identification Register (IDR)	32
Boundary Scan Register (BSR)	150

### Instruction codes

Instruction	Code	Description	Selected Reg
EXTEST	0000	Forces contents of the BSR onto the device outputs.	BSR
SAMPLE/PRELOAD	0001	Samples the I/O ring contents. Preloads test data into the BSR.	BSR
IDCODE	0010	Loads the IDR with the vendor ID code and places the register between TDI and TDO.	IDR
CLAMP	0011	Forces contents of the BSR onto the device outputs.	BYR
HIGHZ	0100	Forces all device 2-state and 3-state outputs to High-Z.	BYR
RESERVED	0101 - 1110	Reserved states. Do not use.	BYR
BYPASS	1111	Places the BYR between TDI and TDO.	BYR



Package Diagram: 256-ball Ball Grid Array (BGA)

All measurements are in mm.			
	Min	Typ	Max
A		1.00	
B	16.95	17.00	17.05
C		15.00	
D	16.95	17.00	17.05
E		15.00	
F		0.36	
G	0.35		0.50
H			1.60
I	0.40	0.50	0.60
J		0.70	

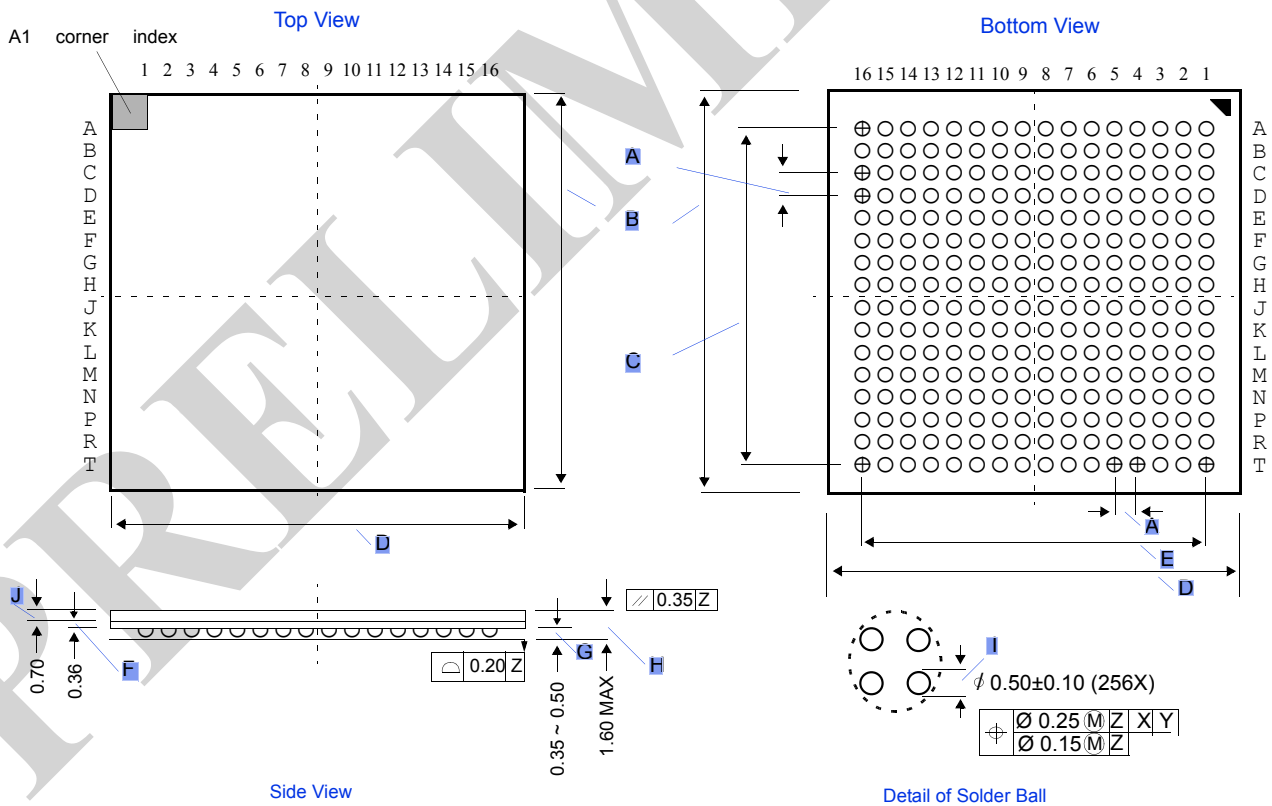



Package Diagram: 208-ball fine pitch Ball Grid Array (fpBGA)

All measurements are in mm.			
	Min	Typ	Max
A		0.80	
B	14.95	15.00	15.05
C		12.80	
D	14.95	15.00	15.05
E		12.80	
F		0.26	
G	0.25		0.40
H			1.40
I	0.40	0.45	0.50
J		0.70	

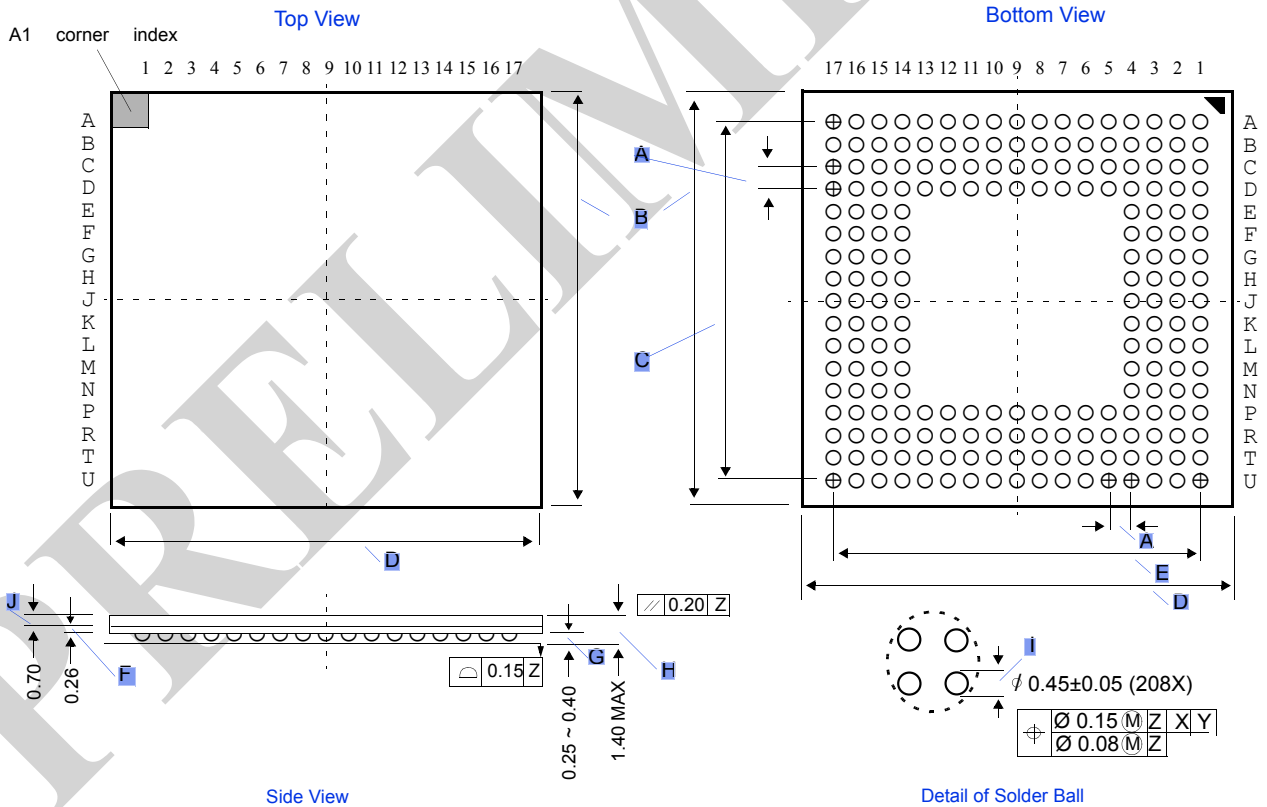



Package Diagram: 208-pin Plastic Quad Flat Pack (PQFP)

	PQFP		
	Min	Typ	Max
A1	0.25		
A2	3.20	3.32	3.60
b	0.17	0.20	0.27
c	0.11	0.15	0.23
D	28.00 nominal		
E	28.00 nominal		
e	0.50 nominal		
Hd	31.20 nominal		
He	31.20 nominal		
L	0.73	0.88	1.03
L1	1.60 nominal		
$\alpha$	0°		7°
Dimensions in millimeters			

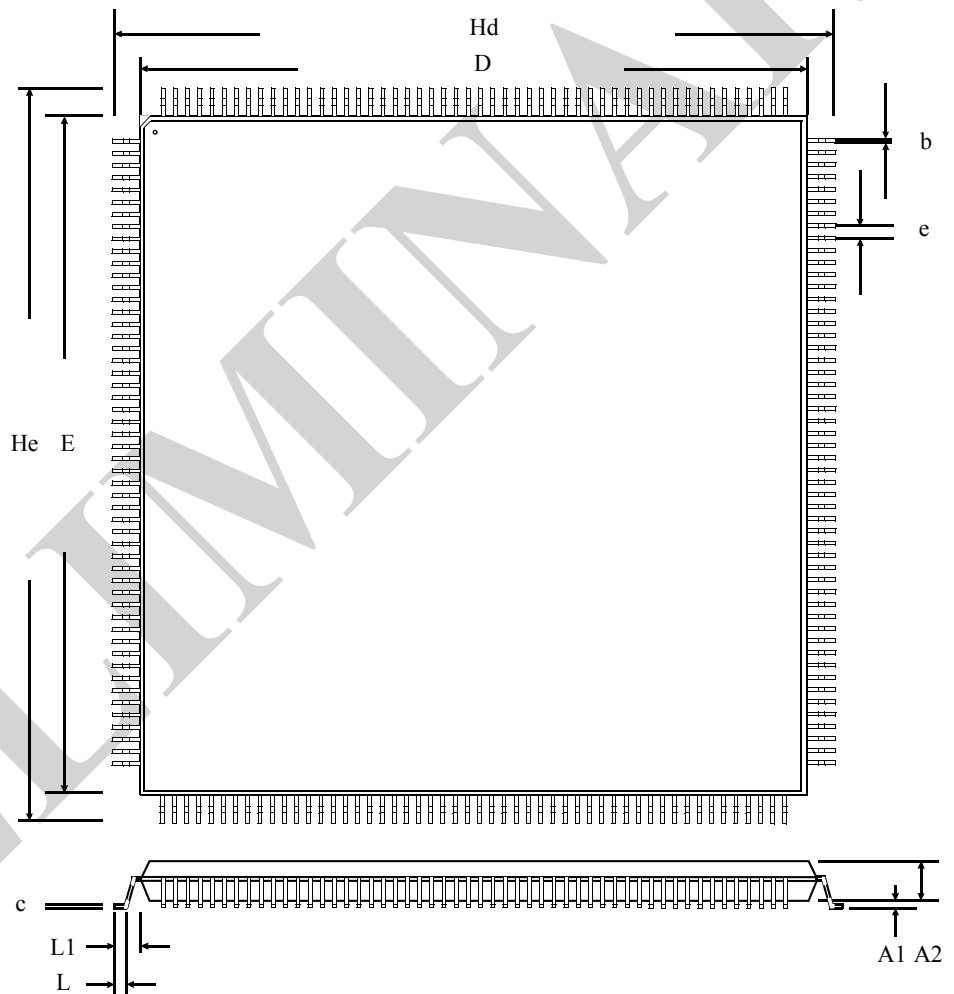



## Ordering Information

Package & Width	-250	-200	-166	-133
<b>256K X 36</b>				
BGA X 36	AS9C25256M2036L - 250BC	AS9C25256M2036L - 200BC	AS9C25256M2036L - 166BC	AS9C25256M2036L - 133BC
	AS9C25256M2036L - 250BI	AS9C25256M2036L - 200BI	AS9C25256M2036L - 166BI	AS9C25256M2036L - 133BI
fpBGA X 36	AS9C25256M2036L - 250FC	AS9C25256M2036L - 200FC	AS9C25256M2036L - 166FC	AS9C25256M2036L - 133FC
	AS9C25256M2036L - 250FI	AS9C25256M2036L - 200FI	AS9C25256M2036L - 166FI	AS9C25256M2036L - 133FI
PQFP X 36	AS9C25256M2036L - 250PC	AS9C25256M2036L - 200PC	AS9C25256M2036L - 166PC	AS9C25256M2036L - 133PC
	AS9C25256M2036L - 250PI	AS9C25256M2036L - 200PI	AS9C25256M2036L - 166PI	AS9C25256M2036L - 133PI
<b>128K X 36</b>				
BGA X 36	AS9C25128M2036L - 250BC	AS9C25128M2036L - 200BC	AS9C25128M2036L - 166BC	AS9C25128M2036L - 133BC
	AS9C25128M2036L - 250BI	AS9C25128M2036L - 200BI	AS9C25128M2036L - 166BI	AS9C25128M2036L - 133BI
fpBGA X 36	AS9C25128M2036L - 250FC	AS9C25128M2036L - 200FC	AS9C25128M2036L - 166FC	AS9C25128M2036L - 133FC
	AS9C25128M2036L - 250FI	AS9C25128M2036L - 200FI	AS9C25128M2036L - 166FI	AS9C25128M2036L - 133FI
PQFP X 36	AS9C25128M2036L - 250PC	AS9C25128M2036L - 200PC	AS9C25128M2036L - 166PC	AS9C25128M2036L - 133PC
	AS9C25128M2036L - 250PI	AS9C25128M2036L - 200PI	AS9C25128M2036L - 166PI	AS9C25128M2036L - 133PI

## Part Numbering Guide

AS	9C	25	256	M20	36	L	-XXX	P or B or F	C/I
1	2	3	4	5	6	7	8	9	10

1. Alliance Semiconductor prefix
2. Speciality Memory
3. Operating Voltage: 25 - VDD = 2.5V
4. Device depth: 256 - 256K; 128 - 128K
5. M20 - Multiport - 2port, SSRAM, DCD
6. I/O width - 36
7. I/O interface: L - LVTTTL
8. Clock speed (MHz)
9. Package Type: P - PQFP, B - BGA, F - fpBGA
10. Operating Temperature: C - Commercial (0°C to 70°C); I -Industrial (-40°C to 85°C)

AS9C25256M2036L  
AS9C25128M2036L



Alliance Semiconductor Corporation  
2575, Augustine Drive,  
Santa Clara, CA 95054  
Tel: 408 - 855 - 4900  
Fax: 408 - 855 - 4999  
[www.alsc.com](http://www.alsc.com)

Copyright © Alliance Semiconductor  
All Rights Reserved  
Preliminary Information  
Part Number: AS9C25256M2036L  
AS9C25128M2036L  
Document Version: v.1.3

© Copyright 2003 Alliance Semiconductor Corporation. All rights reserved. Our three-point logo, our name and Intelliwatt are trademarks or registered trademarks of Alliance. All other brand and product names may be the trademarks of their respective companies. Alliance reserves the right to make changes to this document and its products at any time without notice. Alliance assumes no responsibility for any errors that may appear in this document. The data contained herein represents Alliance's best data and/or estimates at the time of issuance. Alliance reserves the right to change or correct this data at any time, without notice. If the product described herein is under development, significant changes to these specifications are possible. The information in this product data sheet is intended to be general descriptive information for potential customers and users, and is not intended to operate as, or provide, any guarantee or warranty to any user or customer. Alliance does not assume any responsibility or liability arising out of the application or use of any product described herein, and disclaims any express or implied warranties related to the sale and/or use of Alliance products including liability or warranties related to fitness for a particular purpose, merchantability, or infringement of any intellectual property rights, except as expressly agreed to in Alliance's Terms and Conditions of Sale (which are available from Alliance). All sales of Alliance products are made exclusively according to Alliance's Terms and Conditions of Sale. The purchase of products from Alliance does not convey a license under any patent rights, copyrights, mask works rights, trademarks, or any other intellectual property rights of Alliance or third parties. Alliance does not authorize its products for use as critical components in life-supporting systems where a malfunction or failure may reasonably be expected to result in significant injury to the user, and the inclusion of Alliance products in such life-supporting systems implies that the manufacturer assumes all risk of such use and agrees to indemnify Alliance against all claims arising from such use.