

HAL114

Unipolar Hall Switch IC

Edition June 10, 1998
6251-456-1DS

 **MICRONAS**

INTERMETALL

Unipolar Hall Switch IC in CMOS technology

Introduction

The HAL114 is a Hall switch produced in CMOS technology. The sensor includes a temperature-compensated Hall plate, a Schmitt trigger, and an open-drain output transistor (see Fig. 2).

The HAL114 has a unipolar behavior: The output turns low with a magnetic south pole on the branded side of the package (see figures 3 and 4). The output turns high if the magnetic field is removed. The output signal remains high if the magnetic north pole approaches the branded side of the package.

The sensor is designed for industrial and automotive applications and operates with supply voltages from 4.5 V to 24 V in the ambient temperature range from -40°C up to 150°C .

The HAL114 is available in a SMD-package (SOT-89A) and in a leaded version (TO-92UA).

Features:

- operates from 4.5 V to 24 V supply voltage
- overvoltage protection
- reverse-voltage protection at V_{DD} -pin
- short-circuit protected open-drain output by thermal shutdown
- operates with magnetic fields from DC to 20 kHz
- stable magnetic switching points over a wide supply voltage range
- the decrease of magnetic flux density caused by rising temperature in the sensor system is compensated by a built-in negative temperature coefficient of the magnetic switching points
- ideal sensor for contactless switches and speed measurement in hostile automotive and industrial environments

Specifications

- switching type: unipolar
- output turns low with magnetic south pole on branded side of package
- output turns high if magnetic field is removed

Marking Code

Type	Temperature Range		
	A	E	C
HAL 114SO, HAL 114UA	114A	114E	114C

Operating Junction Temperature Range (T_{J})

A: $T_{\text{J}} = -40^{\circ}\text{C}$ to $+170^{\circ}\text{C}$

E: $T_{\text{J}} = -40^{\circ}\text{C}$ to $+100^{\circ}\text{C}$

C: $T_{\text{J}} = 0^{\circ}\text{C}$ to $+100^{\circ}\text{C}$

The relationship between ambient temperature (T_{A}) and junction temperature (T_{J}) is explained on page 8.

Hall Sensor Package Codes

HALXXXPA-T

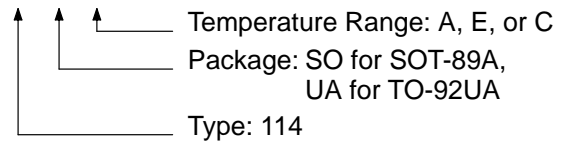

Example: **HAL 114UA-E**

→ Type: 114

→ Package: TO-92UA

→ Temperature Range: $T_{\text{J}} = -40^{\circ}\text{C}$ to $+100^{\circ}\text{C}$

Hall sensors are available in a wide variety of packaging versions and quantities. For more detailed information, please refer to the brochure: "Ordering Codes for Hall Sensors".

Solderability

- Package SOT-89A: according to IEC68-2-58
- Package TO-92UA: according to IEC68-2-20

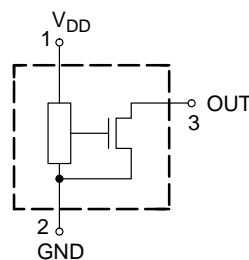

Fig. 1: Pin configuration

Functional Description

The HAL114 is a CMOS integrated circuit with a switching output in response to magnetic fields. It processes the "Hall Voltage" internally: The Hall Voltage is proportional to the magnetic flux component B_z orthogonal to an integrated Hall Plate, in case an electric current is imposed to the plate. The HAL114 compares the Hall Voltage with a predefined threshold and generates the output signal dependent of the direction of the magnetic field. A special circuit compensates for the temperature dependent effects of the IC, as well as the external magnet. A built-in hysteresis eliminates possible oscillations of the output signal adjacent to its switching point so that "output bouncing" is avoided. The output is short-circuit protected by limiting high currents and by sensing excess temperature. Shunt protection devices clamp voltage peaks at the Output-Pin and V_{DD} -Pin together with external series resistors. Reverse current is limited at the V_{DD} -Pin by an internal series resistor up to -15 V . No external reverse protection diode is needed at the V_{DD} -Pin for values ranging from 0 V to -15 V .

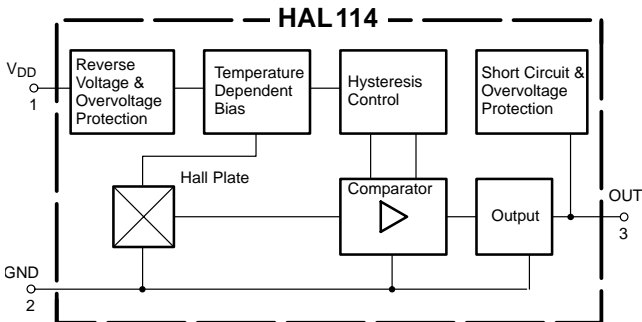

Fig. 2: HAL 114 block diagram

Dimensions of Sensitive Area

0.4 mm x 0.2 mm

Positions of Sensitive Area

SOT-89A	TO-92UA
$x = 0 \pm 0.2$	$x = 0 \pm 0.2$
$y = 0.98 \pm 0.2$	$y = 1.0 \pm 0.2$

x is referenced to the center of the package

Outline Dimensions

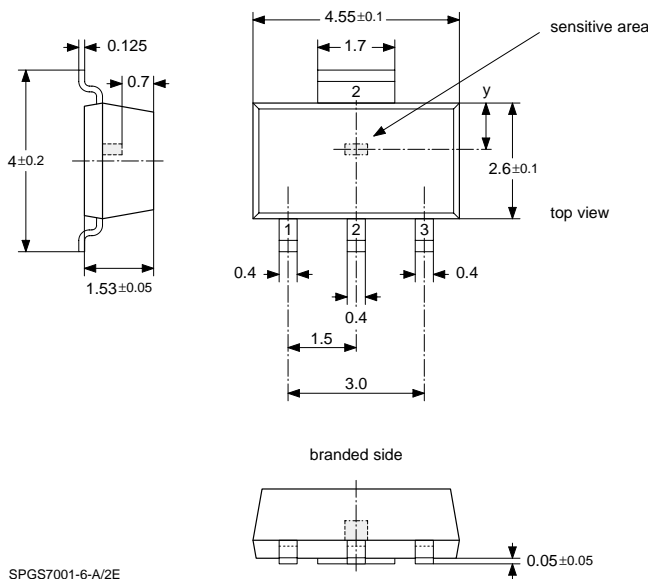

Fig. 3: Plastic Small Outline Transistor Package (SOT-89A)
Weight approximately 0.04 g
Dimensions in mm

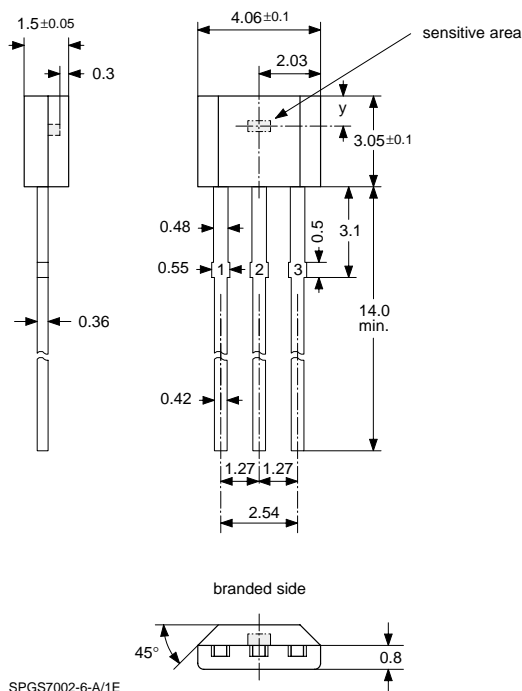

Fig. 4: Plastic Transistor Single Outline Package (TO-92UA)
Weight approximately 0.12 g
Dimensions in mm

Absolute Maximum Ratings

Symbol	Parameter	Pin No.	Min.	Max.	Unit
V_{DD}	Supply Voltage	1	-15	28 ¹⁾	V
$-V_P$	Test Voltage for Supply	1	-24 ²⁾	-	V
$-I_{DD}$	Reverse Supply Current	1	-	50 ¹⁾	mA
I_{DDZ}	Supply Current through Protection Device	1	-200 ³⁾	200 ³⁾	mA
V_O	Output Voltage	3	-0.3	28 ¹⁾	V
I_O	Continuous Output On Current	3	-	30	mA
I_{Omax}	Peak Output On Current	3	-	250 ³⁾	mA
I_{OZ}	Output Current through Protection Device	3	-200 ³⁾	200 ³⁾	mA
T_S	Storage Temperature Range		-65	150	°C
T_J	Junction Temperature Range		-40 -40	150 170 ⁴⁾	°C

¹⁾ as long as T_{Jmax} is not exceeded
²⁾ with a 220 Ω series resistance at pin 1 corresponding to test circuit 1
³⁾ $t < 2$ ms
⁴⁾ $t < 1000$ h

Stresses beyond those listed in the “Absolute Maximum Ratings” may cause permanent damage to the device. This is a stress rating only. Functional operation of the device at these or any other conditions beyond those indicated in the “Recommended Operating Conditions/Characteristics” of this specification is not implied. Exposure to absolute maximum ratings conditions for extended periods may affect device reliability.

Recommended Operating Conditions

Symbol	Parameter	Pin No.	Min.	Typ.	Max.	Unit
V_{DD}	Supply Voltage	1	4.5	-	24	V
I_O	Continuous Output On Current	3	0	-	20	mA
R_V	Series Resistor	1	-	-	270	Ω

Electrical Characteristics at $T_J = -40$ °C to $+170$ °C, $V_{DD} = 4.5$ V to 24 V, as not otherwise specified in Test Conditions
 Typical Characteristics for $T_J = 25$ °C and $V_{DD} = 12$ V

Symbol	Parameter	Pin No.	Min.	Typ.	Max.	Unit	Test Conditions
V_{OL}	Output Voltage over Temperature Range	3	-	120	400	mV	$I_{OL} = 12.5$ mA
V_{OL}	Output Voltage over Temperature Range	3	-	190	500	mV	$I_{OL} = 20$ mA
I_{OH}	Output Leakage Current	3	-	-	1	μ A	$B < B_{off}$, $V_{OH} = 24$ V, $T_J = 25$ °C

Electrical Characteristics, continued

Symbol	Parameter	Pin No.	Min.	Typ.	Max.	Unit	Test Conditions
I_{OH}	Output Leakage Current over Temperature Range	3	–	–	10	μA	$B < B_{off}$ $V_{OH} = 24 V, T_J < 150 ^\circ C$
I_{DD}	Supply Current	1	6	8.2	11	mA	$T_J = 25 ^\circ C$
I_{DD}	Supply Current over Temperature Range	1	3.9	8.2	12	mA	
$t_{en(O)}$	Enable Time of Output after Setting of V_{DD}	3	–	6	10	μs	$V_{DD} = 12 V$
t_r	Output Rise Time	3	–	85	400	ns	$V_{DD} = 12 V, R_L = 820 \text{ Ohm}, CL = 20 \text{ pF}$
t_f	Output Fall Time	3	–	60	400	ns	$V_{DD} = 12 V, R_L = 820 \text{ Ohm}, CL = 20 \text{ pF}$
R_{thJSB} case SOT-89A	Thermal Resistance Junction to Substrate Backside		–	150	200	K/W	Fiberglass Substrate pad size see Fig. 6
R_{thJA} case TO-92UA	Thermal Resistance Junction to Soldering Point		–	150	200	K/W	Leads at ambient temperature at a distance of 2 mm from case

Magnetic Characteristics at $T_J = -40 ^\circ C$ to $+170 ^\circ C$, $V_{DD} = 4.5 V$ to $24 V$, Typical Characteristics for $V_{DD} = 12 V$

Magnetic flux density values of switching points.
Positive flux density values refer to the magnetic south pole at the branded side of the package.

Parameter	-40 °C			25 °C			100 °C			170 °C			Unit
	Min.	Typ.	Max.	Min.	Typ.	Max.	Min.	Typ.	Max.	Min.	Typ.	Max.	
On point B_{ON}	7.5	21.5	36.0	7.0	21.3	34.0	6.3	19.6	31.5	6.0	19.2	31.0	mT
Off point B_{OFF}	4.3	17.4	33.2	4.0	17.6	31.2	3.6	16.1	28.9	3.6	15.8	28.8	mT
Hysteresis B_{HYS}	2.8	4.1	5.0	2.8	3.7	4.5	2.6	3.5	4.0	2.2	3.4	4.0	mT

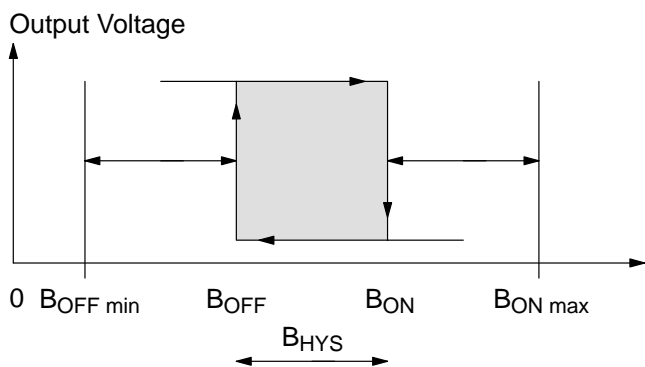

Fig. 5: Definition of switching points and hysteresis

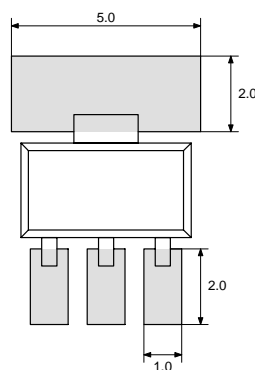
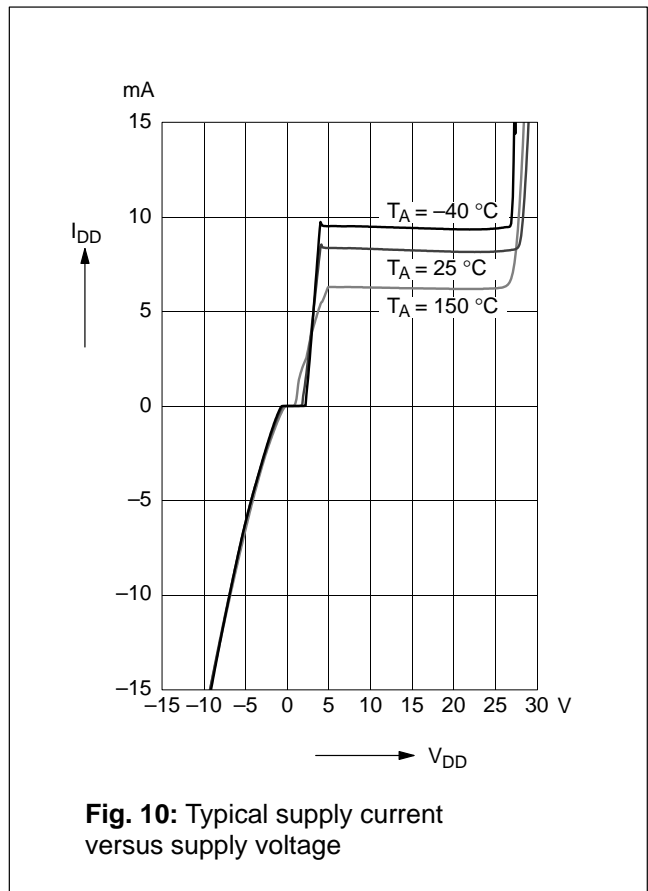
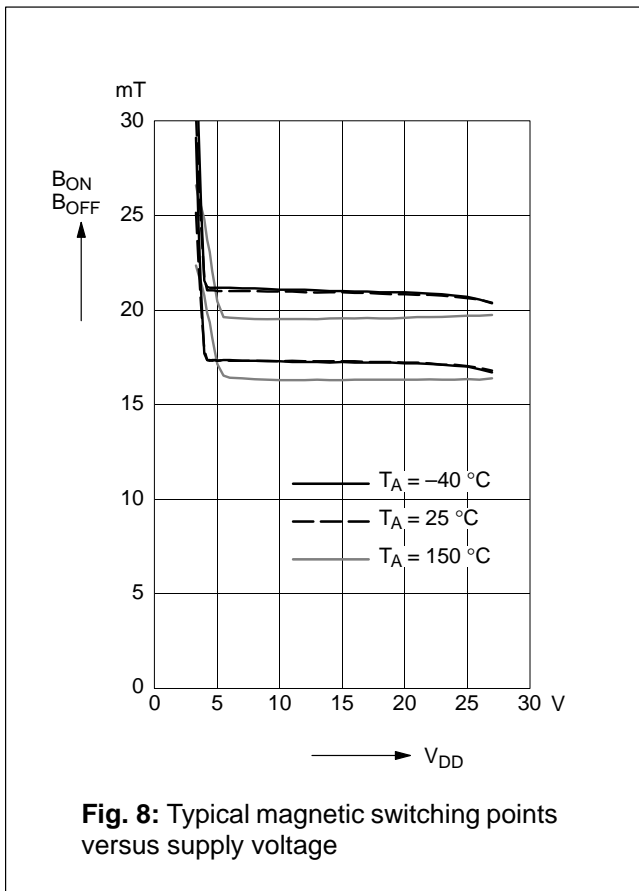
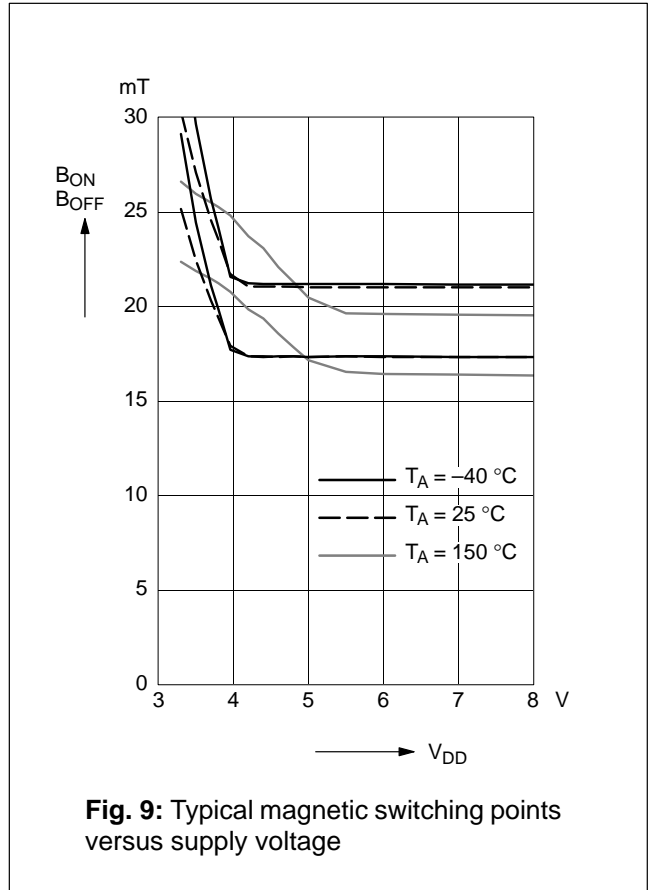
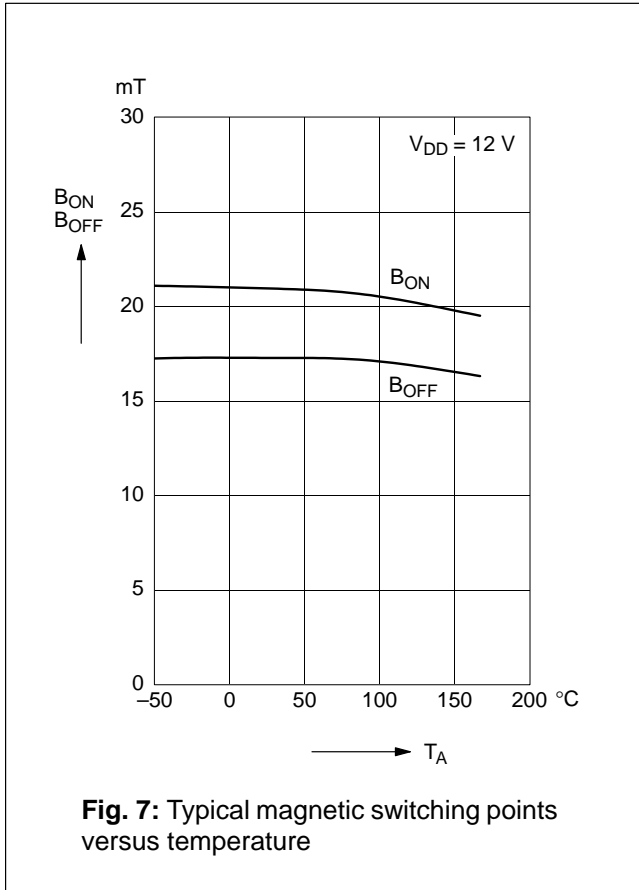
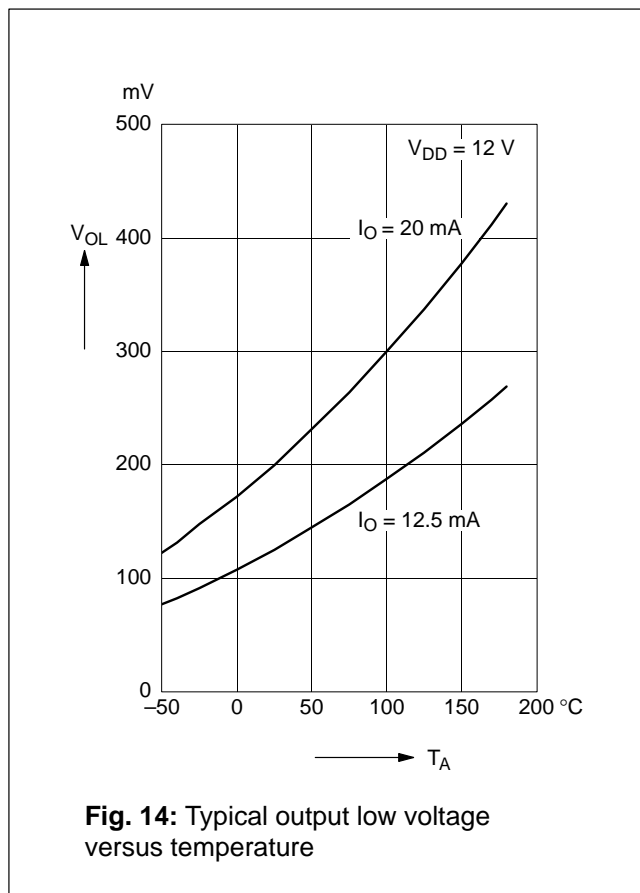
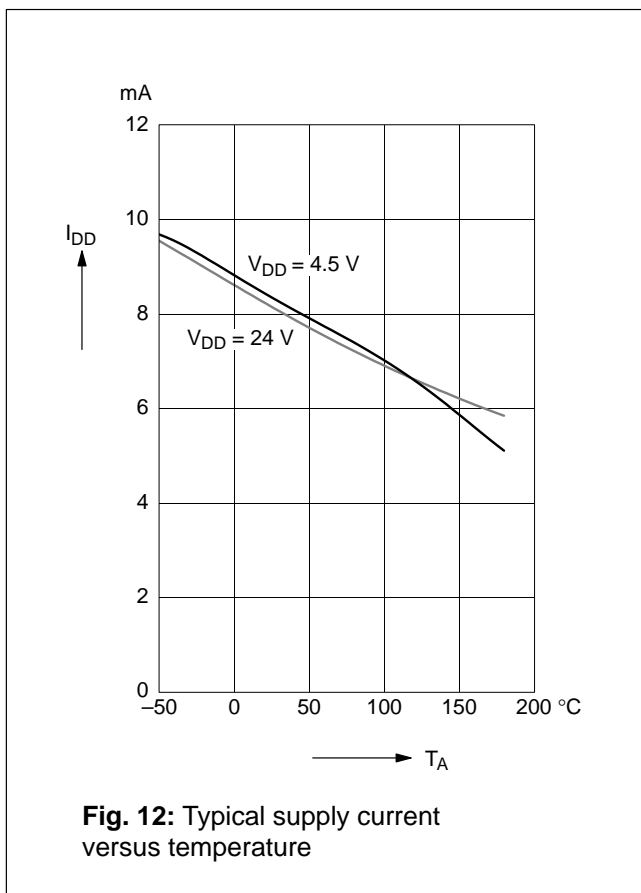
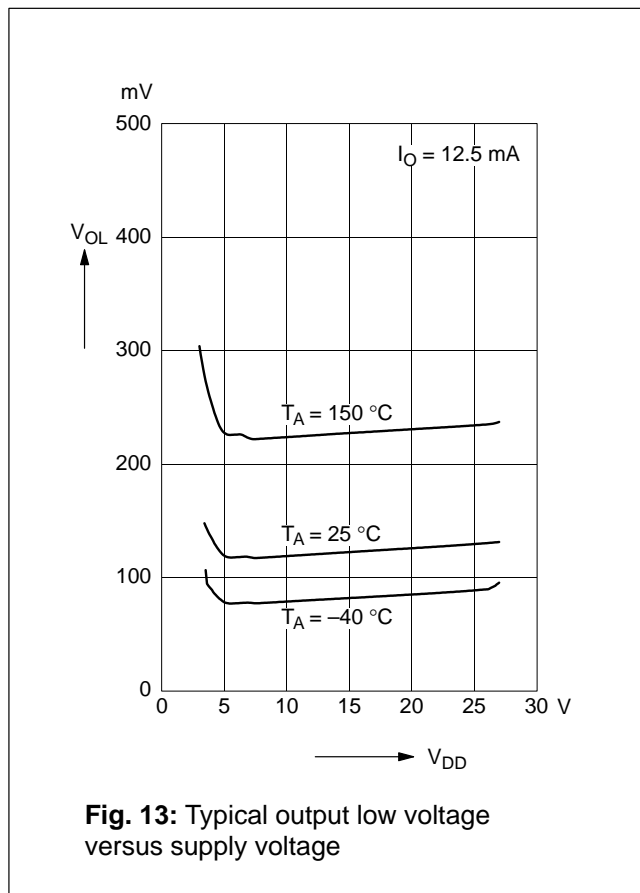
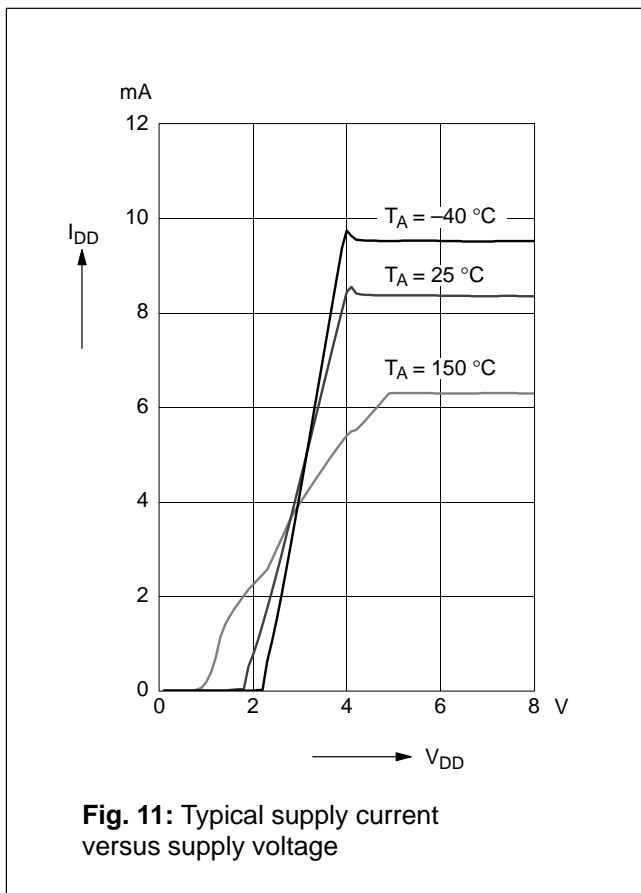
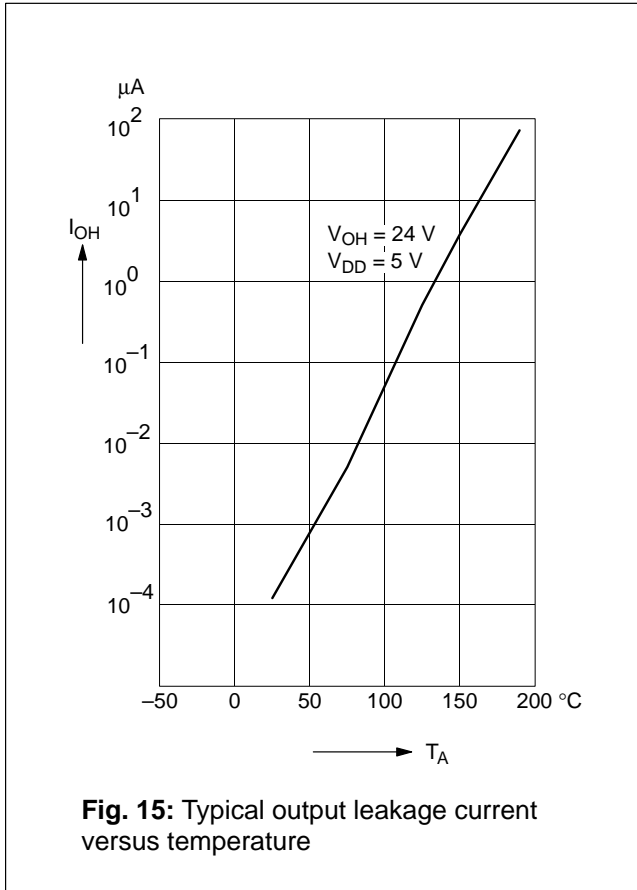

Fig. 6: Recommended pad size SOT-89A
Dimensions in mm







Application Note

For electromagnetic immunity, it is recommended to apply a 330 pF minimum capacitor between V_{DD} (pin 1) and Ground (pin 2).

For applications requiring robustness to conducted disturbances (transients), a 220 Ω series resistor to pin 1 and a 4.7 nF capacitor between V_{DD} (pin1) and Ground (pin 2) is recommended. The series resistor and the capacitor should be placed as close as possible to the IC.

MICRONAS INTERMETALL GmbH
 Hans-Bunte-Strasse 19
 D-79108 Freiburg (Germany)
 P.O. Box 840
 D-79008 Freiburg (Germany)
 Tel. +49-761-517-0
 Fax +49-761-517-2174
 E-mail: docservice@intermetall.de
 Internet: <http://www.intermetall.de>

Printed in Germany
 by Systemdruck+Verlags-GmbH, Freiburg (06/98)
 Order No. 6251-456-1DS

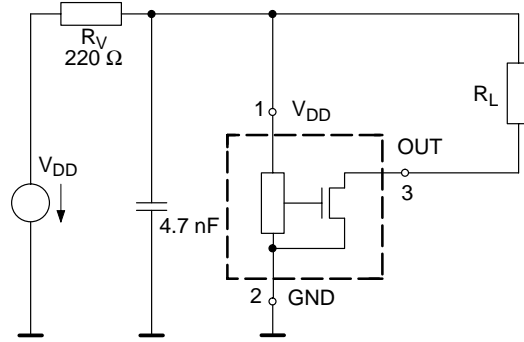

Fig. 16: Recommended application circuit

Ambient Temperature

Due to the internal power dissipation, the temperature on the silicon chip (junction temperature T_J) is higher than the temperature outside the package (ambient temperature T_A).

$$T_J = T_A + \Delta T$$

At static conditions, the following equations are valid:

- for SOT-89A: $\Delta T = I_{DD} \cdot V_{DD} \cdot R_{thJSB}$
- for TO-92UA: $\Delta T = I_{DD} \cdot V_{DD} \cdot R_{thJA}$

For typical values, use the typical parameters. For worst case calculation, use the max. parameters for I_{DD} and R_{th}, and the max. value for V_{DD} from the application.

Data Sheet History

1. Final data sheet: "HAL114 Unipolar Hall Switch IC", June 10, 1998, 6251-456-1DS. First release of the final data sheet.

All information and data contained in this data sheet are without any commitment, are not to be considered as an offer for conclusion of a contract nor shall they be construed as to create any liability. Any new issue of this data sheet invalidates previous issues. Product availability and delivery dates are exclusively subject to our respective order confirmation form; the same applies to orders based on development samples delivered. By this publication, MICRONAS INTERMETALL GmbH does not assume responsibility for patent infringements or other rights of third parties which may result from its use. Reprinting is generally permitted, indicating the source. However, our prior consent must be obtained in all cases.

End of Data Sheet

Back to Summary



Back to Data Sheets

