

TYPICAL INDICATOR ORDERING EXAMPLE



Models	
01	Low .079" (2.0mm) Profile
02	High .291" (7.4mm) Profile

PC Terminals	
For 01 Model	
P	Straight
B	Straight with Bracket
H	Right Angle
V	Vertical
For 02 Model	
P	Straight

LED Colors	
C	Red
E	Yellow
F	Green

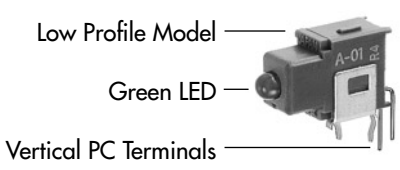

A01VF

DESCRIPTION FOR TYPICAL ORDERING EXAMPLES

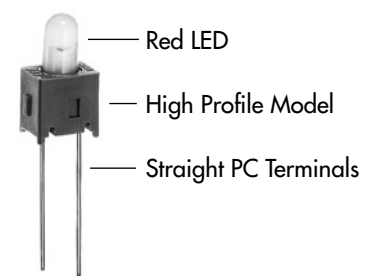

A02PC

PC TERMINALS

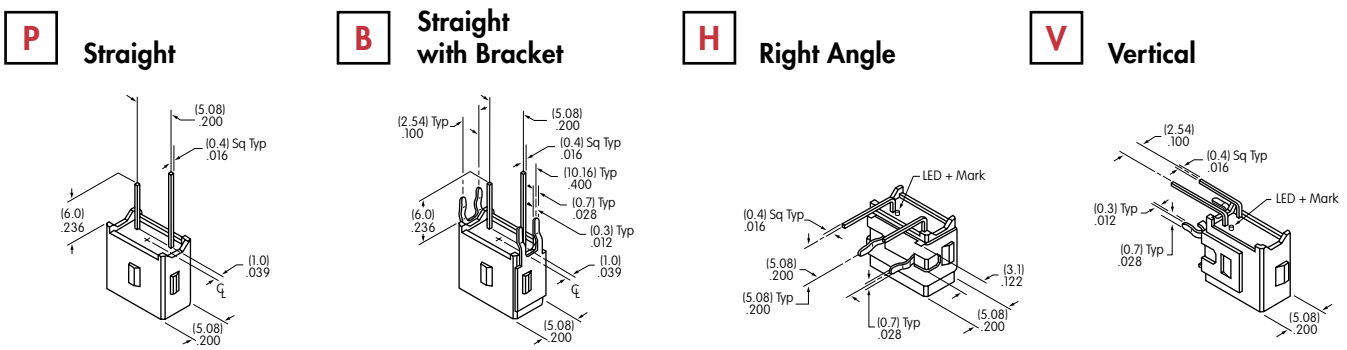

LED COLORS & SPECIFICATIONS

Models	A01 Indicator			A02 Indicator		
	C	E	F	C	E	F
LED is colored in OFF state	Red	Yellow	Green	Red	Yellow	Green
Forward Peak Current	I_{FM} 50mA	50mA	50mA	25mA	30mA	30mA
Continuous Forward Current	I_F 30mA	30mA	30mA	20mA	20mA	20mA
Forward Voltage	V_F 1.7V	2.2V	2.1V	2.1V	2.1V	2.2V
Reverse Peak Voltage	V_{RM} 4V	4V	4V	4V	4V	4V
Current Reduction Rate Above 25°C	ΔI_F 0.67mA/°C	0.67mA/°C	0.67mA/°C	0.33mA/°C	0.40mA/°C	0.40mA/°C
Ambient Temperature Range	-30°C ~ +85°C			-30°C ~ +85°C		

Electrical specifications are determined at a basic temperature of 25°C.
 If the source voltage is greater than the LED's rated voltage, a ballast resistor must be connected in series with the LED.
 The ballast resistor value can be calculated by using the formula shown in the Supplement section.

Toggles
 Rockers
 Pushbuttons
 Illuminated PB
 Programmable
 Keylocks
 Rotaries
 Slides
 Tactiles
 Tilt
 Touch
 Indicators
 Accessories
 Supplement

TYPICAL INDICATOR DIMENSIONS

Straight PC

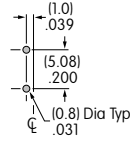
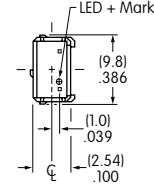
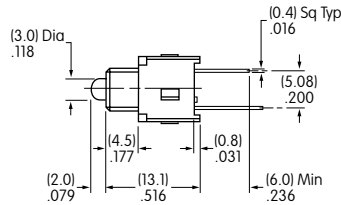
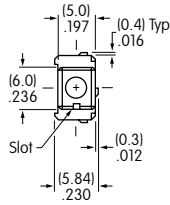

A01PF

Straight PC • Bracket

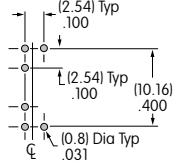
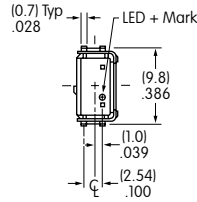
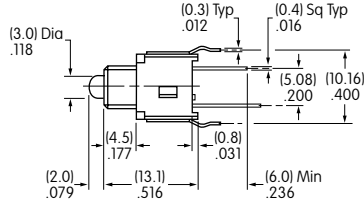
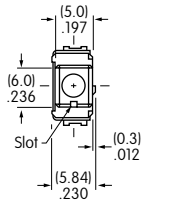

A01BF

Right Angle PC

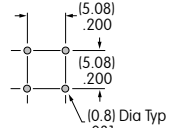
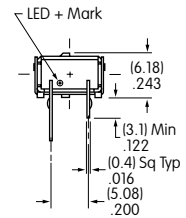
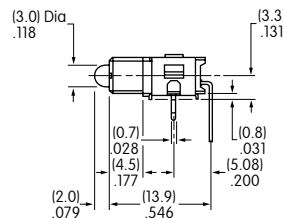
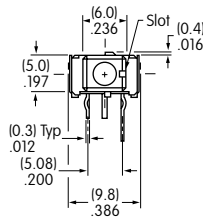

A01HF

Vertical PC

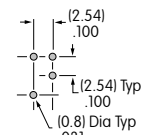
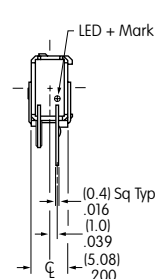
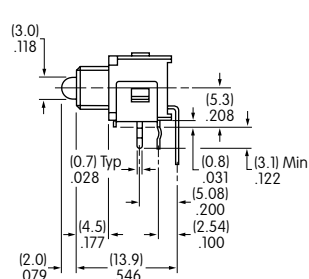
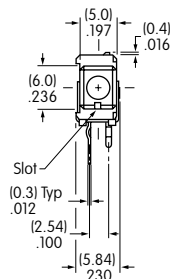

A01VF

Straight PC

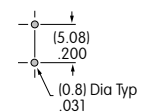
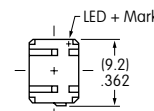
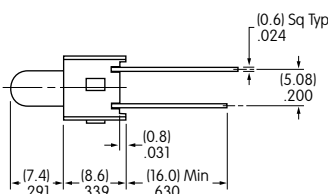
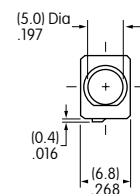

A02PF

Toggles

Rockers

Pushbuttons

Programmable

Illuminated PB

Keylocks

Rotaries

Slides

Tactiles

Tilt

Touch

Indicators

Accessories

Supplement

Mouser Electronics

Authorized Distributor

Click to View Pricing, Inventory, Delivery & Lifecycle Information:

[NKK Switches:](#)

[A01HF-RO](#) [A02PF](#) [A01PC](#) [A01PE](#) [A01PF](#) [A01VF](#)