

- NOTE:
- MATERIAL:
HOUSING: PA46 GLASS FILLED, UL94V-0, COLOR: NATURAL
TERMINAL: COPPER ALLOY
 - PLATING:
1) 0.10 μm MIN. GOLD PLATING OVER NICKEL PLATING OVERALL
2) 1-3 μm TIN-BISMUTH PLATING OVER NICKEL PLATING OVERALL
 - PRODUCT SPECIFICATION: PS-78119-001
 - PRODUCT ARE PACKED IN TAPE & REEL.

REVISED	IEC NO: J2013-0629	DESCRIPTION	QUALITY SYMBOLS
	DRWN:TMORISHITA 2012/11/30		▽F=0
B	CHKD:KTAKAHASHI 2012/11/30	REV	▽F=0
	APPR:KMORIKAWA 2012/12/11		▽F=0

GENERAL TOLERANCES (UNLESS SPECIFIED)	
	mm INCH
4 PLACES	± --- ± ---
3 PLACES	± --- ± ---
2 PLACES	± 0.15 ± ---
1 PLACE	± --- ± ---
0 PLACE	± ±
ANGULAR ± 3 °	
DRAFT WHERE APPLICABLE MUST REMAIN WITHIN DIMENSIONS	

DIMENSION STYLE	
MM ONLY	
DRAWN BY	DATE
YLOIAO	2006/05/05
CHECKED BY	DATE
BOKOK	2006/06/06
APPROVED BY	DATE
PTLIM	2006/06/06
MATERIAL NO.	
SEE TABLE	
SIZE	A3

SCALE	NTS	DESIGN UNITS	METRIC	THIRD ANGLE PROJECTION
TITLE				
0.50MM PITCH, FPC CONN. NON-ZIF, SMT				
DOCUMENT NO.			SHEET NO.	
SD-78127-001			1 OF 7	
molex				
THIS DRAWING CONTAINS INFORMATION THAT IS PROPRIETARY TO MOLEX INCORPORATED AND SHOULD NOT BE USED WITHOUT WRITTEN PERMISSION				

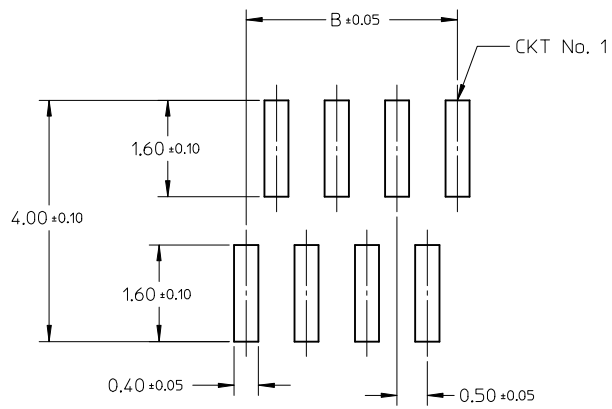

RECOMMENDED PCB LAYOUT

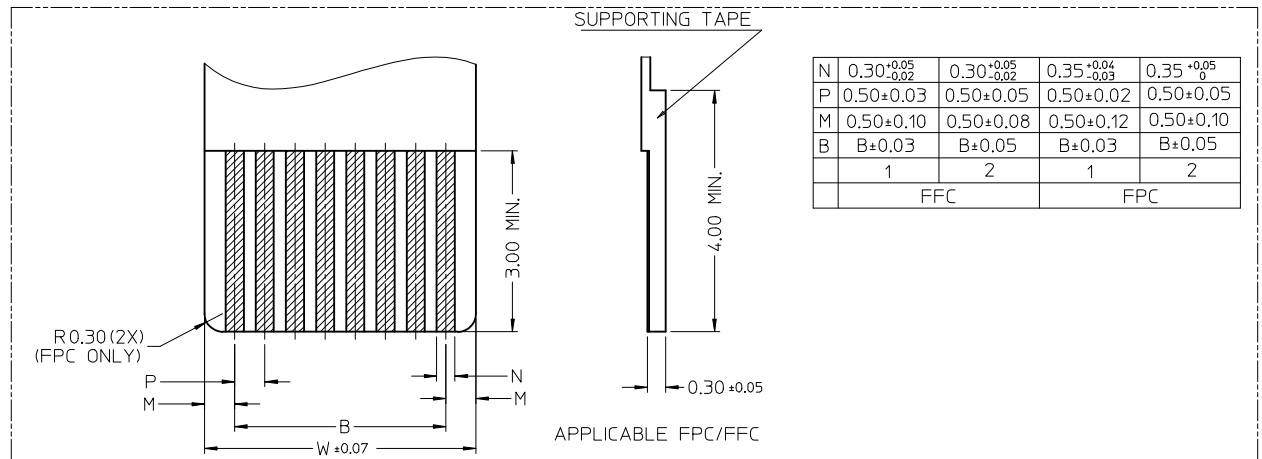

N	0.30 ^{+0.05} _{-0.02}	0.30 ^{+0.05} _{-0.02}	0.35 ^{+0.04} _{-0.03}	0.35 ^{+0.05} ₀
P	0.50±0.03	0.50±0.05	0.50±0.02	0.50±0.05
M	0.50±0.10	0.50±0.08	0.50±0.12	0.50±0.10
B	B±0.03	B±0.05	B±0.03	B±0.05
	1	2	1	2
	FFC		FPC	

REVISED EC NO: J2013-0629 DRWN: TMORI SHITA 2012/11/30 CH'KD: TAKAHASHI 2012/11/30 APPR: KMORI KAWA 2012/12/11	QUALITY SYMBOLS $\nabla F = 0$ $\nabla F = 0$ $\nabla F = 0$	GENERAL TOLERANCES (UNLESS SPECIFIED) mm INCH 4 PLACES ± --- ± --- 3 PLACES ± --- ± --- 2 PLACES ± 0.15 ± --- 1 PLACE ± --- ± --- 0 PLACE ± ±	DIMENSION STYLE MM ONLY	SCALE NTS	DESIGN UNITS METRIC	THIRD ANGLE PROJECTION	
	DRAWN BY: YLQ1A0 CHECKED BY: BOKOK APPROVED BY: PTL IM	DATE: 2006/05/05 DATE: 2006/06/06 DATE: 2006/06/06	TITLE 0.50MM PITCH, FPC CONN. NON-ZIF, SMT	MATERIAL NO. SEE TABLE	DOCUMENT NO. SD-78127-001	SHEET NO. 2 OF 7	THIS DRAWING CONTAINS INFORMATION THAT IS PROPRIETARY TO MOLEX INCORPORATED AND SHOULD NOT BE USED WITHOUT WRITTEN PERMISSION
	DRAFT WHERE APPLICABLE MUST REMAIN WITHIN DIMENSIONS	ANGULAR ± 3 °	SIZE A3	molex			
	REV B	REV	DRAFT WHERE APPLICABLE MUST REMAIN WITHIN DIMENSIONS	molex			

GOLD PLATING TERMINAL ASSEMBLY PART NUMBERS

ASSY P/N W/O PACKAGING	CKT	DIM A	DIM B	DIM C	DIM D	PLATING TYPE
78127-0108	10	7.10	4.50	6.40	5.60	1
78127-0118	11	7.60	5.00	6.90	6.10	
78127-0128	12	8.10	5.50	7.40	6.60	
78127-0138	13	8.60	6.00	7.90	7.10	
78127-0148	14	9.10	6.50	8.40	7.60	
78127-0158	15	9.60	7.00	8.90	8.10	
78127-0168	16	10.10	7.50	9.40	8.60	
78127-0178	17	10.60	8.00	9.90	9.10	
78127-0188	18	11.10	8.50	10.40	9.60	
78127-0198	19	11.60	9.00	10.90	10.10	
78127-0208	20	12.10	9.50	11.40	10.60	
78127-0218	21	12.60	10.00	11.90	11.10	
78127-0228	22	13.10	10.50	12.40	11.60	
78127-0238	23	13.60	11.00	12.90	12.10	
78127-0248	24	14.10	11.50	13.40	12.60	
78127-0258	25	14.60	12.00	13.90	13.10	
78127-0268	26	15.10	12.50	14.40	13.60	
78127-0278	27	15.60	13.00	14.90	14.10	
78127-0288	28	16.10	13.50	15.40	14.60	
78127-0298	29	16.60	14.00	15.90	15.10	
78127-0308	30	17.10	14.50	16.40	15.60	

ASSY P/N W/O PACKAGING	CKT	DIM A	DIM B	DIM C	DIM D	PLATING TYPE
78127-0318	31	17.60	15.00	16.90	16.10	1
78127-0328	32	18.10	15.50	17.40	16.60	
78127-0338	33	18.60	16.00	17.90	17.10	
78127-0348	34	19.10	16.50	18.40	17.60	
78127-0358	35	19.60	17.00	18.90	18.10	
78127-0368	36	20.10	17.50	19.40	18.60	
78127-0378	37	20.60	18.00	19.90	19.10	
78127-0388	38	21.10	18.50	20.40	19.60	
78127-0398	39	21.60	19.00	20.90	20.10	
78127-0408	40	22.10	19.50	21.40	20.60	

REVISED EC NO: J2013-0629 DRWN: TMORISHITA 2012/11/30 CHKD: KAKAHASHI 2012/11/30 APPR: KMORIKAWA 2012/12/11	QUALITY SYMBOLS	GENERAL TOLERANCES (UNLESS SPECIFIED)	DIMENSION STYLE	SCALE	DESIGN UNITS	THIRD ANGLE PROJECTION	
	$F_A=0$ $F_G=0$ $F_P=0$	mm INCH 4 PLACES ± --- ± --- 3 PLACES ± --- ± --- 2 PLACES ± 0.15 ± --- 1 PLACE ± --- ± --- 0 PLACE ± ±	MM ONLY	NTS	METRIC		
		ANGULAR ± 3 °	DRAWN BY: YLQIAO DATE: 2006/05/05	TITLE	0.50MM PITCH, FPC CONN. NON-ZIF, SMT		
		DRAFT WHERE APPLICABLE MUST REMAIN WITHIN DIMENSIONS	CHECKED BY: BOKOK DATE: 2006/06/06		molex		
		APPROVED BY: PTLIM DATE: 2006/06/06	MATERIAL NO.	DOCUMENT NO.	SHEET NO.		
			SEE TABLE		SD-78127-001	3 OF 7	
			THIS DRAWING CONTAINS INFORMATION THAT IS PROPRIETARY TO MOLEX INCORPORATED AND SHOULD NOT BE USED WITHOUT WRITTEN PERMISSION				

TIN-BISMUTH PLATING TERMINAL ASSEMBLY PART NUMBERS

ASSY P/N W/O PACKAGING	CKT	DIM A	DIM B	DIM C	DIM D	PLATING TYPE
78127-0109	10	7.10	4.50	6.40	5.60	2
78127-0119	11	7.60	5.00	6.90	6.10	
78127-0129	12	8.10	5.50	7.40	6.60	
78127-0139	13	8.60	6.00	7.90	7.10	
78127-0149	14	9.10	6.50	8.40	7.60	
78127-0159	15	9.60	7.00	8.90	8.10	
78127-0169	16	10.10	7.50	9.40	8.60	
78127-0179	17	10.60	8.00	9.90	9.10	
78127-0189	18	11.10	8.50	10.40	9.60	
78127-0199	19	11.60	9.00	10.90	10.10	
78127-0209	20	12.10	9.50	11.40	10.60	
78127-0219	21	12.60	10.00	11.90	11.10	
78127-0229	22	13.10	10.50	12.40	11.60	
78127-0239	23	13.60	11.00	12.90	12.10	
78127-0249	24	14.10	11.50	13.40	12.60	
78127-0259	25	14.60	12.00	13.90	13.10	
78127-0269	26	15.10	12.50	14.40	13.60	
78127-0279	27	15.60	13.00	14.90	14.10	
78127-0289	28	16.10	13.50	15.40	14.60	
78127-0299	29	16.60	14.00	15.90	15.10	
78127-0309	30	17.10	14.50	16.40	15.60	

ASSY P/N W/O PACKAGING	CKT	DIM A	DIM B	DIM C	DIM D	PLATING TYPE
78127-0319	31	17.60	15.00	16.90	16.10	2
78127-0329	32	18.10	15.50	17.40	16.60	
78127-0339	33	18.60	16.00	17.90	17.10	
78127-0349	34	19.10	16.50	18.40	17.60	
78127-0359	35	19.60	17.00	18.90	18.10	
78127-0369	36	20.10	17.50	19.40	18.60	
78127-0379	37	20.60	18.00	19.90	19.10	
78127-0389	38	21.10	18.50	20.40	19.60	
78127-0399	39	21.60	19.00	20.90	20.10	
78127-0409	40	22.10	19.50	21.40	20.60	

REVISED EC NO: J2013-0629 DRWN: TMORI SHITA 2012/11/30 CHKD: KATAHASHI 2012/11/30 APPR: KMORI KAWA 2012/12/11	QUALITY SYMBOLS $F_A=0$ $F_C=0$ $F_P=0$	GENERAL TOLERANCES (UNLESS SPECIFIED) mm INCH 4 PLACES ± --- ± --- 3 PLACES ± --- ± --- 2 PLACES ± 0.15 ± --- 1 PLACE ± --- ± --- 0 PLACE ± ± ANGULAR ± 3 ° DRAFT WHERE APPLICABLE MUST REMAIN WITHIN DIMENSIONS	DIMENSION STYLE MM ONLY DRAWN BY DATE YLQIAO 2006/05/05 CHECKED BY DATE BOKOK 2006/06/06 APPROVED BY DATE PTLIM 2006/06/06 MATERIAL NO.	SCALE NTS DESIGN UNITS METRIC THIRD ANGLE PROJECTION	TITLE 0.50MM PITCH, FPC CONN. NON-ZIF, SMT molex DOCUMENT NO. SD-78127-001 SHEET NO. 4 OF 7	
			SEE TABLE THIS DRAWING CONTAINS INFORMATION THAT IS PROPRIETARY TO MOLEX INCORPORATED AND SHOULD NOT BE USED WITHOUT WRITTEN PERMISSION			

EMBOSSED TYPE A

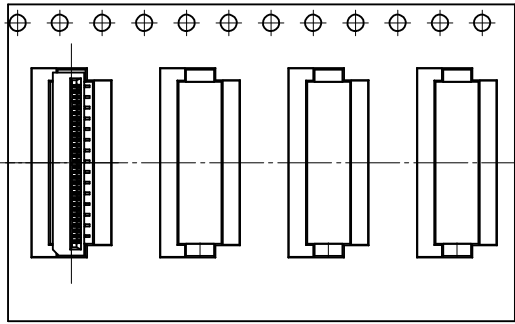

CUSTOMER
PULL OUT DIRECTION

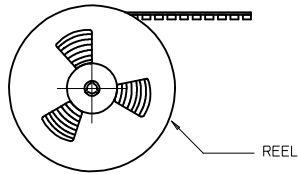

REEL

NOTES:

1. LEADER AND TRAILER TAPE

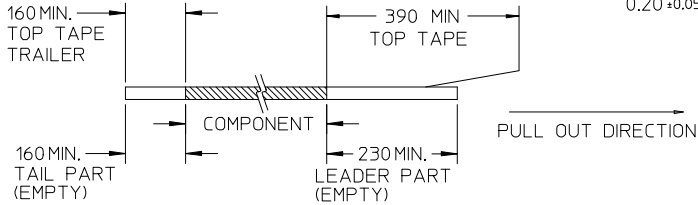

2. PEELING OFF FORCE OF THE TOP TAPE: 20-80gf.
(PEELING DIRECTION AS SHOWN IN FOLLOWING FIGURE)

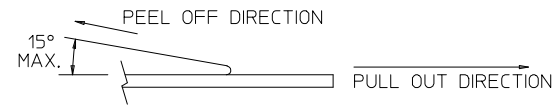

3. PACKAGING STANDARD IS AS PER EIA-481.
4. TAPE & REEL QUANTITY = 1000 PCS/REEL

EMBOSSED TYPE B

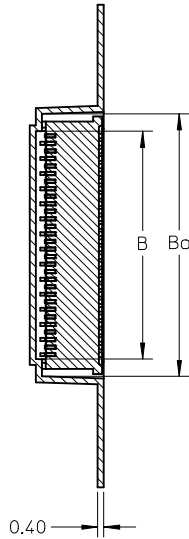
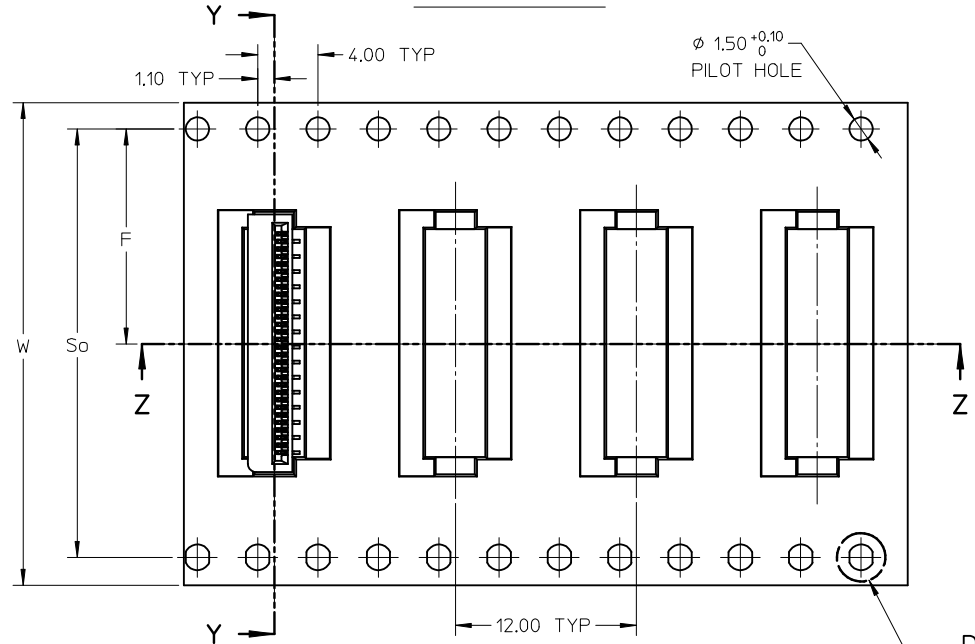

SECTION Y-Y

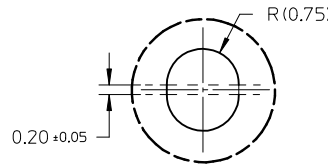

DETAIL 1

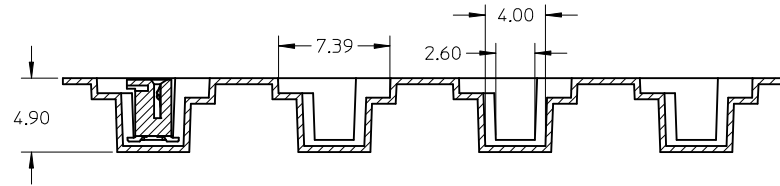

SECTION Z-Z

DETAIL 1

REVISED EC NO: J2013-0629 DRWN: TMORI SHITA 2012/11/30 CHKD: K TAKAHASHI 2012/11/30 APPR: K MORIKAWA 2012/12/11	DESCRIPTION REV	QUALITY SYMBOLS	GENERAL TOLERANCES (UNLESS SPECIFIED)		DIMENSION STYLE MM ONLY		SCALE NTS	DESIGN UNITS METRIC	THIRD ANGLE PROJECTION		
		$\nabla_{\text{A}}=0$	4 PLACES	mm	INCH	DRAWN BY YLQIAO	DATE 2006/05/05	TITLE 0.50MM PITCH, FPC CONN. NON-ZIF, SMT			
		$\nabla_{\text{C}}=0$	3 PLACES			CHECKED BY BOKOK	DATE 2006/06/06				
		$\nabla_{\text{B}}=0$	2 PLACES			APPROVED BY PTLIM	DATE 2006/06/06				
			0 PLACE			MATERIAL NO.	DOCUMENT NO.		SHEET NO.		
				ANGULAR $\pm 3^\circ$		SEE TABLE		SD-78127-001		5 OF 7	
		DRAFT WHERE APPLICABLE MUST REMAIN WITHIN DIMENSIONS		THIS DRAWING CONTAINS INFORMATION THAT IS PROPRIETARY TO MOLEX INCORPORATED AND SHOULD NOT BE USED WITHOUT WRITTEN PERMISSION							

GOLD PLATING TERMINAL ASSEMBLY PART NUMBERS

ASSY P/N PACKED IN T&R	ASSY P/N W/O PACKAGING	CKT	W	So	F	Bo	B	EMBOSSSED TYPE
78127-1108	78127-0108	10	24.00	-	11.50	7.40	5.10	A
78127-1118	78127-0118	11	24.00	-	11.50	7.90	5.60	
78127-1128	78127-0128	12	24.00	-	11.50	8.40	6.10	
78127-1138	78127-0138	13	24.00	-	11.50	8.90	6.60	
78127-1148	78127-0148	14	24.00	-	11.50	9.40	7.10	
78127-1158	78127-0158	15	24.00	-	11.50	9.90	7.60	
78127-1168	78127-0168	16	24.00	-	11.50	10.40	8.10	
78127-1178	78127-0178	17	24.00	-	11.50	10.90	8.60	
78127-1188	78127-0188	18	24.00	-	11.50	11.40	9.10	
78127-1198	78127-0198	19	24.00	-	11.50	11.90	9.60	
78127-1208	78127-0208	20	24.00	-	11.50	12.40	10.10	
78127-1218	78127-0218	21	32.00	28.40	14.20	12.90	10.60	B
78127-1228	78127-0228	22	32.00	28.40	14.20	13.40	11.10	
78127-1238	78127-0238	23	32.00	28.40	14.20	13.90	11.60	
78127-1248	78127-0248	24	32.00	28.40	14.20	14.40	12.10	
78127-1258	78127-0258	25	32.00	28.40	14.20	14.90	12.60	
78127-1268	78127-0268	26	32.00	28.40	14.20	15.40	13.10	
78127-1278	78127-0278	27	32.00	28.40	14.20	15.90	13.60	
78127-1288	78127-0288	28	32.00	28.40	14.20	16.40	14.10	
78127-1298	78127-0298	29	32.00	28.40	14.20	16.90	14.60	
78127-1308	78127-0308	30	32.00	28.40	14.20	17.40	15.10	

ASSY P/N PACKED IN T&R	ASSY P/N W/O PACKAGING	CKT	W	So	F	Bo	B	EMBOSSSED TYPE
78127-1318	78127-0318	31	32.00	28.40	14.20	17.90	15.60	B
78127-1328	78127-0328	32	32.00	28.40	14.20	18.40	16.10	
78127-1338	78127-0338	33	32.00	28.40	14.20	18.90	16.60	
78127-1348	78127-0348	34	32.00	28.40	14.20	19.40	17.10	
78127-1358	78127-0358	35	32.00	28.40	14.20	19.90	17.60	
78127-1368	78127-0368	36	32.00	28.40	14.20	20.40	18.10	
78127-1378	78127-0378	37	32.00	28.40	14.20	20.90	18.60	
78127-1388	78127-0388	38	32.00	28.40	14.20	21.40	19.10	
78127-1398	78127-0398	39	44.00	40.40	20.20	21.90	19.60	
78127-1408	78127-0408	40	44.00	40.40	20.20	22.40	20.10	

REVISED EC NO: JZ013-0629 DRWN: TMORI SHITA 2012/11/30 CHKDK: TAKAHASHI 2012/11/30 APPR: KMORI KAWA 2012/12/11	QUALITY SYMBOLS $\nabla_A = 0$ $\nabla_B = 0$ $\nabla_C = 0$	GENERAL TOLERANCES (UNLESS SPECIFIED) <table border="1"> <tr><th></th><th>mm</th><th>INCH</th></tr> <tr><td>4 PLACES</td><td>± ---</td><td>± ---</td></tr> <tr><td>3 PLACES</td><td>± ---</td><td>± ---</td></tr> <tr><td>2 PLACES</td><td>± 0.15</td><td>± ---</td></tr> <tr><td>1 PLACE</td><td>± ---</td><td>± ---</td></tr> <tr><td>0 PLACE</td><td>±</td><td>±</td></tr> </table>		mm	INCH	4 PLACES	± ---	± ---	3 PLACES	± ---	± ---	2 PLACES	± 0.15	± ---	1 PLACE	± ---	± ---	0 PLACE	±	±	DIMENSION STYLE MM ONLY DRAWN BY: YLQIAO DATE: 2006/05/05 CHECKED BY: BOKOK DATE: 2006/06/06 APPROVED BY: PTLIM DATE: 2006/06/06	SCALE: NTS DESIGN UNITS: METRIC THIRD ANGLE PROJECTION	TITLE: 0.50MM PITCH, FPC CONN. NON-ZIF, SMT molex DOCUMENT NO. SD-78127-001	SHEET NO. 6 OF 7
		mm	INCH																					
	4 PLACES	± ---	± ---																					
	3 PLACES	± ---	± ---																					
2 PLACES	± 0.15	± ---																						
1 PLACE	± ---	± ---																						
0 PLACE	±	±																						
DRAFT WHERE APPLICABLE MUST REMAIN WITHIN DIMENSIONS	MATERIAL NO. SEE TABLE	THIS DRAWING CONTAINS INFORMATION THAT IS PROPRIETARY TO MOLEX INCORPORATED AND SHOULD NOT BE USED WITHOUT WRITTEN PERMISSION																						
SIZE: A3																								
REV: B																								

TIN-BISMUTH PLATING TERMINAL ASSEMBLY PART NUMBERS

ASSY P/N PACKED IN T&R	ASSY P/N W/O PACKAGING	CKT	W	So	F	Bo	B	EMBOSSED TYPE
78127-1109	78127-0109	10	24.00	-	11.50	7.40	5.10	A
78127-1119	78127-0119	11	24.00	-	11.50	7.90	5.60	
78127-1129	78127-0129	12	24.00	-	11.50	8.40	6.10	
78127-1139	78127-0139	13	24.00	-	11.50	8.90	6.60	
78127-1149	78127-0149	14	24.00	-	11.50	9.40	7.10	
78127-1159	78127-0159	15	24.00	-	11.50	9.90	7.60	
78127-1169	78127-0169	16	24.00	-	11.50	10.40	8.10	
78127-1179	78127-0179	17	24.00	-	11.50	10.90	8.60	
78127-1189	78127-0189	18	24.00	-	11.50	11.40	9.10	
78127-1199	78127-0199	19	24.00	-	11.50	11.90	9.60	
78127-1209	78127-0209	20	24.00	-	11.50	12.40	10.10	
78127-1219	78127-0219	21	32.00	28.40	14.20	12.90	10.60	B
78127-1229	78127-0229	22	32.00	28.40	14.20	13.40	11.10	
78127-1239	78127-0239	23	32.00	28.40	14.20	13.90	11.60	
78127-1249	78127-0249	24	32.00	28.40	14.20	14.40	12.10	
78127-1259	78127-0259	25	32.00	28.40	14.20	14.90	12.60	
78127-1269	78127-0269	26	32.00	28.40	14.20	15.40	13.10	
78127-1279	78127-0279	27	32.00	28.40	14.20	15.90	13.60	
78127-1289	78127-0289	28	32.00	28.40	14.20	16.40	14.10	
78127-1299	78127-0299	29	32.00	28.40	14.20	16.90	14.60	
78127-1309	78127-0309	30	32.00	28.40	14.20	17.40	15.10	

ASSY P/N PACKED IN T&R	ASSY P/N W/O PACKAGING	CKT	W	So	F	Bo	B	EMBOSSED TYPE
78127-1319	78127-0319	31	32.00	28.40	14.20	17.90	15.60	B
78127-1329	78127-0329	32	32.00	28.40	14.20	18.40	16.10	
78127-1339	78127-0339	33	32.00	28.40	14.20	18.90	16.60	
78127-1349	78127-0349	34	32.00	28.40	14.20	19.40	17.10	
78127-1359	78127-0359	35	32.00	28.40	14.20	19.90	17.60	
78127-1369	78127-0369	36	32.00	28.40	14.20	20.40	18.10	
78127-1379	78127-0379	37	32.00	28.40	14.20	20.90	18.60	
78127-1389	78127-0389	38	32.00	28.40	14.20	21.40	19.10	
78127-1399	78127-0399	39	44.00	40.40	20.20	21.90	19.60	
78127-1409	78127-0409	40	44.00	40.40	20.20	22.40	20.10	

REVISED EC NO: J2013-0629 DRWN: MORISHITA 2012/11/30 CHYD: KAKAHASHI 2012/11/30 APPR: KMORIKAWA 2012/12/11	QUALITY SYMBOLS $\nabla_A = 0$ $\nabla_B = 0$ $\nabla_C = 0$	GENERAL TOLERANCES (UNLESS SPECIFIED)		DIMENSION STYLE MM ONLY		SCALE NTS	DESIGN UNITS METRIC	THIRD ANGLE PROJECTION		
			mm	INCH	DRAWN BY YLQ1A0	DATE 2006/05/05	TITLE 0.50MM PITCH, FPC CONN. NON-ZIF, SMT			
		4 PLACES 3 PLACES 2 PLACES 1 PLACES 0 PLACE	\pm --- \pm --- \pm 0.15 \pm --- \pm	\pm --- \pm --- \pm --- \pm --- \pm	CHECKED BY BOKOK	DATE 2006/06/06				
			ANGULAR $\pm 3^\circ$		MATERIAL NO. SEE TABLE	DATE 2006/06/06	DOCUMENT NO. SD-78127-001			
	DRAFT WHERE APPLICABLE MUST REMAIN WITHIN DIMENSIONS		SIZE A3	THIS DRAWING CONTAINS INFORMATION THAT IS PROPRIETARY TO MOLEX INCORPORATED AND SHOULD NOT BE USED WITHOUT WRITTEN PERMISSION						

10 9 8 7 6 5 4 3 2 1

F

E

D

C

B

A

F

E

D

C

B

A

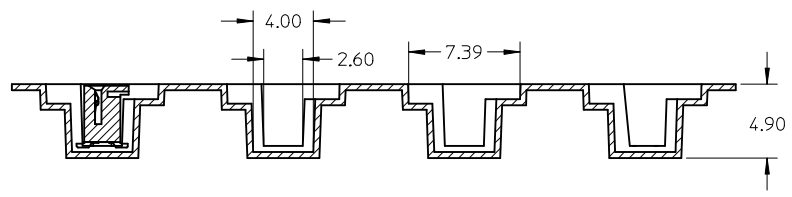
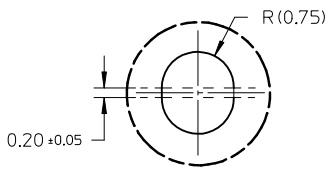
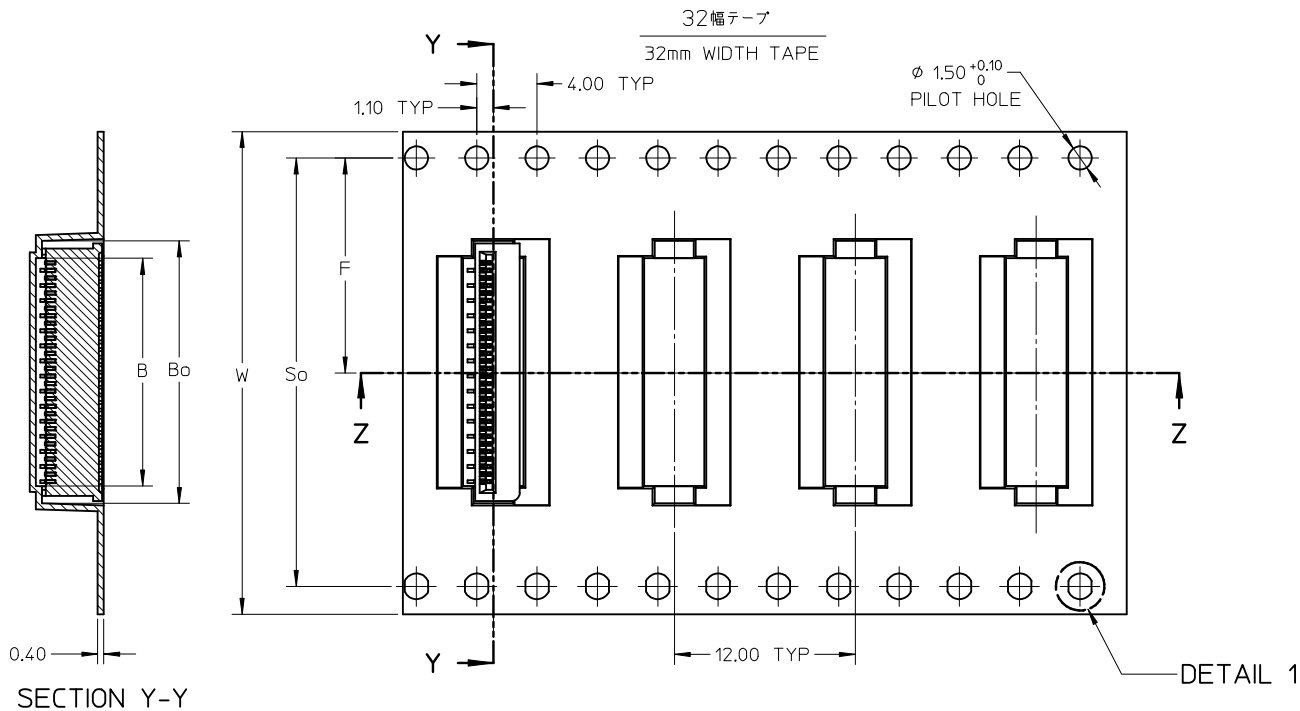
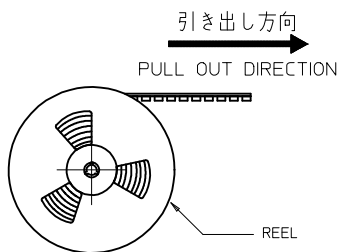

RELEASED EC NO: J2014-1840 DRW: NKONDO 2014/09/16 CHK: KTAKAHASHI 2014/09/16 APPR: YNOGAWA 2014/11/10	GENERAL TOLERANCES (UNLESS SPECIFIED)		DIMENSION STYLE MM ONLY		SCALE 1:1	DESIGN UNITS METRIC	THIRD ANGLE PROJECTION	
	10 UNDER	± 0.15	DRAWN BY NKONDO	DATE 2014/09/16	TITLE 0.50MM PITCH, FPC CONN. NON-ZIF, SMT EMBOSSSED TAPE PACKAGE			
	10 OVER 30 UNDER	± 0.15	CHECKED BY KTAKAHASHI	DATE 2014/09/16				
	30 OVER	± 0.15	APPROVED BY YNOGAWA	DATE 2014/11/10	molex DOCUMENT NO. SD-78127-003 SHEET NO. 1 OF 2			
	ANGULAR ±3 °		MATERIAL NO. SEE CHART					
DRAFT WHERE APPLICABLE MUST REMAIN WITHIN DIMENSIONS		SIZE A3		THIS DRAWING CONTAINS INFORMATION THAT IS PROPRIETARY TO MOLEX INCORPORATED AND SHOULD NOT BE USED WITHOUT WRITTEN PERMISSION				

9 8 7 6 5 4 3 2

NOTES

1. リードテープ長さ
LEAD TAPE LENGTH

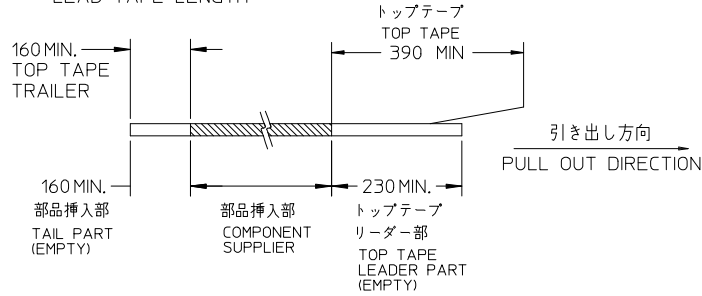

2. トップテープの剥離強度については、IEC60286-3に準拠
Cover tape peel force is defined by IEC60286-3.
3. 梱包数量 : 1000 個/リール
NUMBER OF CONNECTORS = 1000 PCS/REEL

32.00	28.40	14.20	20.40	18.10	78127-8736	78127-8636	36
32.00	28.40	14.20	18.40	16.10	78127-8732	78127-8632	32
32.00	28.40	14.20	17.40	15.10	78127-8730	78127-8630	30
32.00	28.40	14.20	16.40	14.10	78127-8728	78127-8628	28
32.00	28.40	14.20	14.40	12.10	78127-8724	78127-8624	24
32.00	28.40	14.20	13.40	11.10	78127-8722	78127-8622	22
32.00	28.40	14.20	12.40	10.10	78127-8720	78127-8620	20
32.00	28.40	14.20	8.40	6.10	78127-8712	78127-8612	12
TAPE WIDE(W)	So	F	Bo	B	CONNECTOR	MATERIAL NO.	CKT
						MODEL NO. : 78127-86**	

RELEASED EC NO: J2014-1840 DRWN: NKONDO 2014/09/16 CHKD: TAKAHASHI 2014/09/16 APPR: YNOGAWA 2014/11/10	DESCRIPTION GENERAL TOLERANCES (UNLESS SPECIFIED) DIMENSION STYLE MM ONLY SCALE 10:1 DESIGN UNITS METRIC THIRD ANGLE PROJECTION	10 UNDER	± 0.15	DRAWN BY NKONDO	DATE 2014/09/16	TITLE 0.50MM PITCH, FPC CONN. NON-ZIF, SMT EMBOSSED TAPE PACKAGE molex DOCUMENT NO. SD-78127-003 SHEET NO. 2 OF 2
		10 OVER 30 UNDER	± 0.15	CHECKED BY KTAKAHASHI	DATE 2014/09/16	
		30 OVER	± 0.15	APPROVED BY YNOGAWA	DATE 2014/11/10	
		ANGULAR ± 3 °		MATERIAL NO. SEE CHART		
DRAFT WHERE APPLICABLE MUST REMAIN WITHIN DIMENSIONS		THIS DRAWING CONTAINS INFORMATION THAT IS PROPRIETARY TO MOLEX INCORPORATED AND SHOULD NOT BE USED WITHOUT WRITTEN PERMISSION				