



AT-1000

**Advanced Wire
Tracer**

Users Manual



AT-1000

Advanced Wire Tracer

Users Manual

English

AT1000_Rev001
© 2008 Amprobe Test Tools.
All rights reserved.

Limited Warranty and Limitation of Liability

Your Amprobe product will be free from defects in material and workmanship for 2 years from the date of purchase. This warranty does not cover fuses, disposable batteries or damage from accident, neglect, misuse, alteration, contamination, or abnormal conditions of operation or handling. Resellers are not authorized to extend any other warranty on Amprobe's behalf. To obtain service during the warranty period, return the product with proof of purchase to an authorized Amprobe Test Tools Service Center or to an Amprobe dealer or distributor. See Repair Section for details. **THIS WARRANTY IS YOUR ONLY REMEDY. ALL OTHER WARRANTIES - WHETHER EXPRESS, IMPLIED OR STATUTORY - INCLUDING IMPLIED WARRANTIES OF FITNESS FOR A PARTICULAR PURPOSE OR MERCHANTABILITY, ARE HEREBY DISCLAIMED. MANUFACTURER SHALL NOT BE LIABLE FOR ANY SPECIAL, INDIRECT, INCIDENTAL OR CONSEQUENTIAL DAMAGES OR LOSSES, ARISING FROM ANY CAUSE OR THEORY.** Since some states or countries do not allow the exclusion or limitation of an implied warranty or of incidental or consequential damages, this limitation of liability may not apply to you.

Repair

All test tools returned for warranty or non-warranty repair or for calibration should be accompanied by the following: your name, company's name, address, telephone number, and proof of purchase. Additionally, please include a brief description of the problem or the service requested and include the test leads with the meter. Non-warranty repair or replacement charges should be remitted in the form of a check, a money order, credit card with expiration date, or a purchase order made payable to Amprobe® Test Tools.

In-Warranty Repairs and Replacement – All Countries

Please read the warranty statement and check your battery before requesting repair. During the warranty period any defective test tool can be returned to your Amprobe® Test Tools distributor for an exchange for the same or like product. Please check the "Where to Buy" section on www.amprobe.com for a list of distributors near you. Additionally, in the United States and Canada In-Warranty repair and replacement units can also be sent to a Amprobe® Test Tools Service Center (see address below).

Non-Warranty Repairs and Replacement – US and Canada

Non-warranty repairs in the United States and Canada should be sent to a Amprobe® Test Tools Service Center. Call Amprobe® Test Tools or inquire at your point of purchase for current repair and replacement rates.

In USA

Amprobe Test Tools
Everett, WA 98203
Tel: 877-AMPROBE (267-7623)

In Canada

Amprobe Test Tools
Mississauga, ON L4Z 1X9
Tel: 905-890-7600





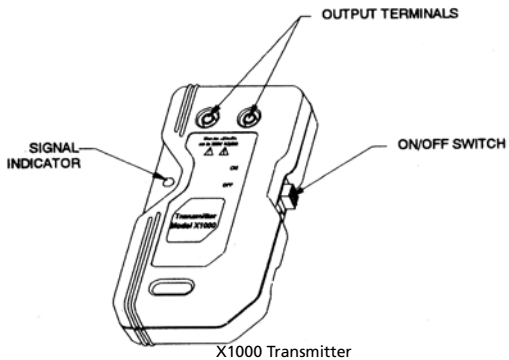
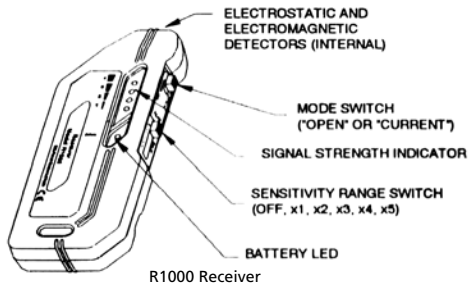







Non-Warranty Repairs and Replacement – Europe

European non-warranty units can be replaced by your Amprobe® Test Tools distributor for a nominal charge. Please check the "Where to Buy" section on www.amprobe.com for a list of distributors near you.



Symbols.....	5
Introduction.....	5
Safety Precautions and Warnings	5
Unpacking and inspection.....	6
Component Description.....	6
R1000 Receiver.....	6
X1000 Transmitter.....	6
Replacing Batteries: R1000 and X1000	7
Operation	7
Tracing Energized Wires	7
Locating Opens.....	8
Locating Shorts.....	8
Fuse Replacement	8
Specifications.....	9

SYMBOLS

	Battery		Refer to the manual
	Double insulated		Dangerous Voltage
	Direct Current		Earth Ground
	Alternating Current		Audible tone
	Conforms to relevant Australian standards.		Complies with EU directives
	Do not dispose of this product as unsorted municipal waste.		Underwriters Laboratories.
	Application around and removal from hazardous live conductors is permitted		

INTRODUCTION

AMPROBE is dedicated to designing, manufacturing and marketing high quality, reliable instruments for the skilled professional. AMPROBE has a history of providing safe, reliable equipment to trace energized wires, circuit breakers, tracing deenergized wires, and locating opens. The AT-1000 Advanced Tracing System combines these features in one versatile tool and is effective in solving most tracing problems.

The AT-1000 is a troubleshooting tool. An experienced troubleshooter will understand how the system to be traced works under normal conditions, and be familiar with the types of malfunctions that can exist. A thorough understanding of "Ohms Law" is helpful. It is a good idea to test the circuit for parameters such as Volts, Ohms, and Current to determine whether the circuit is "shorted", "semi-shortened", or "open", before attempting to trace. The characteristics of these malfunctions will designate which components, and tracing method, will be most effective in locating these malfunctions.

A thorough understanding of the operation and function of each of the AT-1000 components is essential. Overall, this knowledge could mean the difference between spending several minutes or several hours on a job. Pay special attention to the "Safety Precautions and Warnings". Experiment under known conditions. You will gain the confidence to use it on a daily basis and solve problems which were previously unsolvable.

SAFETY PRECAUTIONS AND WARNINGS

1. Read this manual in its entirety before proceeding with any testing.

2. This equipment should only be used by trained professionals who are familiar with electrical hazards.
3. Wear lineman gloves, safety glasses, and protective clothing at all times.
4. Do not attempt to replace or remove the battery in the X1000 Transmitter until X1000 is removed from the circuit and the cord set test leads are removed from the X1000 transmitter.
5. Always inspect the components and accessories for damage and proper operation BEFORE using. Replace any damaged components.
6. Before connecting the X1000 Transmitter to a circuit, verify that the voltage, at the intended point of contact, does not exceed 300VAC/DC.
7. Store the components in the case when not in use.
8. Remove the battery from the R1000 Receiver and X1000 Transmitter if the components will not be in use for a long period of time.
9. Before proceeding with any testing, confirm the X1000 is functioning correctly by switching the X1000 to the "ON" position. The Battery Indicator should flash. If the Battery Indicator remains "OFF", replace the battery.
10. Connections to the test circuit should be made after insertion of test leads into X1000.

UNPACKING AND INSPECTION

AT-1000 (US version)

1 x R1000 Receiver
 1 x X1000 Transmitter
 1 x C2901 Cordset
 1 x C2902 Cordset
 1 x AD-1 Adapter
 1x Instruction Manual
 1x Soft Carrying case
 2 x 9V Battery

AT-1000E (Europe version)

1 x R1000 Receiver
 1 x X1000 Transmitter
 2 x Test probes (in set EU-200)
 2 x Crocodile clips (in set EU-200)
 2 x Test leads (in set EU-200)
 1 x. Instruction Manual
 1 x Hard carrying case
 2 x 9V Battery

COMPONENT DESCRIPTION

R1000 Receiver

The R1000 contains two built-in detectors that are tuned to pick-up the 17kHz signal generated by the X1000. The detector is selected by the MODE Switch. The "OPEN" position selects the electrostatic (voltage potential) detector. The "CURRENT" position selects the electromagnetic (current) detector. The selection of detector depends on the condition of the circuit to be traced. The electromagnetic detector is set in one direction within the R1000 housing. The manner in which the receiver is held, and the direction in which the detector is pointed, will vary the amount of signal that is displayed and give the user an indication of the direction of the wire being traced. This is particularly evident when the R1000 is in the "CURRENT" MODE. Pointing the receiver perpendicular to the wire, so that the front label faces the direction of the wire, will yield the maximum signal displayed.

The R1000 is designed to display the signal strength visually with a series of four LED's, and audibly by emitting a pulsed tone. The R1000 is turned "ON" and "OFF", as well as varying the amount of signal strength that is displayed, by the Sensitivity Range Switch (OFF, X1, X2, X3, X4, X5). The Battery LED illuminates when the R1000 is turned ON. The distance the R1000 is held from the wire carrying the signal will also vary the signal strength that is displayed. The receiver can typically detect a signal approximately 1-3 feet away from the wire carrying the signal. Always try to keep the sensitivity low enough, or high enough, to maintain a maximum of 3 LED's on the indicator so the wire that is carrying the maximum signal is easily identified.

The user must vary the sensitivity to what is considered an acceptable, usable level (usually 3 LED's), while holding the receiver in the proper direction, to locate the conductor that is carrying the signal and to identify its direction.

X1000 Transmitter

⚠ ⚠ Warning

X1000 – Do not connect to live circuits above 300VAC/DC!

The X1000 Transmitter enables tracing of energized circuits up to 300VAC/DC as well as tracing deenergized lines.

When connected to a closed or energized circuit that allows current to flow, the X1000 will turn on and off and cause a 17kHz **current** fluctuation that can be detected, by the R1000 in the "CURRENT" mode, along the circuit path. The signal will flow to the lowest impedance in the circuit. Usually, the signal is more evident and detected on the conductors going back to the source (transformer). To increase the signal current travelling to the source (transformer), disconnect any known loads on that circuit.

When connected to an open circuit, the X1000 will inject a 17kHz **voltage** fluctuation that can be detected, by the R1000 in the "OPEN" mode, along the circuit path to the end of that circuit. Proper operation of the X1000 Transmitter is confirmed when the R1000 received indicates a pulsed signal.

REPLACING BATTERIES: R1000 AND X1000 (see Fig. 1)

⚠ ⚠ Warning

Do not attempt to replace or remove the battery in the X1000 Transmitter until X1000 is removed from the circuit and the cord set test leads are removed from the X1000 Transmitter.

The patented battery compartment, on the back of the R1000 and X1000, allows you to replace the battery quickly and easily. Two holes on the bottom of the compartment accept the round terminals of a 9 volt battery. The compartment is designed to accept the battery in only one orientation, so if the door doesn't close, turn the battery 180° and try again.

OPERATION

⚠ ⚠ Warning

Make sure the line voltage DOES NOT EXCEED the range of the X1000: 300VAC/DC max.

1. Using either the C2901 Pigtail Cords Set for 120V receptacles (see Fig. 2), or the C2902 Alligator-Clip Banana Plug Cord Set (see Fig. 3), connect the X1000 Transmitter to the circuit

(see Fig. 4). When using the C2902, always connect to ground first and disconnect from ground last.

2. Switch the R1000 Receiver "ON" by sliding the Sensitivity Range Switch" to position 3 and set the R1000 Mode Switch to "CURRENT MODE".
3. Verify that the X1000 Transmitter is generating a current signal by placing the R1000 tip against one of the cord set leads.
4. Go to the panel and move the Receiver up and down, and in front of, each circuit breaker to determine which one has the strongest signal. Remember to keep the receiver perpendicular to the breakers. Reduce the R1000 sensitivity with the "Sensitivity Range Switch" if the signal strength goes above 4 LED's. Leave it in this position until you come across another breaker with a stronger signal. The strongest signal will determine the proper breaker.
5. If two or more breakers produce the same signal strength indication, reduce the sensitivity or pull back the R1000 slightly from the breakers until detecting the right one.

TRACING ENERGIZED WIRES

⚠ ⚠ Warning

Make sure the line voltage does not exceed the range of the X1000 Transmitter: 300VAC/DC max.

The X1000 Transmitter produces opposing signals on each output terminal. When the conductors that are connected to these terminals come within close proximity of each other, the signal strength is attenuated (see Fig. 5).

This can make tracing conductors more difficult, if not impossible. In most cases you can solve this problem by using the C2902 cord set and connecting one output terminal to a different signal return path. Use something other than the return (neutral) running adjacent to the conductor you are trying to trace, like a water pipe or a ground rod. The AD-1 adapter enables access to the hot conductor in 120VAC receptacles (see Fig. 6).

1. Connect the X1000 Transmitter as in Fig. 6 and turn the unit "ON".
2. Set the R1000 Mode Switch to the "CURRENT " MODE.
3. Switch the R1000 Receiver "ON" by sliding the "Sensitivity Range Switch" set to position 5.
4. Verify that the X1000 Transmitter is generating a current signal by placing the tip against one of the cord set leads.
5. Move the R1000 Receiver along the conductor path, perpendicular to the conductor, and adjust the "Sensitivity Range" as needed to maintain approximately 3-4 LED's of signal strength.
6. Proceed to trace the wire by moving the R1000 left to right over the path of the wire so that you can see the rise and fall of the signal level (see Fig. 7). The strongest signal confirms the path of the wire. If the signal drops off, the wire may have taken a turn in another direction. Before attempting to adjust the sensitivity, back track and try tracing from another angle, if possible. If the signal becomes too strong, adjust the sensitivity as necessary.

LOCATING OPENS

“Opens” are deenergized conductors that are not connected to a source or a load, and therefore do not pass current. First verify that the conductor is deenergized, using a voltmeter, then verify that it is open, with respect to ground and/or adjacent conductors, using an Ohmmeter.

1. Using the C2902 Cord Set, connect the X1000 Transmitter to the open conductor and a separate ground as shown in Fig. 8. Use the AD-1 if applicable.
2. Where possible, ground any other conductors sharing the same path as the open wire to reduce capacitive coupling, or “signal bleed-off” onto those conductors.
3. Switch the R1000 Receiver to the “OPEN” mode and turn the receiver “ON” by sliding the “Sensitivity Range Switch” and set it to position 5.
4. Verify that the X1000 Transmitter is generating a signal by placing the R1000 tip against one of the cord set leads.
5. Proceed to trace the wire by moving the R1000 left to right over the path of the wire so that you can see the rise and fall of the signal level (see Fig. 7). Adjust the “Sensitivity Range Switch” to display 3 LED’s of signal strength. The strongest signal confirms the path of the wire. If the signal drops off, the wire may have taken a turn in another direction, or may be open at this point. Before attempting to adjust the sensitivity, back track and try tracing from another angle, if possible. Pinpoint the location of the open (where the signal drops off) by reducing the sensitivity while decreasing the distance between the R1000 and the conductor.
6. If possible, repeat the process starting from the other end of the wire to verify the location of the open.

LOCATING SHORTS

1. Using the C2902 Cord Set, connect the X1000 Transmitter to the shorted conductor and a separate ground as shown in Fig. 9. Use the AD-1 adapter if tracing a conductor connected to a receptacle.
2. Switch the R1000 Receiver to the “CURRENT” mode and turn the receiver “ON” by sliding the “Sensitivity Range Switch” and set it to position 5
3. Verify that the X1000 Transmitter is generating a signal by placing the R1000 tip against one of the cord set leads.
4. Proceed to trace the wire by moving the R1000 left to right over the path of the wire so that you can see the rise and fall of the signal level (see Fig. 7). Adjust the “Sensitivity Range Switch” to display 3 LED’s of signal strength. The strongest signal confirms the path of the wire. If the signal drops off, the wire may have taken a turn in another direction, or may be shorted at this point. Before attempting to adjust the sensitivity, back track and try tracing from another angle, if possible. Pinpoint the location of the short (where the signal drops off) by reducing the sensitivity while decreasing the distance between the R1000 and the conductor.
5. If possible, repeat the process starting from the other end of the wire to verify the location of the short.

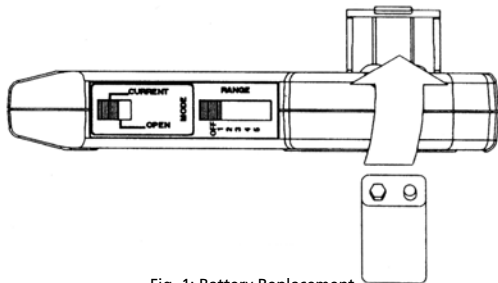

Fig. 1: Battery Replacement

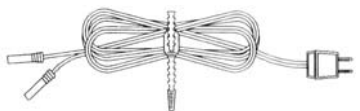

Fig. 2a: C2901 Cordset

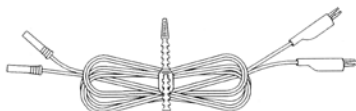

Fig. 2b: C2902 Cordset



Fig. 3: EU-200 Cordset

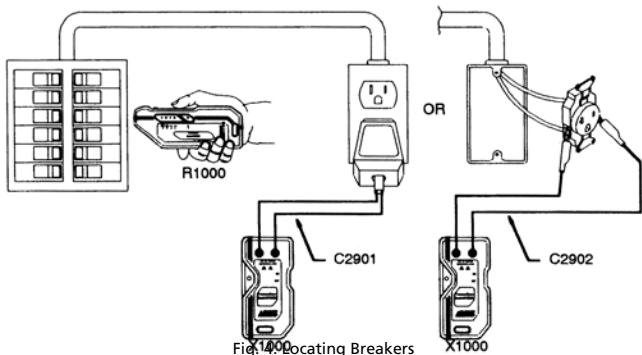

Fig. 4: Locating Breakers

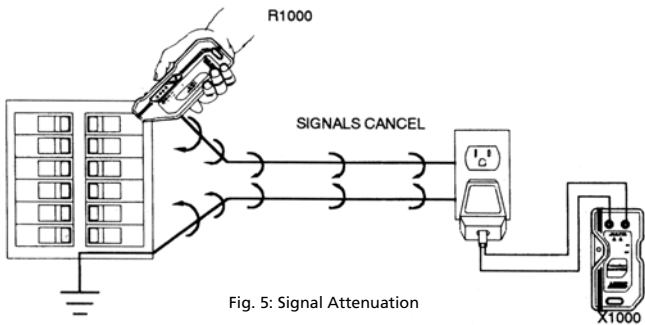
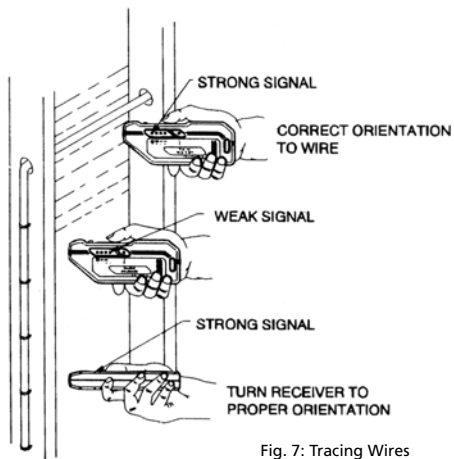
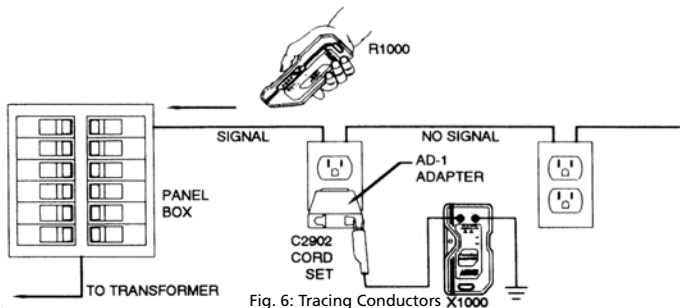

Fig. 5: Signal Attenuation



In the "Current Mode", orient the Receiver so that it is perpendicular to the wire.

Example:

Horizontal wire - The Sensitivity Range switch should face up.

Vertical wire - The Sensitivity Range switch should face either left or right.

Fig. 7: Tracing Wires

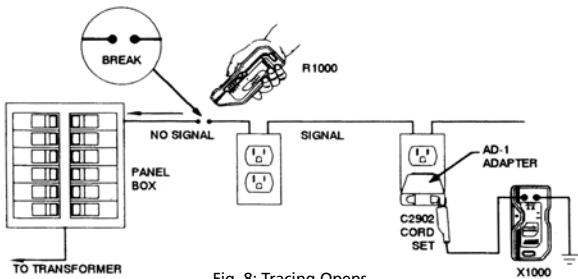
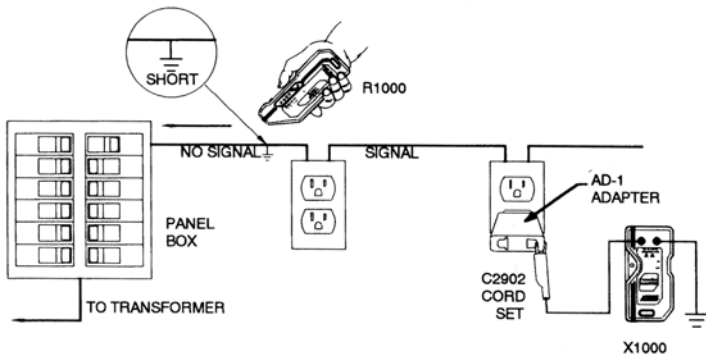

Fig. 8: Tracing Opens



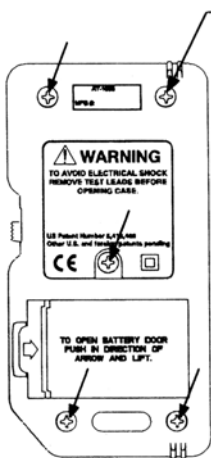

Fig. 10a: Back View

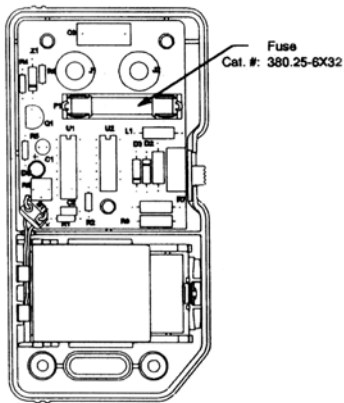

Fig. 10b: X1000 with Front Cover Removed

Fig. 10: Fuse Replacement

Visit www.Amprobe.com for

- Catalog
- Application notes
- Product specifications
- User manuals



Please Recycle

Mouser Electronics

Authorized Distributor

Click to View Pricing, Inventory, Delivery & Lifecycle Information:

[AMPROBE:](#)

[AT-1000](#)