



EasySYNC Ltd

ES-R-2x01B-M

RS-232 to RS-422/RS-485

Converters Manual

Document Reference No.: ES_000086

Version 1.0

Issue Date: 2011-08-24

The EasySYNC ES-R-2001B-M and ES-R-2101B-M are used to convert RS-232 signals to RS-422/RS-485 signals. The converters provide instant connectivity to RS-422/RS-485 communication devices for factory automation equipment, multi-drop data collection devices, barcode readers, time clocks, scales, data entry terminals, PC to PC long distance communications (up to 1.3KM) and serial communication in harsh environments.

This manual covers the following products:

- ES-R-2001B-M
- ES-R-2101B-M

Use of EasySYNC devices in life support and/or safety applications is entirely at the user's risk, and the user agrees to defend, indemnify and hold harmless EasySYNC from any and all damages, claims, suits or expense resulting from such use.

1	Introduction	3
2	Specification	4
3	Features of the ES-R-2x01B-M	5
3.1	Optical Isolation & Surge Protection (ES-R-2101B-M only).....	5
3.2	Power Supply	5
3.3	Enclosure	5
3.4	Configuring for RS-422 and RS-485 Modes	5
4	Hardware Installation.....	6
4.1	General Notes and Warnings.....	6
4.2	RS-232 DCE or DTE Pin Assignment	7
Table 1	Jumper settings for RS-232 DCE or DTE Pin Assignment	7
4.3	RS-422 and RS-485 Mode Block Configuration	7
Table 2	RS-422 and RS-485 configuration	7
4.4	Termination and Biasing Configuration	8
Table 3	Termination and Biasing configuration.....	8
5	Connector Pinout Information	9
5.1	RS-232 Signal Pin-outs of DB-9 Female (DCE)	9
5.2	RS-232 Signal Pin-outs of DB-9 Female (DTE)	9
5.3	RS-422 Signal Pin-out	10
5.4	RS-485 Signal Pin-out (half duplex).....	12
5.5	RS-485 Signal Pin-out (full duplex)	14
6	Contact Information	16
7	Legal Disclaimer	17
	Appendix A - List of Figures and Tables	18
	Appendix B - Revision History.....	19

1 Introduction

The EasySYNC ES-R-2001B-M and ES-R-2101B-M are used to convert RS-232 signals to RS-422/RS-485 signals. The converters provide instant connectivity to RS-422/RS-485 communication devices for factory automation equipment, multi-drop data collection devices, barcode readers, time clocks, scales, data entry terminals, PC to PC long distance communications (up to 1.3KM) and serial communication in harsh environments.

The ES-R-2001B-M and ES-R-2101B-M provide an industrial solution for applications requiring single node or multi-drop communications over short or long distances.

In RS-485 half-duplex mode, the ES-R-2001B-M and ES-R-2101B-M also provide automatic data transmit/receive control.

This user guide covers the following models:

- RS-232 to RS-422/RS-485 Converter (ES-R-2001B-M)
- Opto-isolated RS-232 to RS-422/RS-485 Converter (ES-R-2101B-M)

2 Specification

RS-232 to RS-422/RS-485 Converter (ES-R-2001B-M)

- Converts RS-232 port to high speed RS-422 / RS-485 port
- RS-232 port can be selected to DCE or DTE pin assignment
- Data rate: 300 bps to 1M bps
- RS-232 connector: One DB-9 female connector
- RS-422 / RS-485 connector: One DB-9 male connector and one 5-pin terminal block
- Auto transmit/receive control for 2-wire RS-485 half-duplex operation
- Termination and bias resistors installed on-board and selectable by jumpers
- RS-422 data signals : TX-, TX+, RX+, RX-, GND, RTS-, RTS+, CTS+, CTS-
- RS-485 data signals (full-duplex) : TX-, TX+, RX+, RX-, GND
- RS-485 data signals (half-duplex) : Data-, Data+, GND
- LEDs indicate TxD and RxD
- Wide input power range : 9V DC to 48V DC

Opto-isolated RS-232 to RS-422/RS-485 Converter (ES-R-2101B-M)

- Converts RS-232 port to high speed RS-422 / RS-485 port
- RS-232 port can be selected to DCE or DTE pin assignment
- RS-422/RS-485 port is optically isolated with 2000 Volt DC optical isolation
- RS-422/RS-485 port is surge protected on all signal lines to withstand electrostatic discharge and power surges up to 25KV ESD
- Data rate: 300 bps to 1M bps
- RS-232 connector: One DB-9 female connector
- RS-422 / RS-485 connector: One DB-9 male connector and one 5-pin terminal block
- Auto transmit/receive control for 2-wire RS-485 half-duplex operation
- Termination and bias resistors installed on-board and selectable by jumpers
- RS-422 data signals : TX-, TX+, RX+, RX-, GND, RTS-, RTS+, CTS+, CTS-
- RS-485 data signals (full-duplex) : TX-, TX+, RX+, RX-, GND
- RS-485 data signals (half-duplex) : Data-, Data+, GND
- LEDs indicate TxD and RxD
- Wide input power range : 9V DC to 48V DC

3 Features of the ES-R-2x01B-M

3.1 Optical Isolation & Surge Protection (ES-R-2101B-M only)

The ES-R-2101B-M converter is optically isolated with 2000 Volt DC optical isolation. The optical isolation protects the PC from spikes and surges on the RS-422/RS-485 network, by converting the electrical pulse into an optical signal and then changing it back into an electrical pulse. The computer is well protected, since the surges and spikes cannot cross the optical link.

The ES-R-2101B-M also features surge protectors, to withstand electrostatic discharge and power surges up to 25KV ESD. The surge suppression on all signals prevents damage caused by lightning or high voltage.

3.2 Power Supply

The ES-R-2001B-M and ES-R-2101B-M accept a wide range of supply voltages, from 9V DC to 48V DC. The power input connector is a 3-pin terminal-block style connector as shown in Figure 1 below.

An external switch-mode power adapter is supplied with the converter.

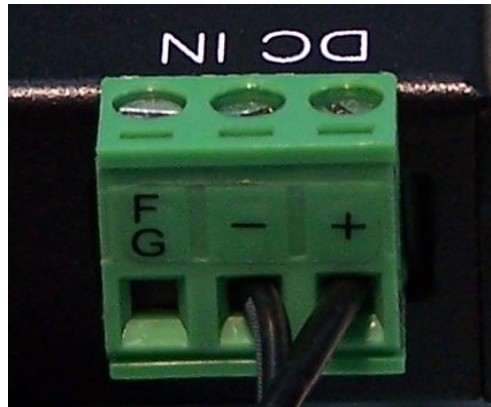

Figure 1 9V DC to 48V DC power input connector

3.3 Enclosure

The ES-R-2001B-M and ES-R-2101B-M converters have a metal enclosure. Transmit and Receive LEDs are included to show when data is being transmitted or received on the serial lines. A power LED is also included to show that the converter is receiving power.

3.4 Configuring for RS-422 and RS-485 Modes

The ES-R-2001B-M and ES-R-2101B-M converters use DIP switches to select RS-422 or RS-485 modes. They also feature jumpers to set the pinout of the RS-232 port to a DCE or DTE configuration, and to enable termination and biasing when required.

Please refer to section 4 for more information on the DIP switch and jumper settings available.

4 Hardware Installation

4.1 General Notes and Warnings

Serial Bus Configuration

It is important to configure the DIP switches and jumpers to select the correct type of serial bus (RS-422 or RS-485) for your application before connecting the ES-R-2x01B-M converter to your serial bus. Otherwise damage can occur to the converter or other equipment on the bus.

To avoid damage, the power supply and serial cables should be disconnected from your converter before changing DIP switch settings and before opening the case to change jumper settings.

Termination

For RS-422 or RS-485, it may be necessary to enable termination of the data transmission lines. This depends on the way in which your network is connected and if termination is already provided by other devices on the network. Before applying the termination, check your cable specification for proper impedance matching.

Termination is normally used in the node at each end of the bus, but nodes in the middle of the bus should not have termination enabled. The ES-R-2x01B-M converters have jumpers to allow internal termination resistors to be enabled if required. This avoids the need to provide an external resistor at the ES-R-2x01B-M end of the bus.

Since a computer controlled serial port is normally at one end of the cable, termination is enabled by default in the converter. If termination is not required, please disable this feature using the jumpers inside the converter.

ES-R-2x01B-M converters have jumpers for both Tx \pm termination and Rx \pm termination. When using RS-485 half-duplex, only the Tx \pm termination should be enabled.

Biasing

For RS-485 half-duplex, it may be necessary to enable biasing of the data transmission lines. In some cases, the RS-485 lines may float to undefined levels when no transmitter is active. This can cause additional unexpected characters to appear at the start or end of a message. Biasing resistors are used to guarantee a defined logic level on the serial lines when no node is transmitting.

The ES-R-2x01B-M models feature internal 750 ohm resistors with jumpers to enable/disable them. These should be disabled if another device on your serial bus already provides biasing as biasing of data lines must only occur at a single point in the cabling. They are typically not required in RS-422 and some RS-485 full-duplex applications since the transmitter is always enabled.

The ES-R-2x01B-M converters have four jumpers to select biasing on Tx+, Tx-, Rx+ and Rx-. For biasing of an RS-485 half-duplex bus, enable only the Rx biasing (*Pull-up Rx+ to VCC by 750 Ohm Bias resistor and Pull-down Rx- to GND by 750 Ohm Bias resistor*). The Tx biasing (*Pull-up Tx+ to VCC by 750 Ohm Bias resistor and Pull-down Tx- to GND by 750 Ohm Bias resistor*) should not be enabled as this would provide two biasing resistors per line.

4.2 RS-232 DCE or DTE Pin Assignment

Inside the unit, there are two 2x3 (JP1, JP2) header blocks which are jumpered to select the RS-232 port pin assignment to DCE or DTE. The factory default setting is DCE.

Jumper	Function
JP1 1-3 JP1 2-4 JP2 1-3 JP2 2-4	RS-232 port assigned to DCE (Data Communications Equipment). See Figure 2.
JP1 3-5 JP1 4-6 JP2 3-5 JP2 4-6	RS-232 port assigned to DTE (Data Terminal Equipment). See See Figure 2.

Table 1 Jumper settings for RS-232 DCE or DTE Pin Assignment

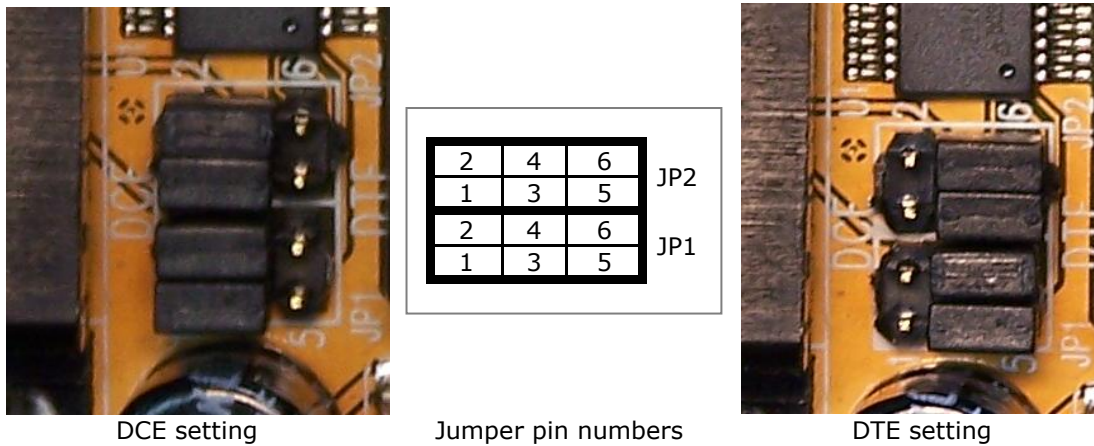

Figure 2 Jumpers used to select RS-232 DCE and DTE

4.3 RS-422 and RS-485 Mode Block Configuration

A 3-pin DIP switch is used to set to select the mode of operation. The switches should be set to RS-422 mode or RS-485 mode as per the requirements of your application.

The RS-422 & RS-485 Mode Block Configuration Settings are shown in Table 2.

	Operation Mode	S1	S2	S3
RS-422	4 wire with handshaking	ON	ON	ON
RS-485	Full Duplex (4 wire)	OFF	ON	ON
	Half Duplex (2 wire) with Echo	OFF	OFF	ON
	Half Duplex (2 wire) without Echo	OFF	OFF	OFF

Table 2 RS-422 and RS-485 configuration

4.4 Termination and Biasing Configuration

Inside the converter, there is a 7x3 (21pin) header block which has jumpers to enable the Tx, Rx and CTS 120 Ohm termination resistors, and the Tx and Rx 750 Ohm biasing resistors. Open the case and set the jumpers as per the requirements of your application. The settings are detailed below.

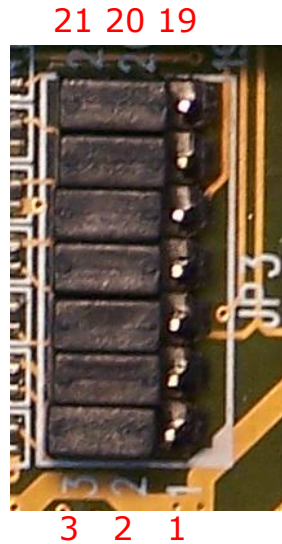

Figure 3 Setting termination and biasing resistors

Jumper	Function
1-2 enable	Tx± Termination of 120 Ohm.
2-3 disable	This function should be enabled for RS485 Half-Duplex mode.
4-5 enable	Pull-up Tx+ to VCC by 750 Ohm Bias resistor.
5-6 disable	This function should be enabled to pull-up Tx+.
7-8 enable	Pull-down Tx- to GND by 750 Ohm Bias resistor.
8-9 disable	This function should be enabled to pull-down Tx-.
10-11 enable	Rx± Termination of 120 Ohm.
11-12 disable	This function should be enabled for RS-422 and RS485 Full-Duplex mode.
13-14 enable	Pull-up Rx+ to VCC by 750 Ohm Bias resistor.
14-15 disable	This function should be enabled to pull-up Rx+.
16-17 enable	Pull-down Rx- to GND by 750 Ohm Bias resistor.
17-18 disable	This function should be enabled to pull-down Rx-.
19-20 enable	CTS Termination of 120 Ohm.
20-21 disable	This function should be enabled for RS-422 mode.

Note: See section 4.1 for further information before setting termination and biasing

Table 3 Termination and Biasing configuration

5 Connector Pinout Information

This section shows the connector pinouts used on the ES-R-2001B-M and ES-R-2101B-M converters. This allows the use of a straight-through cable between the host computer and the RS-232 port of the ES-R-2x01B-M.

5.1 RS-232 Signal Pin-outs of DB-9 Female (DCE)

Pin Number	Description
1	DCD = Data Carrier Detect
2	RXD = Receive Data
3	TXD = Transmit Data
4	DTR = Data Terminal Ready
5	GND = RS232 signal ground
6	DSR = Data Set Ready
7	RTS = Request To Send
8	CTS = Clear To Send
9	No Connect

Table 4 RS-232 Pin-Out for DB-9 connector (DCE)

5.2 RS-232 Signal Pin-outs of DB-9 Female (DTE)

Pin Number	Description
1	DCD = Data Carrier Detect
2	TXD = Transmit Data
3	RXD = Receive Data
4	DSR = Data Set Ready
5	GND = RS232 signal ground
6	DTR = Data Terminal Ready
7	CTS = Clear To Send
8	RTS = Request To Send
9	No Connect

Table 5 RS-232 Pin-Out for DB-9 connector (DTE)

5.3 RS-422 Signal Pin-out

DB-9 Male connector

The table below shows the RS-422 pin-out of the DB-9 Male connector.

Pin Number	Description
1	TxD- = Transmit data, negative polarity
2	TxD+ = Transmit data, positive polarity
3	RxD+ = Receive data, positive polarity
4	RxD- = Receive data, negative polarity
5	GND = Signal ground
6	RTS- = Request to send, negative polarity
7	RTS+ = Request to send, positive polarity
8	CTS+ = Clear to send , positive polarity
9	CTS- = Clear to send, negative polarity

Table 6 RS-422 Pin-Out for DB-9 connector

5-way Terminal Block

The table below shows the RS-422 pin-out of the 5-way terminal block.

Pin Number	Description
1	TxD- = Transmit data, negative polarity
2	TxD+ = Transmit data, positive polarity
3	RxD+ = Receive data, positive polarity
4	RxD- = Receive data, negative polarity
5	GND = Signal ground

Table 7 RS-422 Pin-Out for 5-way terminal block

Wiring diagrams

The following diagram shows an RS-422 full-duplex bus. The ES-R-2x01B-M converters have a built-in resistor for terminating their RxD \pm input, which can be enabled using a jumper. The Tx \pm lines which are outputs from the ES-R-2x01B-M are terminated at the receiver at the other end of the bus as shown. Twisted pair wires are required for each signal pair.

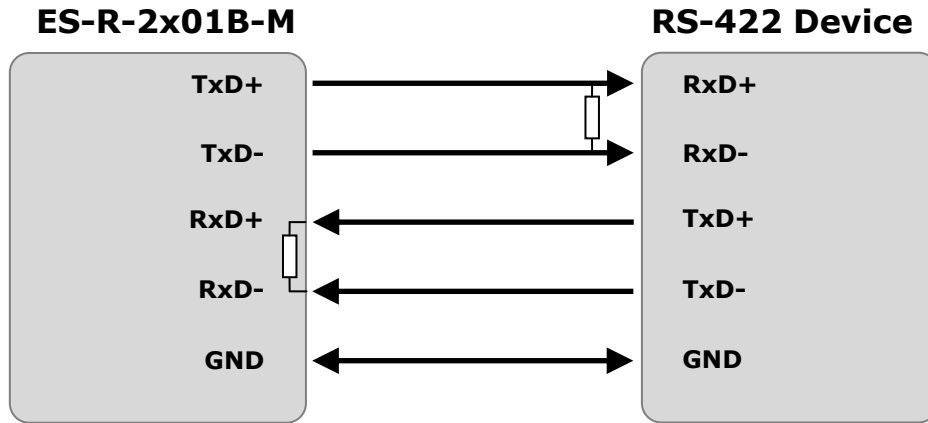

Figure 4 RS-422 4 Wire Full Duplex

The following diagram shows an RS-422 full-duplex bus with handshaking signals connected. The ES-R-2x01B-M converters have built-in resistors for terminating their RxD \pm and CTS \pm inputs, which can be enabled using jumpers. The TxD \pm and RTS \pm lines which are outputs from the ES-R-2x01B-M are terminated at the receiver at the other end of the bus as shown. Twisted pair wires are required for each signal pair.

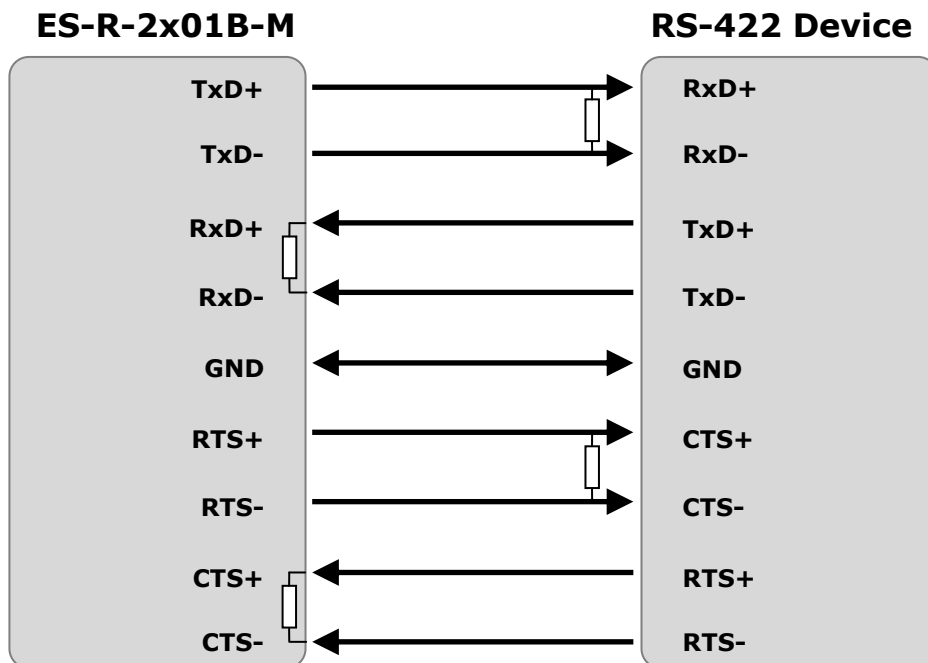

Figure 5 RS-422 with handshaking signals connected

5.4 RS-485 Signal Pin-out (half duplex)

DB-9 Male connector

The table below shows the RS-485 (half duplex) pinout of the DB-9 male connector.

Pin Number	Description
1	Data- = Transmit / Receive Data, negative polarity
2	Data+ = Transmit / Receive Data, positive polarity
5	GND = Signal ground

Note: Other pins have no function in this mode and should be left unconnected.

Table 8 RS-485 half-duplex pin-out for DB-9 connector

5-way Terminal Block

The table below shows the RS-485 (half duplex) pinout of the 5 way terminal block.

Pin Number	Description
1	Data- = Transmit / Receive Data, negative polarity
2	Data+ = Transmit / Receive Data, positive polarity
5	GND = Signal ground

Note: Other terminals have no function in this mode and should be left unconnected.

Table 9 RS-485 half-duplex pin-out for 5-way terminal block

Wiring Diagrams

The diagram shows an ES-R-2x01B-M converter connected to an RS-485 half-duplex bus. If the ES-R-2x01B-M is at one end of the bus (as shown), the built-in resistor can be enabled to terminate the Data \pm lines. The Tx \pm termination jumper is used to enable this resistor. A second termination resistor is fitted at the other end of the bus as shown.

If additional unexpected zero bytes are being received, the ES-R-2x01B-M converters also features bias resistors (not shown below) which can be enabled by enabling the *Pull-up Rx+ to VCC by 750 Ohm Bias resistor* and *Pull-down Rx- to GND by 750 Ohm Bias resistor* jumpers. For further details see sections 4.1 and 4.4. These should not be enabled if another device on the bus is already providing biasing. Twisted pair wires are required for each signal pair.

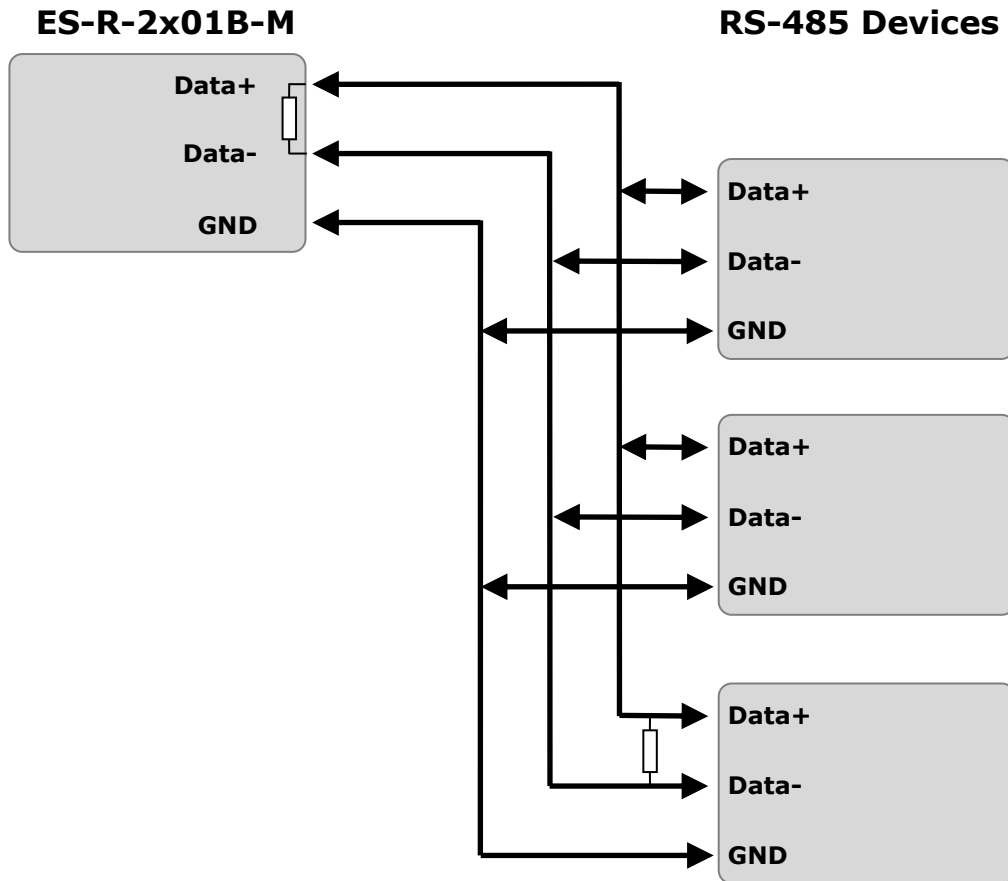

Figure 6 RS-485 Half Duplex Wiring

5.5 RS-485 Signal Pin-out (full duplex)

DB-9 Male connector

The table below shows the RS-485 (full duplex) pinout of the DB-9 male connector.

Pin Number	Description
1	TxD- = Transmit data, negative polarity
2	TxD+ = Transmit data, positive polarity
3	RxD+ = Receive data, positive polarity
4	RxD- = Receive data, negative polarity
5	GND = Signal ground

Note: Other pins have no function in this mode and should be left un-connected.

Table 10 RS-485 full duplex pin-out for DB-9 connector

5-way Terminal Block

The table below shows the RS-485 (full duplex) pinout of the 5 way terminal block.

Pin Number	Description
1	TxD- = Transmit data, negative polarity
2	TxD+ = Transmit data, positive polarity
3	RxD+ = Receive data, positive polarity
4	RxD- = Receive data, negative polarity
5	GND = Signal ground

Table 11 RS-485 full duplex pin-out for terminal block

Wiring Diagrams

The following diagram shows an RS-485 full-duplex bus. The ES-R-2x01B-M has a built-in resistor for terminating its RxD ± input, which can be enabled using a jumper. The Tx ± lines which are outputs from the ES-R-2x01B-M would be terminated at the receiver at the other end of the bus as shown. Twisted pair wires are required for each signal pair.

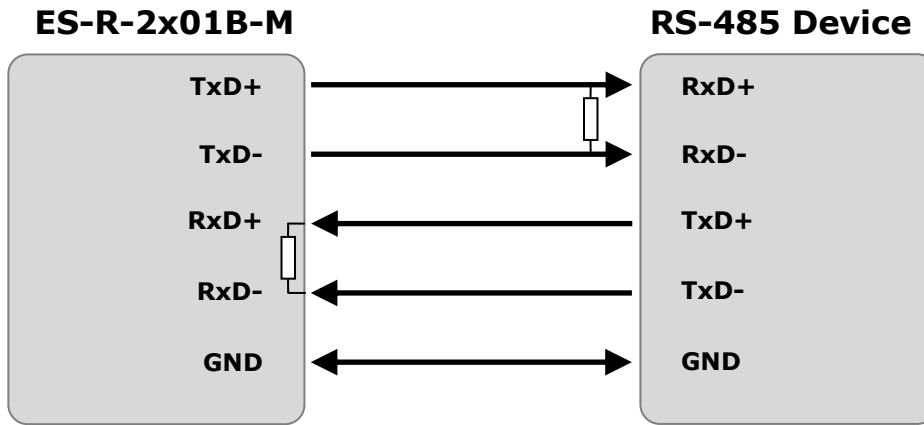

Figure 7 RS-485 Full Duplex Wiring

6 Contact Information

Head Office – Glasgow, UK

EasySYNC Limited
Unit 1, 2 Seaward Place,
Centurion Business Park
Glasgow, G41 1HH
United Kingdom
Tel: +44 (0) 141 418 0181
Fax: +44 (0) 141 418 0110

E-mail (Sales)	sales@easysync.co.uk
E-mail (Support)	support@easysync.co.uk
E-mail (General Enquiries)	admin@easysync.co.uk
Web Site URL	http://easysync-ltd.com
Web Shop URL	http://easysync-ltd.com

Branch Office – Hillsboro, Oregon, USA

EasySYNC Limited (USA)
7235 NW Evergreen Parkway, Suite 600
Hillsboro, OR 97123-5803
USA
Tel: +1 (503) 547 0909
Fax: +1 (503) 547 0990

E-Mail (Sales)	sales@easysync-ltd.com
E-Mail (Support)	support@easysync-ltd.com
E-Mail (General Inquiries)	admin@easysync-ltd.com
Web Site URL	http://easysync-ltd.com
Web Shop URL	http://easysync-ltd.com

7 Legal Disclaimer

System and equipment manufacturers and designers are responsible to ensure that their systems, and any EasySYNC devices incorporated in their systems, meet all applicable safety, regulatory and system-level performance requirements. All application-related information in this document (including application descriptions, suggested EasySYNC devices and other materials) is provided for reference only. While EasySYNC has taken care to assure it is accurate, this information is subject to customer confirmation, and EasySYNC disclaims all liability for system designs and for any applications assistance provided by EasySYNC. Use of EasySYNC devices in life support and/or safety applications is entirely at the user's risk, and the user agrees to defend, indemnify and hold harmless EasySYNC from any and all damages, claims, suits or expense resulting from such use. This document is subject to change without notice. No freedom to use patents or other intellectual property rights is implied by the publication of this document. Neither the whole nor any part of the information contained in, or the product described in this document, may be adapted or reproduced in any material or electronic form without the prior written consent of the copyright holder. EasySYNC Ltd, Unit 1, 2 Seaward Place, Centurion Business Park, Glasgow G41 1HH, United Kingdom. Scotland Registered Company Number: SC224924

Appendix A - List of Figures and Tables

List of Figures

Figure 1	9V DC to 48V DC power input connector	5
Figure 2	Jumpers used to select RS-232 DCE and DTE	7
Figure 4	RS-422 4 Wire Full Duplex	11
Figure 5	RS-422 with handshaking signals connected	11
Figure 6	RS-485 Half Duplex Wiring.....	13
Figure 7	RS-485 Full Duplex Wiring	15

List of Tables

Table 1	Jumper settings for RS-232 DCE or DTE Pin Assignment.....	7
Table 2	RS-422 and RS-485 configuration	7
Table 3	Termination and Biasing configuration.....	8
Table 4	RS-232 Pin-Out for DB-9 connector (DCE)	9
Table 5	RS-232 Pin-Out for DB-9 connector (DTE).....	9
Table 6	RS-422 Pin-Out for DB-9 connector.....	10
Table 7	RS-422 Pin-Out for 5-way terminal block.....	10
Table 8	RS-485 half-duplex pin-out for DB-9 connector	12
Table 9	RS-485 half-duplex pin-out for 5-way terminal block.....	12
Table 10	RS-485 full duplex pin-out for DB-9 connector.....	14
Table 11	RS-485 full duplex pin-out for terminal block	14

Appendix B - Revision History

Version 1.0 First Release

24th August 2011

Mouser Electronics

Authorized Distributor

Click to View Pricing, Inventory, Delivery & Lifecycle Information:

[EasySync:](#)

[ES-R-2001B-M](#) [ES-R-2101B-M](#)