

**SCHOTTKY BARRIER RECTIFIER**

**VOLTAGE RANGE 20 to 100 Volts CURRENT 1.0 Ampere**

**FEATURES**

- \* Low power loss, high efficiency
- \* Low leakage
- \* Low forward voltage
- \* High current capability
- \* High speed switching
- \* High surge capability
- \* High reliability

**MECHANICAL DATA**

- \* Case: Molded plastic
- \* Epoxy: Device has UL flammability classification 94V-0
- \* Lead: MIL-STD-202E method 208C guaranteed
- \* Mounting position: Any
- \* Weight: 0.12 gram

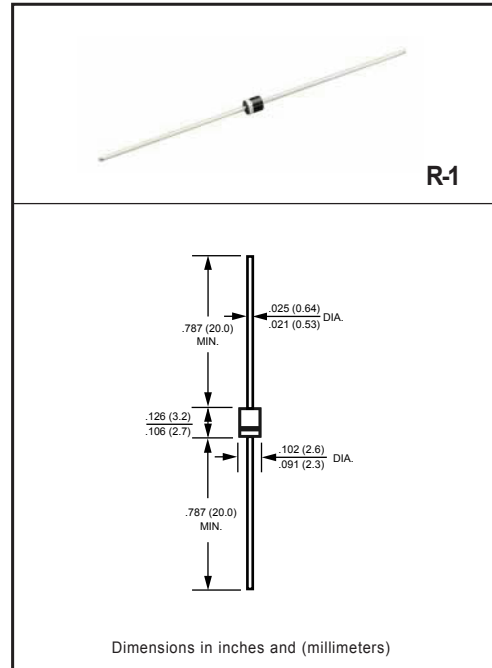

**MAXIMUM RATINGS AND ELECTRICAL CHARACTERISTICS**

Ratings at 25 °C ambient temperature unless otherwise specified.  
Single phase, half wave, 60 Hz, resistive or inductive load.  
For capacitive load, derate current by 20%.

**MAXIMUM RATINGS (@ TA=25 °C unless otherwise noted)**

RATINGS	SYMBOL	1S20	1S30	1S40	1S50	1S60	1S80	1S100	UNITS
Maximum Recurrent Peak Reverse Voltage	V <sub>RRM</sub>	20	30	40	50	60	80	100	Volts
Maximum RMS Voltage	V <sub>RMS</sub>	14	21	28	35	42	56	70	Volts
Maximum DC Blocking Voltage	V <sub>DC</sub>	20	30	40	50	60	80	100	Volts
Maximum Average Forward Rectified Current .375" (9.5mm) lead length	I <sub>O</sub>	1.0							Amps
Peak Forward Surge Current 8.3 ms single half sine-wave superimposed on rated load (JEDEC method)	I <sub>FSM</sub>	20							Amps
Typical Thermal Resistance (Note 3)	R <sub>θJA</sub>	60							°C/W
	R <sub>θJL</sub>	20							
Typical Junction Capacitance (Note 1)	C <sub>J</sub>	110							pF
Operating Temperature Range	T <sub>J</sub>	150							°C
Storage Temperature Range	T <sub>STG</sub>	-55 to + 150							°C

**ELECTRICAL CHARACTERISTICS (@TA=25 °C unless otherwise noted)**

CHARACTERISTICS	SYMBOL	1S20	1S30	1S40	1S50	1S60	1S80	1S100	UNITS
Maximum Instantaneous Forward Voltage at 1.0A DC	V <sub>F</sub>	.55			.70		.85		Volts
Maximum Average Reverse Current at Rated DC Blocking Voltage	@T <sub>A</sub> = 25°C	0.2							mAmps
	@T <sub>A</sub> = 100°C	10							mAmps

- NOTES : 1. Measured at 1 MHz and applied reverse voltage of 4.0 volts.  
2. "Fully ROHS compliant", "100% Sn plating (Pb-free)".  
3. Thermal Resistance : At 9.5mm lead lengths, PCB mounted.

## RATING AND CHARACTERISTICS CURVES ( 1S20 THRU 1S100 )

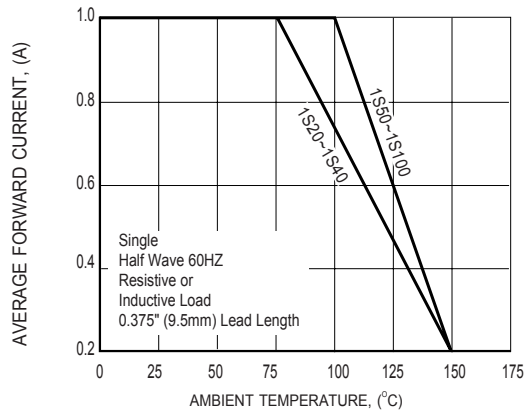

**FIG.1 TYPICAL FORWARD CURRENT DERATING CURVE**

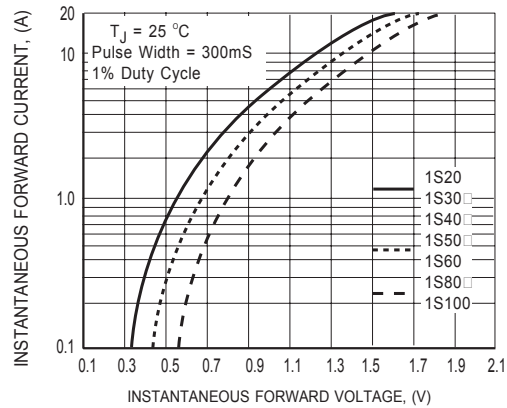

**FIG.2 TYPICAL INSTANTANEOUS FORWARD CHARACTERISTICS**

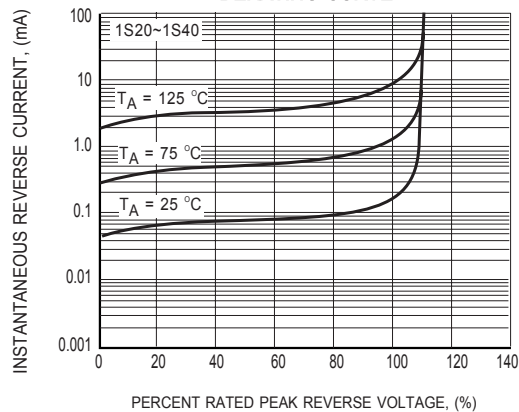

**FIG.3 TYPICAL REVERSE CHARACTERISTICS**

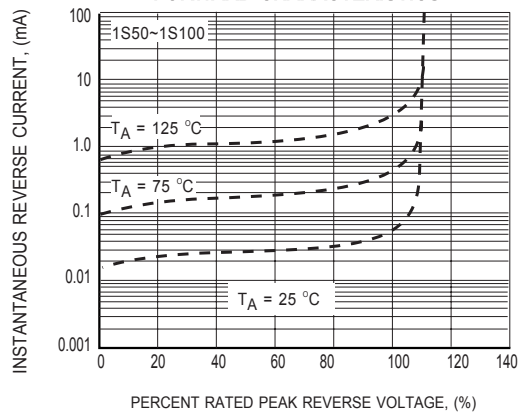

**FIG.3 TYPICAL REVERSE CHARACTERISTICS**

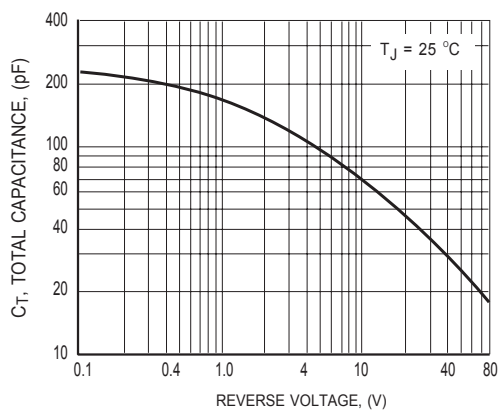

**FIG.4 TYPICAL JUNCTION CAPACITANCE**

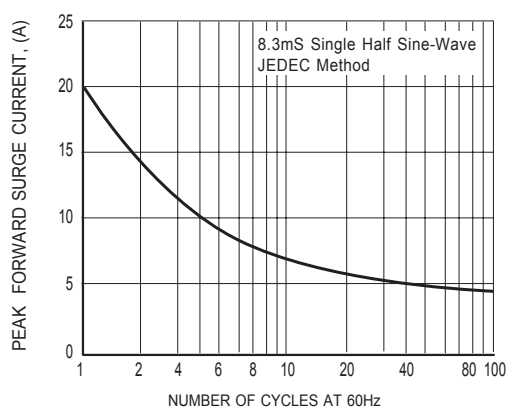

**FIG.5 MAXIMUM NON-REPETITIVE FORWARD SURGE CURRENT**

## DISCLAIMER NOTICE

Rectron Inc reserves the right to make changes without notice to any product specification herein, to make corrections, modifications, enhancements or other changes. Rectron Inc or anyone on its behalf assumes no responsibility or liability for any errors or inaccuracies. Data sheet specifications and its information contained are intended to provide a product description only. "Typical" parameters which may be included on RECTRON data sheets and/ or specifications can and do vary in different applications and actual performance may vary over time. Rectron Inc does not assume any liability arising out of the application or use of any product or circuit.

Rectron products are not designed, intended or authorized for use in medical, life-saving implant or other applications intended for life-sustaining or other related applications where a failure or malfunction of component or circuitry may directly or indirectly cause injury or threaten a life without expressed written approval of Rectron Inc. Customers using or selling Rectron components for use in such applications do so at their own risk and shall agree to fully indemnify Rectron Inc and its subsidiaries harmless against all claims, damages and expenditures.