

### Features

- \* Designed for ease in circuit board assembly.
- \* Black case enhance contrast ratio.
- \* Solid state light source.
- \* Reliable and rugged.

### Package Dimensions

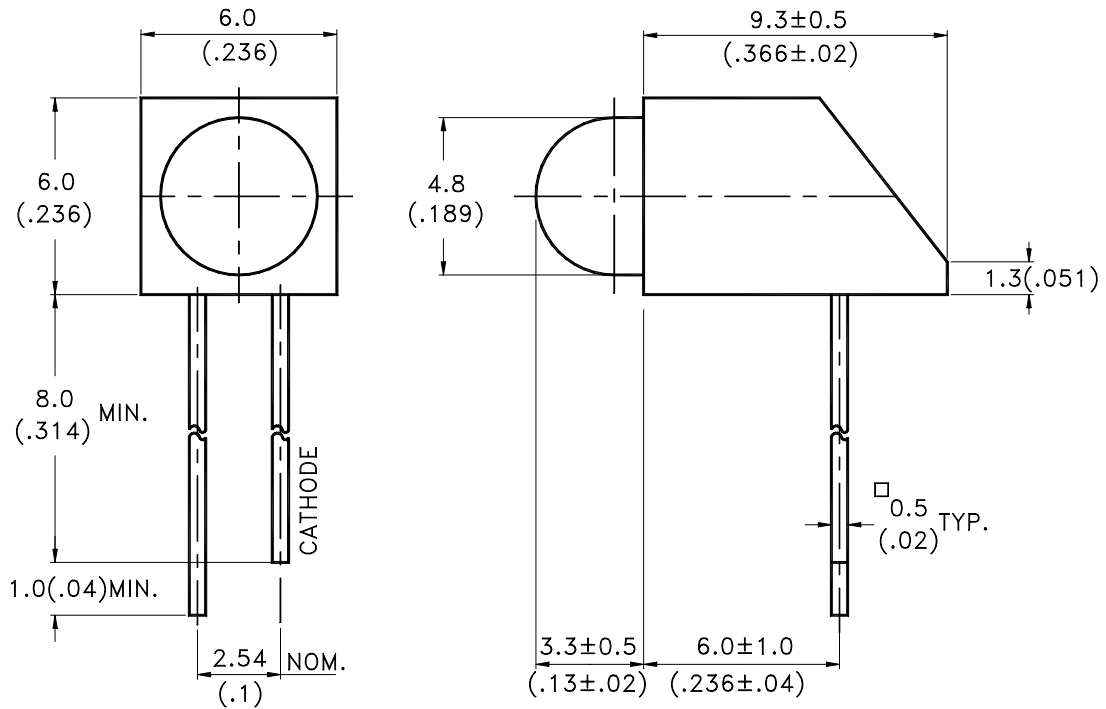

Lamp Part No.	Lens	Source Color
LTL-10233WP	Green Diffused	Green

#### Notes:

1. All dimensions are in millimeters (inches).
2. Tolerance is  $\pm 0.25\text{mm} (.010\text{'})$  unless otherwise noted.
3. The holder color is black.
4. The holder raw material is PC.
5. The LED lamp is LTL-10233WP.



# LITE-ON TECHNOLOGY CORPORATION

Property of Lite-On Only

## Absolute Maximum Ratings at $T_a=25^{\circ}\text{C}$

Parameter	Maximum Rating	Unit
Power Dissipation	100	mW
Peak Forward Current (1/10 Duty Cycle, 0.1ms Pulse Width)	120	mA
DC Forward Current	30	mA
Derating Linear From $50^{\circ}\text{C}$	0.4	$\text{mA}/^{\circ}\text{C}$
Reverse Voltage	5	V
Operating Temperature Range	$-55^{\circ}\text{C}$ to $+100^{\circ}\text{C}$	
Storage Temperature Range	$-55^{\circ}\text{C}$ to $+100^{\circ}\text{C}$	
Lead Soldering Temperature [1.6mm(.063") From Body]	$260^{\circ}\text{C}$ for 5 Seconds	

**Electrical Optical Characteristics at Ta=25°C**

Parameter	Symbol	Part No. LTL-	Min.	Typ.	Max.	Unit	Test Condition
Luminous Intensity	I <sub>v</sub>	533-11	12.6	40		mcd	I <sub>F</sub> = 10mA Note 1,4
Viewing Angle	2θ <sub>1/2</sub>	533-11		60		deg	Note 2 (Fig.6)
Peak Emission Wavelength	λ <sub>p</sub>	533-11		565		nm	Measurement @Peak (Fig.1)
Dominant Wavelength	λ <sub>d</sub>	533-11		569		nm	Note 3
Spectral Line Half-Width	Δλ	533-11		30		nm	
Forward Voltage	V <sub>F</sub>	533-11		2.1	2.6	V	I <sub>F</sub> = 20mA
Reverse Current	I <sub>R</sub>	533-11			100	μA	V <sub>R</sub> = 5V
Capacitance	C	533-11		35		pF	V <sub>F</sub> = 0, f = 1MHz

Note: 1. Luminous intensity is measured with a light sensor and filter combination that approximates the CIE eye-response curve.

2. θ<sub>1/2</sub> is the off-axis angle at which the luminous intensity is half the axial luminous intensity.

3. The dominant wavelength, λ<sub>d</sub> is derived from the CIE chromaticity diagram and represents the single wavelength which defines the color of the device.

4. I<sub>v</sub> needs ±15% additional for guaranteed limits.

### Typical Electrical / Optical Characteristics Curves

(25°C Ambient Temperature Unless Otherwise Noted)

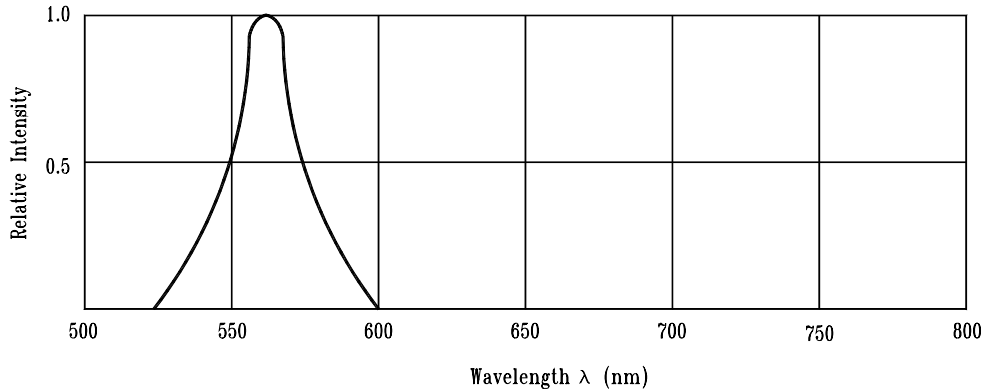

Fig.1 Relative Intensity vs. Wavelength

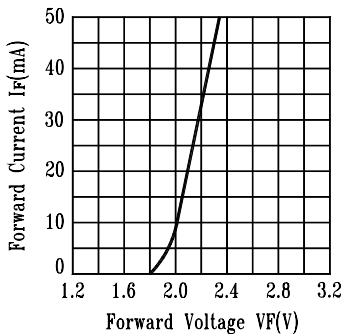

Fig.2 Forward Current vs. Forward Voltage

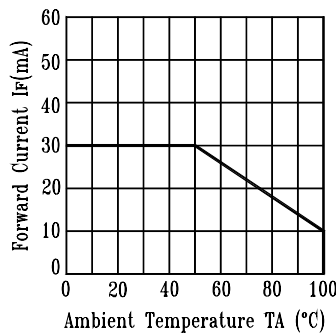

Fig.3 Forward Current Derating Curve

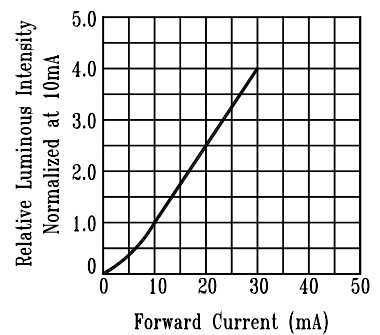

Fig.4 Relative Luminous Intensity vs. Forward Current

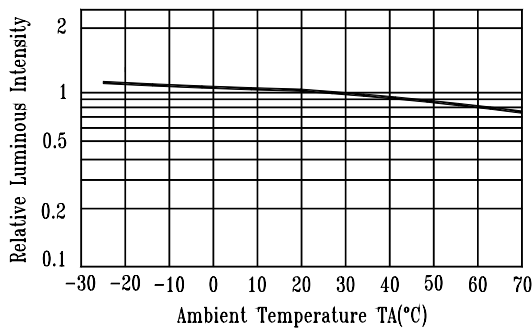

Fig.5 Luminous Intensity vs. Ambient Temperature

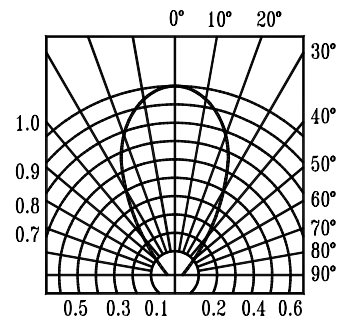

Fig.6 Spatial Distribution

## CAUTIONS

### 1. Application

The LEDs described here are intended to be used for ordinary electronic equipment (such as office equipment, communication equipment and household applications). Consult Liteon's Sales in advance for information on applications in which exceptional reliability is required, particularly when the failure or malfunction of the LEDs may directly jeopardize life or health (such as in aviation, transportation, traffic control equipment, medical and life support systems and safety devices).

### 2. Storage

The storage ambient for the LEDs should not exceed 30°C temperature or 70% relative humidity. It is recommended that LEDs out of their original packaging are used within three months.

For extended storage out of their original packaging, it is recommended that the LEDs be stored in a sealed container with appropriate desiccant or in a dessicator with nitrogen ambient.

### 3. Cleaning

Use alcohol-based cleaning solvents such as isopropyl alcohol to clean the LEDs if necessary.

### 4. Lead Forming & Assembly

During lead forming, the leads should be bent at a point at least 3mm from the base of LED lens. Do not use the base of the leadframe as a fulcrum during forming. Lead forming must be done before soldering at normal temperature. During assembly on PCB, use minimum clinch force possible to avoid excessive mechanical stress

### 5. Soldering

When soldering, leave a minimum of 2mm clearance from the base of the lens to the soldering point.

Dipping the lens into the solder must be avoided.

Do not apply any external stress to the lead frame during soldering while the LED is at high temperature.

Recommended soldering condition (for Lamp):

Soldering iron		Wave soldering	
Temperature	300°C Max.	Pre-heat	100°C Max.
Soldering time	3 sec. Max. (one time only)	Pre-heat time	60 sec. Max.
		Solder wave	260°C Max.
		Soldering time	10 sec. Max.

Note: Excessive soldering temperature and/or time might result in deformation of the LED lens or catastrophic failure of the LED. IR re-flow is not suitable process for through hole type LED lamp production.

### 6. Drive Method

An LED is a current operated device, In order to ensure intensity uniformity on multiple LEDs connected in parallel in an application; it is recommended that a current limiting resistor be incorporated in the drive circuit. In series with each LED as shown in Circuit A below.

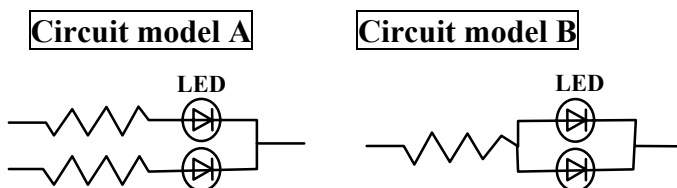

(A) Recommended circuit.  
 (B) The brightness of each LED might appear different due to the differences in the I-V characteristics of those LEDs



# LITE-ON TECHNOLOGY CORPORATION

Property of Lite-On Only

## 7. Others

The appearance and specifications of the product may be modified for improvement, without prior notice.

# Mouser Electronics

Authorized Distributor

Click to View Pricing, Inventory, Delivery & Lifecycle Information:

[Lite-On:](#)

[LTL-533-11](#)