

0.5mm Pitch  
SERIES

# 6298

0.5mmピッチ RA SMT 下接点 ワンタッチロック  
0.5mmPitch RA SMT Bottom contact One-touch lock

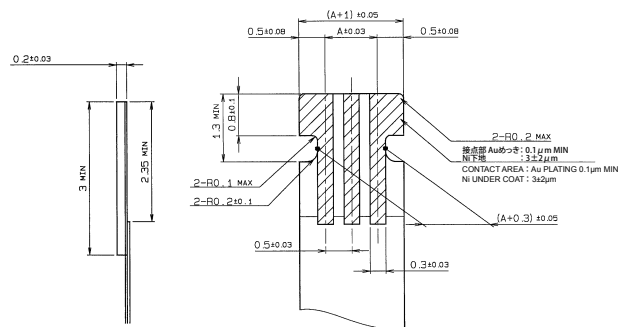
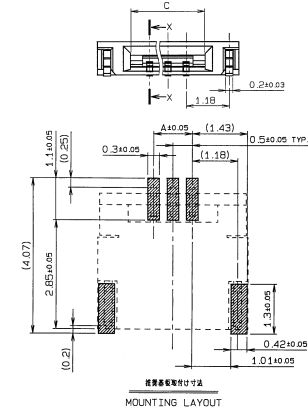
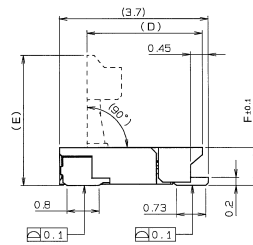
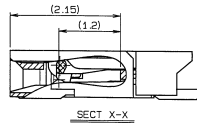
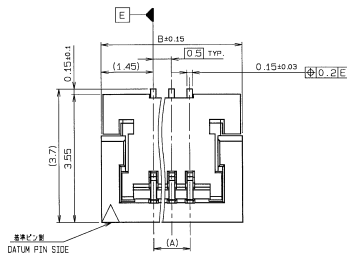

適用FPC  
APPLICABLE FPC

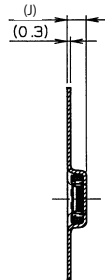
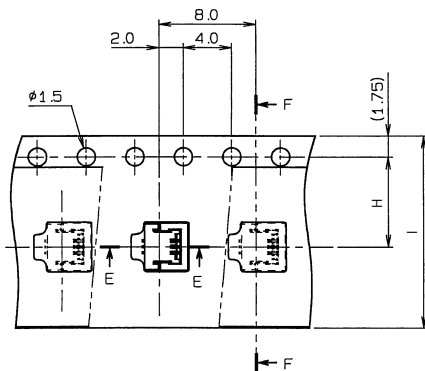

SECT F-F

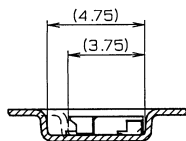

SECT E-E

極数 NO. OF POS.	A	B	C	D	E	F
3	1.0	3.9	2.1	2.87	3.2	0.9
4	1.5	4.4	2.6	2.87	3.2	0.9
5	2.0	4.9	3.1	2.87	3.2	0.9
6	2.5	5.4	3.6	2.87	3.2	0.9
8	3.5	6.4	4.6	2.87	3.2	0.9
9	4.0	6.9	5.1	2.87	3.2	0.9
11	5.0	7.9	6.1	3.12	3.3	1.1
13	6.0	8.9	7.1	3.12	3.3	1.1

極数 NO. OF POS.	H	I	J
3	7.5	16	1.6
4	7.5	16	1.6
5	7.5	16	1.6
6	7.5	16	1.6
8	7.5	16	1.6
9	7.5	16	1.6
11	11.5	24	1.8
13	11.5	24	1.8

注文コード ORDERING CODE

04 6298 0XX X00 883+

RoHS 対応品

RoHS Compliant Product

金めつき Au Plated

0 : 3-6 Positions  
1 : 8-13 Positions

極数 NUMBER OF POSITIONS

生産対応可能極数については、営業部に  
ご確認ください。

Feel free to contact our sales department  
for available numbers of positions.

梱包数量 3000個 /リール  
PACKING QUANTITY : 3000/Reel

# Mouser Electronics

Authorized Distributor

Click to View Pricing, Inventory, Delivery & Lifecycle Information:

[AVX:](#)

[046298008100883+](#) [046298009100883+](#) [046298003000883+](#) [046298005000883+](#) [046298011100883+](#)  
[046298013100883+](#) [046298004000883+](#) [046298006000883+](#)