

DATA SHEET

AV111-12, AV111-12LF: HIP3™ Variable Attenuator 0.80–1.00 GHz

Features

- 40 dBm IP3 typical
- Low loss 1 dB typical
- Attenuation 30 dB typical
- Good VSWR <1.5:1 typical
- Low phase shift
- Available lead (Pb)-free and RoHS-compliant MSL-1 @ 260 °C per JEDEC J-STD-020

Description

The AV111-12 is a current controlled, variable attenuator from Skyworks series of HIP3™ components. It is designed to meet the wide dynamic range required in spread spectrum, wireless base station applications. A monolithic quadrature hybrid is teamed with a silicon PIN diode pair in a plastic surface mount package reducing size and assuring consistency from part to part. AV111-12LF is packaged in a lead (Pb)-free, fully RoHS-compliant SOIC-8 package and is electrically identical to AV111-12.

NEW Skyworks offers lead (Pb)-free, RoHS (Restriction of Hazardous Substances)-compliant packaging.



Connection Diagram

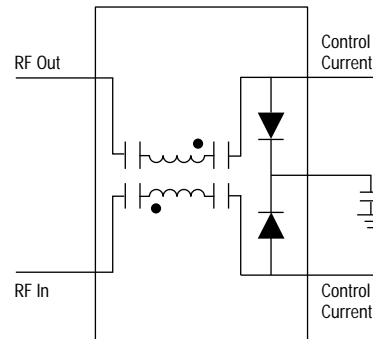

Electrical Specifications at 25 °C

Parameter	Min.	Typ.	Max.	Unit
Frequency	0.8		1	GHz
Insertion loss (0 mA control current)		1	1.5	dB
Attenuation @ 1.2 mA control current (900 MHz)	17.5		21.5	dB
VSWR all ports		1.5	1.8	
Input 3rd order intercept	37	40		dBm
Relative phase shift up to 20 dB attenuation ⁽¹⁾		7	10	Deg.
Group delay		0.4	0.9	ns

Operating Characteristics at 25 °C (0, 5 V)

Parameter ⁽²⁾	Condition	Frequency	Min.	Typ.	Max.	Unit
Switching characteristics ⁽³⁾						
Rise, fall	10/90% or 90/10% RF				5	µs
On, off	50% CTL to 90/10% RF				8	µs
Video feedthru (peak)					5	mV
Maximum input power for <1 dB attenuation variation					15	dBm

1. When built with external components as shown in the Pin Out diagram.

2. All measurements made in a 50 Ω system, unless otherwise specified.

3. 0–4 mA square wave total control current.

Typical Performance Data

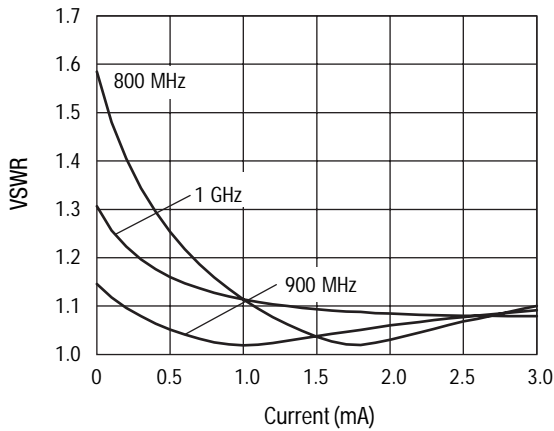

Input/Output VSWR vs. Current

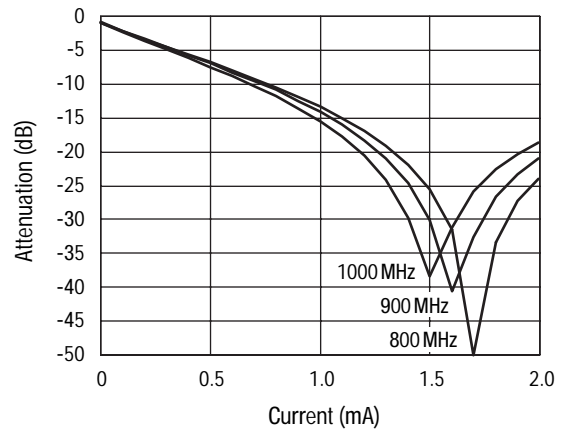

Attenuation vs. Current

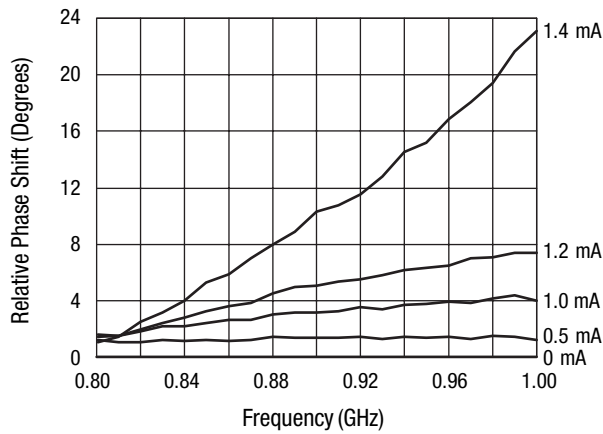

Relative Phase vs. Frequency

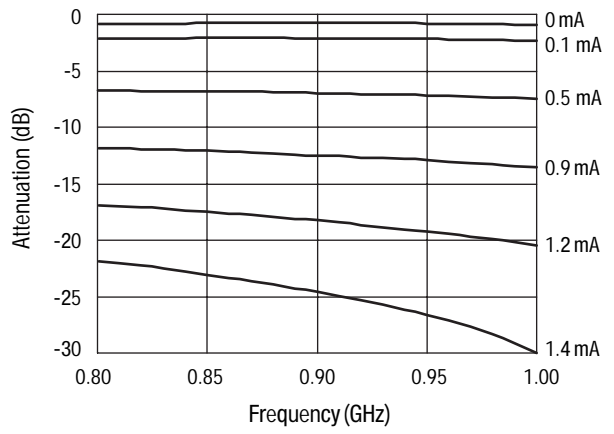

Attenuation vs. Frequency

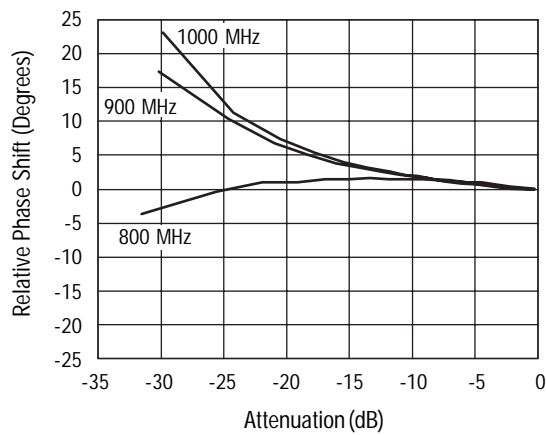

Relative Phase vs. Attenuation

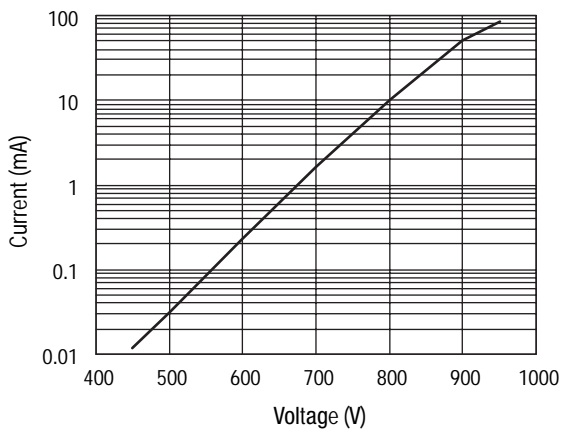

Typical PIN Diode Current vs. Voltage

Pin Out

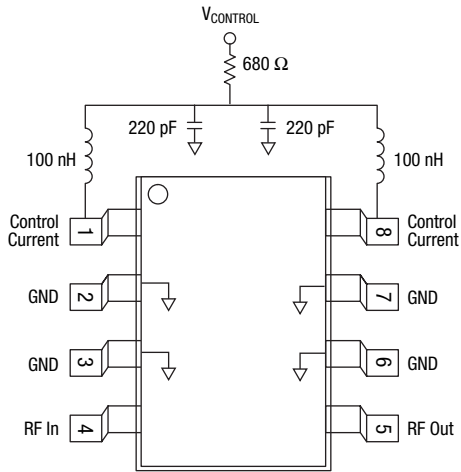

Recommended Board Layout

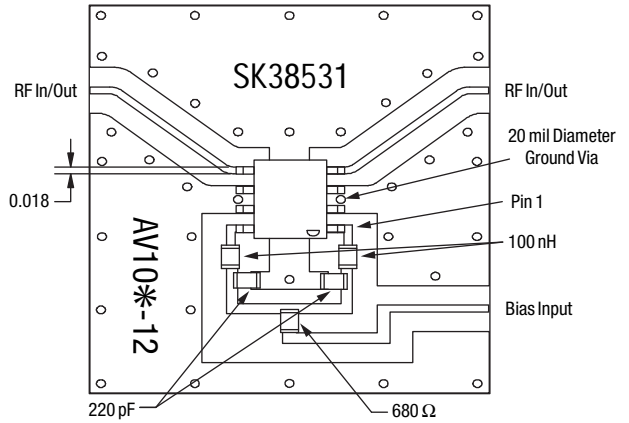

Material is 10 mil FR4.

Absolute Maximum Ratings

Characteristic	Value
RF input power	0.5 W CW, 4 W @ 12.5% duty cycle
Control current	50 mA per diode
Operating temperature	-40 °C to +85 °C
Storage temperature	-65 °C to +150 °C
Maximum reverse diode voltage	-100 V
Electrostatic discharge	125 V

Performance is guaranteed only under the conditions listed in the specifications table and is not guaranteed under the full range(s) described by the Absolute Maximum specifications. Exceeding any of the absolute maximum/minimum specifications may result in permanent damage to the device and will void the warranty.

CAUTION: Although this device is designed to be as robust as possible, ESD (Electrostatic Discharge) can damage this device. This device must be protected at all times from ESD. Static charges may easily produce potentials of several kilovolts on the human body or equipment, which can discharge without detection. Industry-standard ESD precautions must be employed at all times.

SOIC-8

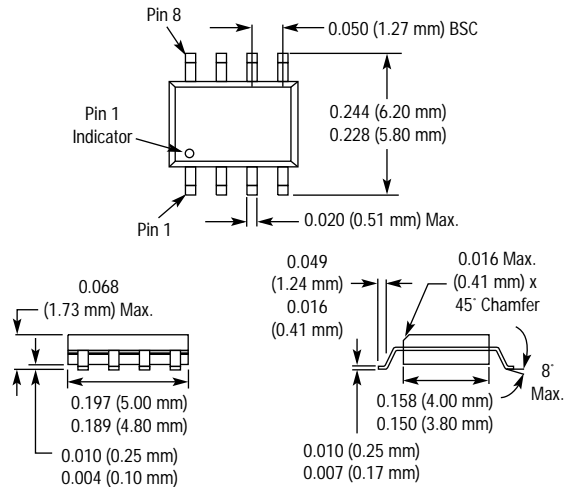

Recommended Solder Reflow Profiles

Refer to the [“Recommended Solder Reflow Profile”](#) Application Note.

Tape and Reel Information

Refer to the [“Discrete Devices and IC Switch/Attenuators Tape and Reel Package Orientation”](#) Application Note.

Copyright © 2002, 2003, 2004, 2005, 2006, 2007, Skyworks Solutions, Inc. All Rights Reserved.

Information in this document is provided in connection with Skyworks Solutions, Inc. ("Skyworks") products or services. These materials, including the information contained herein, are provided by Skyworks as a service to its customers and may be used for informational purposes only by the customer. Skyworks assumes no responsibility for errors or omissions in these materials or the information contained herein. Skyworks may change its documentation, products, services, specifications or product descriptions at any time, without notice. Skyworks makes no commitment to update the materials or information and shall have no responsibility whatsoever for conflicts, incompatibilities, or other difficulties arising from any future changes.

No license, whether express, implied, by estoppel or otherwise, is granted to any intellectual property rights by this document. Skyworks assumes no liability for any materials, products or information provided hereunder, including the sale, distribution, reproduction or use of Skyworks products, information or materials, except as may be provided in Skyworks Terms and Conditions of Sale.

THE MATERIALS, PRODUCTS AND INFORMATION ARE PROVIDED "AS IS" WITHOUT WARRANTY OF ANY KIND, WHETHER EXPRESS, IMPLIED, STATUTORY, OR OTHERWISE, INCLUDING FITNESS FOR A PARTICULAR PURPOSE OR USE, MERCHANTABILITY, PERFORMANCE, QUALITY OR NON-INFRINGEMENT OF ANY INTELLECTUAL PROPERTY RIGHT; ALL SUCH WARRANTIES ARE HEREBY EXPRESSLY DISCLAIMED. SKYWORKS DOES NOT WARRANT THE ACCURACY OR COMPLETENESS OF THE INFORMATION, TEXT, GRAPHICS OR OTHER ITEMS CONTAINED WITHIN THESE MATERIALS. SKYWORKS SHALL NOT BE LIABLE FOR ANY DAMAGES, INCLUDING BUT NOT LIMITED TO ANY SPECIAL, INDIRECT, INCIDENTAL, STATUTORY, OR CONSEQUENTIAL DAMAGES, INCLUDING WITHOUT LIMITATION, LOST REVENUES OR LOST PROFITS THAT MAY RESULT FROM THE USE OF THE MATERIALS OR INFORMATION, WHETHER OR NOT THE RECIPIENT OF MATERIALS HAS BEEN ADVISED OF THE POSSIBILITY OF SUCH DAMAGE.

Skyworks products are not intended for use in medical, lifesaving or life-sustaining applications, or other equipment in which the failure of the Skyworks products could lead to personal injury, death, physical or environmental damage. Skyworks customers using or selling Skyworks products for use in such applications do so at their own risk and agree to fully indemnify Skyworks for any damages resulting from such improper use or sale.

Customers are responsible for their products and applications using Skyworks products, which may deviate from published specifications as a result of design defects, errors, or operation of products outside of published parameters or design specifications. Customers should include design and operating safeguards to minimize these and other risks. Skyworks assumes no liability for applications assistance, customer product design, or damage to any equipment resulting from the use of Skyworks products outside of stated published specifications or parameters.

Skyworks, the Skyworks symbol, "Breakthrough Simplicity" and HIP3 are trademarks or registered trademarks of Skyworks Solutions, Inc., in the United States and other countries. Third-party brands and names are for identification purposes only, and are the property of their respective owners. Additional information, including relevant terms and conditions, posted at www.skyworksinc.com, are incorporated by reference.