

Analog Devices Welcomes Hittite Microwave Corporation

NO CONTENT ON THE ATTACHED DOCUMENT HAS CHANGED



THIS PAGE INTENTIONALLY LEFT BLANK

Typical Applications

The HMC467LP3 / HMC467LP3E is ideal for:

- Cellular; UMTS/3G Infrastructure
- Fixed Wireless & WLL
- Microwave Radio & VSAT
- Test Equipment

Functional Diagram

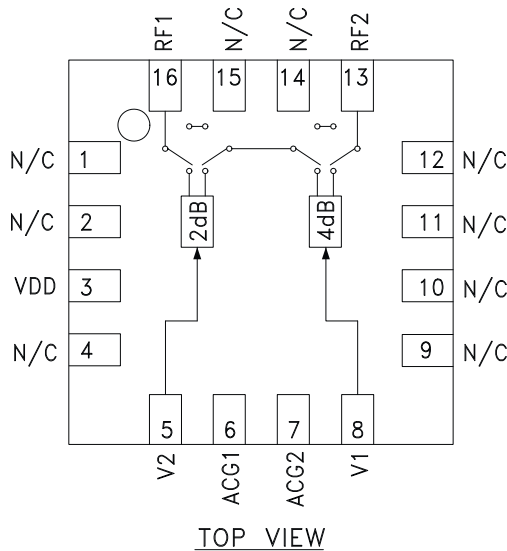

Features

- 2 dB LSB Steps to 6 dB
- High IP3: +50 dBm
- ± 0.2 dB Typical Bit Error
- Single Control Line Per Bit
- Single +5V Supply
- 3x3 mm SMT Package

General Description

The HMC467LP3 & HMC467LP3E are broadband 2-bit GaAs IC digital attenuators in low cost leadless surface mount packages. Covering DC to 6.0 GHz, the insertion loss is less than 0.7 dB typical. The attenuator bit values are 2 (LSB) and 4 dB for a total attenuation of 6 dB. Attenuation accuracy is excellent at ± 0.2 dB typical step error with an IIP3 of +50 dBm. Two control voltage inputs, toggled between 0 and +5V, are used to select each attenuation state. A single Vdd bias of +5V is required.

Electrical Specifications, $T_A = +25^\circ \text{C}$, With $V_{dd} = +5V$ & $V_{ctl} = 0/+5V^*$

Parameter	Frequency (GHz)	Min.	Typ.	Max.	Units
Insertion Loss	DC - 2.5 GHz 2.5 - 6.0 GHz		0.5 0.8	0.8 1.2	dB dB
Attenuation Range	DC - 6 GHz		6		dB
Return Loss (RF1 & RF2, All Atten. States)	DC - 2.5 GHz 2.5 - 6.0 GHz		20 15		dB dB
Attenuation Accuracy: (Referenced to Insertion Loss)	2 dB State 4, 6 dB States DC - 6 GHz	± 0.2 + 2% of Atten. Setting Max. ± 0.4 + 2% of Atten. Setting Max.			dB dB
Input Power for 0.1 dB Compression	0.25 - 6.0 GHz		22		dBm
Input Third Order Intercept Point (Two-Tone Input Power= 0 dBm Each Tone)	0.25 - 6.0 GHz		50		dBm
Switching Characteristics	DC - 6 GHz				
tRISE, tFALL (10/90% RF)			135		ns
tON, tOFF (50% CTL to 10/90% RF)			155		ns

* Bypass capacitor connecting ACG1 & ACG2 to RF ground required per pin description herein.

For price, delivery, and to place orders, please contact Hittite Microwave Corporation:
20 Alpha Road, Chelmsford, MA 01824 Phone: 978-250-3343 Fax: 978-250-3373
Order On-line at www.hittite.com

Insertion Loss

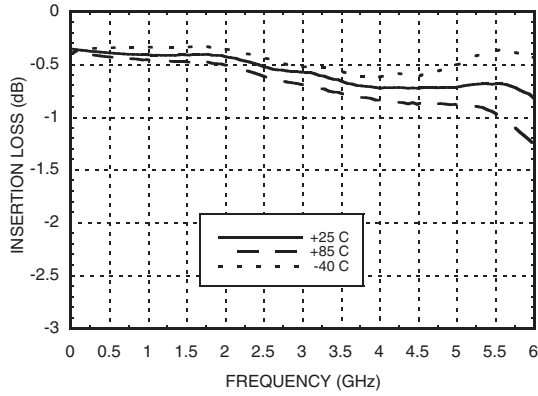

Return Loss RF1, RF2 (Only Major States are Shown)

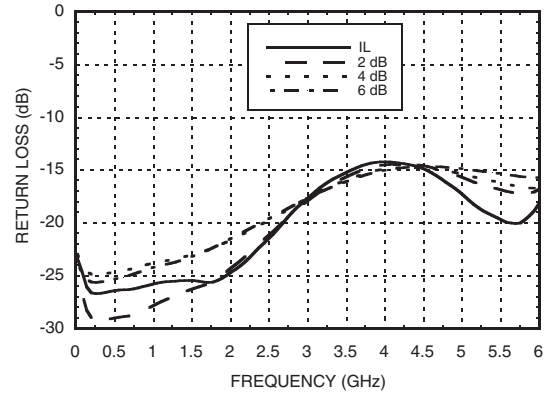

Normalized Attenuation (Only Major States are Shown)

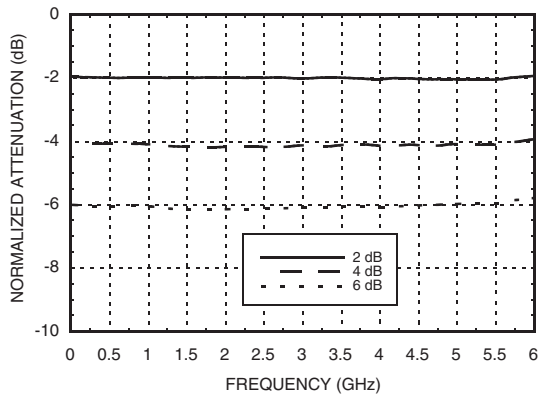

Bit Error vs. Attenuation State

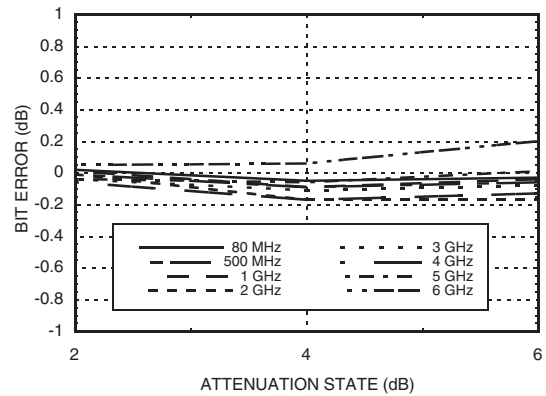

Bit Error vs. Frequency (Only Major States are Shown)

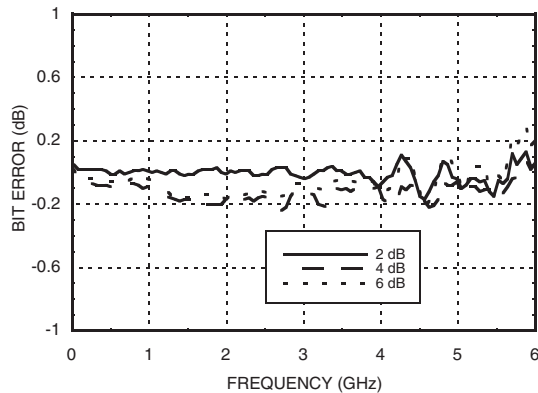

Relative Phase vs. Frequency (Only Major States are Shown)

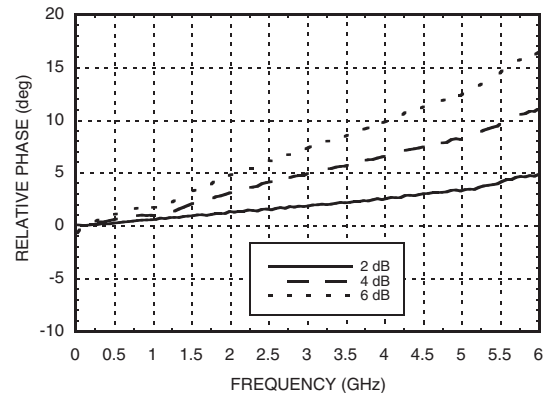



Worst Case Step Error Between Successive Attenuation States

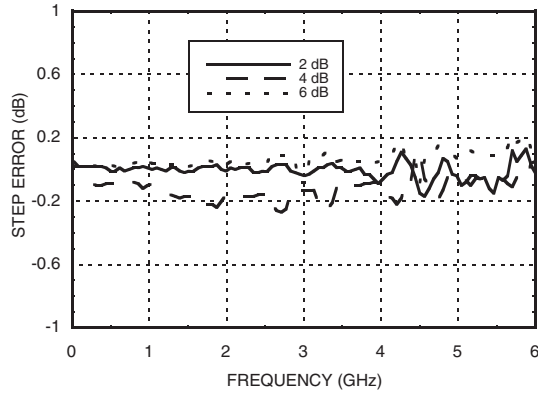

Truth Table

Control Voltage Input		Attenuation Setting RF1 - RF2
V1 4 dB	V2 2 dB	
High	High	Reference I.L.
High	Low	2 dB
Low	High	4 dB
Low	Low	6 dB Max. Atten.

Any combination of the above states will provide an attenuation approximately equal to the sum of the bits selected.

Bias Voltage & Current

Vdd Range= +5.0 Vdc ± 10%		
Vdd (Vdc)	Idd (Typ.) (mA)	Idd (Max.) (mA)
+5.0	0.7	1.2

TTL/CMOS Control Voltages

State	Bias Condition
Low	0 to 0.8 Vdc @ -5 uA Typ.
High	+2.0 to +5.0 Vdc @ 40 uA Typ.



Absolute Maximum Ratings

Control Voltage (V1, V2)	-0.5 Vdc to Vdd +1 Vdc
Bias Voltage (Vdd)	+7.0 Vdc
Storage Temperature	-65 to +150 °C
Operating Temperature	-40 to +85 °C
RF Input Power	+30 dBm
ESD Sensitivity (HBM)	Class 1A



ELECTROSTATIC SENSITIVE DEVICE
OBSERVE HANDLING PRECAUTIONS

Outline Drawing

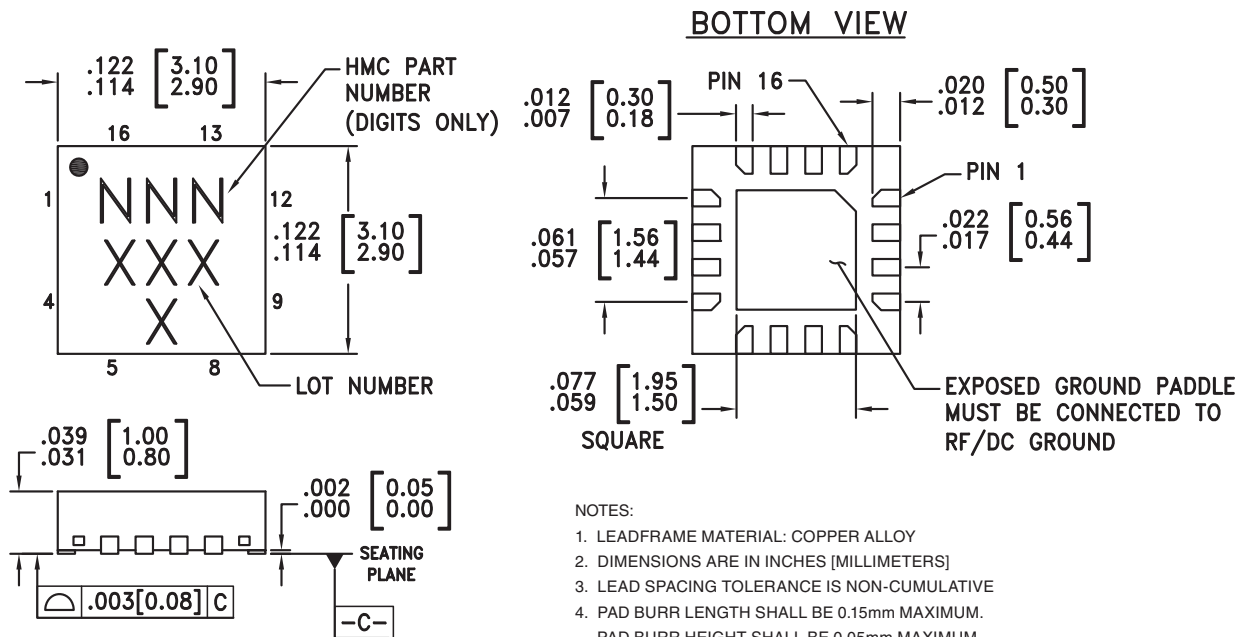

- NOTES:
1. LEADFRAME MATERIAL: COPPER ALLOY
 2. DIMENSIONS ARE IN INCHES [MILLIMETERS]
 3. LEAD SPACING TOLERANCE IS NON-CUMULATIVE
 4. PAD BURR LENGTH SHALL BE 0.15mm MAXIMUM. PAD BURR HEIGHT SHALL BE 0.05mm MAXIMUM.
 5. PACKAGE WARP SHALL NOT EXCEED 0.05mm.
 6. ALL GROUND LEADS AND GROUND PADDLE MUST BE SOLDERED TO PCB RF GROUND.
 7. REFER TO HITTITE APPLICATION NOTE FOR SUGGESTED LAND PATTERN.



Package Information

Part Number	Package Body Material	Lead Finish	MSL Rating	Package Marking ^[3]
HMC467LP3	Low Stress Injection Molded Plastic	Sn/Pb Solder	MSL1 ^[1]	467 XXXX
HMC467LP3E	RoHS-compliant Low Stress Injection Molded Plastic	100% matte Sn	MSL1 ^[2]	467 XXXX

[1] Max peak reflow temperature of 235 °C
 [2] Max peak reflow temperature of 260 °C
 [3] 4-Digit lot number XXXX

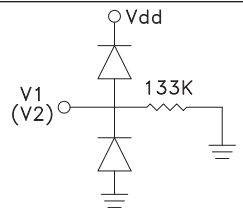
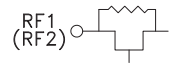

Pin Descriptions

Pin Number	Function	Description	Interface Schematic
1, 2, 4, 9 - 12, 14, 15	N/C	These pins should be connected to PCB RF ground to maximize performance.	
3	Vdd	Supply Voltage	
5, 8	V2, V1	See truth table and control voltage table.	
6, 7	ACG1, ACG2	External capacitor to ground is required. Select value for lowest frequency of operation. Place capacitor as close to pins as possible.	
13, 16	RF2, RF1	These pins are DC coupled and matched to 50 Ohm. Blocking capacitors are required.	
	GND	Package bottom has an exposed metal paddle that must be connected to RF/DC ground.	

Application Circuit

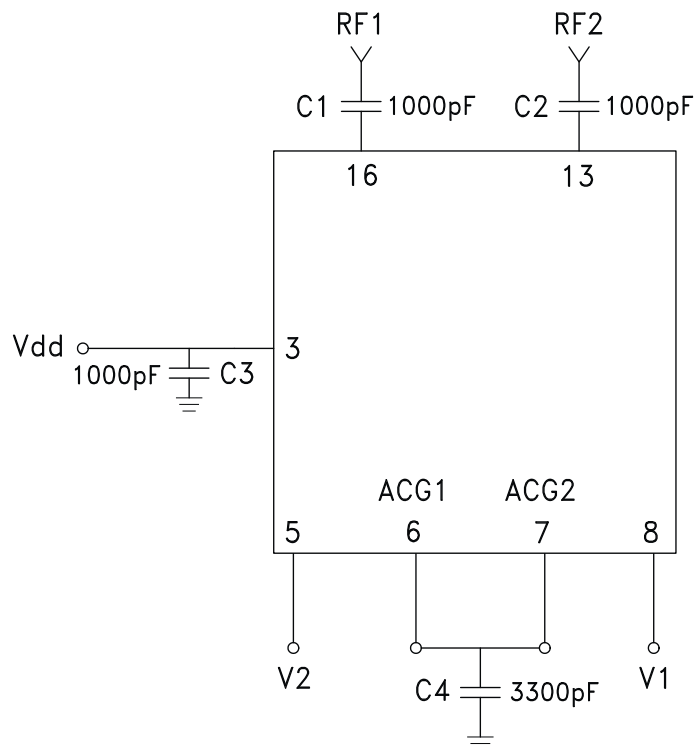

For price, delivery, and to place orders, please contact Hittite Microwave Corporation:
 20 Alpha Road, Chelmsford, MA 01824 Phone: 978-250-3343 Fax: 978-250-3373
 Order On-line at www.hittite.com



Evaluation PCB

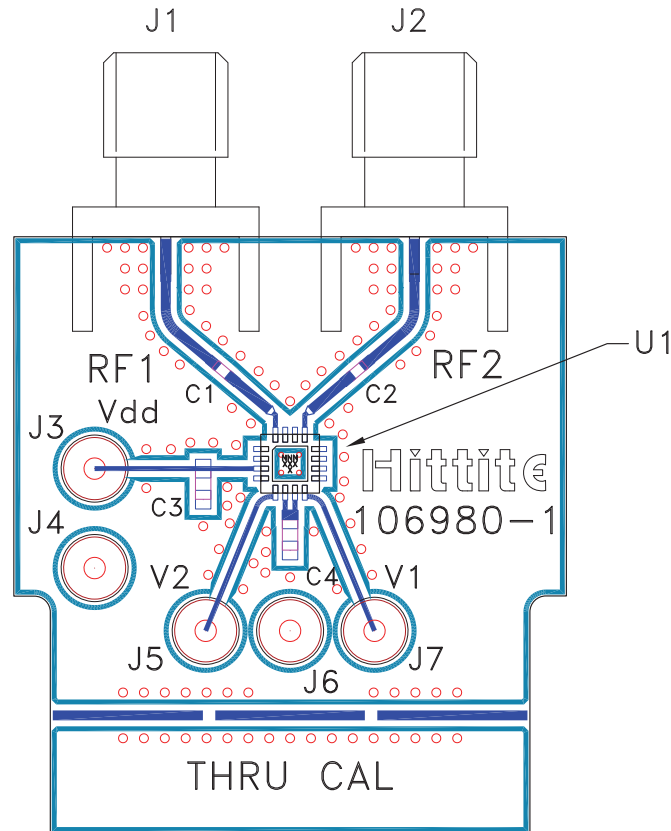

List of Materials for Evaluation PCB 107008 [1]

Item	Description
J1 - J2	PCB Mount SMA Connector
J3 - J7	DC Pin
C1, C2	1000 pF Capacitor, 0402 Pkg.
C3	1000 pF Capacitor, 0603 Pkg.
C4	3300 pF Capacitor, 0603 Pkg.
U1	HMC467LP3 / HMC467LP3E Digital Attenuator
PCB [2]	106980 Evaluation PCB

[1] Reference this number when ordering complete evaluation PCB

[2] Circuit Board Material: Rogers 4350

The circuit board used in the final application should use RF circuit design techniques. Signal lines should have 50 ohm impedance while the package ground leads and exposed paddle should be connected directly to the ground plane similar to that shown. A sufficient number of via holes should be used to connect the top and bottom ground planes. The evaluation circuit board shown is available from Hittite upon request.