

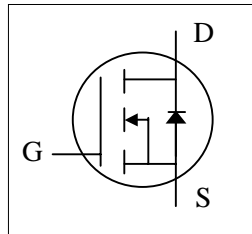

- ▼ Ease of Paralleling
- ▼ Fast Switching Characteristic
- ▼ Simple Drive Requirement



BV_{DSS}	500V
$R_{DS(ON)}$	0.85 Ω
I_D	8A

Description

APEC MOSFET provide the power designer with the best combination of fast switching , lower on-resistance and reasonable

The TO-220CFM isolation package is widely preferred for commercial-industrial through hole applications.

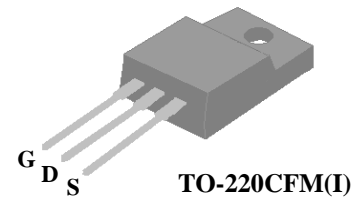

Absolute Maximum Ratings

Symbol	Parameter	Rating	Units
V_{DS}	Drain-Source Voltage	500	V
V_{GS}	Gate-Source Voltage	± 20	V
$I_D@T_C=25^\circ C$	Continuous Drain Current, V_{GS} @ 10V	8	A
$I_D@T_C=100^\circ C$	Continuous Drain Current, V_{GS} @ 10V	5.1	A
I_{DM}	Pulsed Drain Current ¹	32	A
$P_D@T_C=25^\circ C$	Total Power Dissipation	35	W
E_{AS}	Single Pulse Avalanche Energy ²	320	mJ
I_{AR}	Avalanche Current	8	A
T_{STG}	Storage Temperature Range	-55 to 150	$^\circ C$
T_J	Operating Junction Temperature Range	-55 to 150	$^\circ C$

Thermal Data

Symbol	Parameter	Value	Unit
Rthj-c	Maximum Thermal Resistance, Junction-case	3.6	$^\circ C/W$
Rthj-a	Maximum Thermal Resistance, Junction-ambient	65	$^\circ C/W$



Electrical Characteristics @ $T_j=25^{\circ}\text{C}$ (unless otherwise specified)

Symbol	Parameter	Test Conditions	Min.	Typ.	Max.	Units
BV_{DSS}	Drain-Source Breakdown Voltage	$V_{GS}=0V, I_D=1mA$	500	-	-	V
$R_{DS(ON)}$	Static Drain-Source On-Resistance ³	$V_{GS}=10V, I_D=4.8A$	-	-	0.85	Ω
$V_{GS(th)}$	Gate Threshold Voltage	$V_{DS}=V_{GS}, I_D=250\mu A$	2	-	4	V
g_{fs}	Forward Transconductance	$V_{DS}=10V, I_D=4.8A$	-	4.2	-	S
I_{DSS}	Drain-Source Leakage Current ($T_j=25^{\circ}\text{C}$)	$V_{DS}=500V, V_{GS}=0V$	-	-	25	μA
	Drain-Source Leakage Current ($T_j=125^{\circ}\text{C}$)	$V_{DS}=400V, V_{GS}=0V$	-	-	250	μA
I_{GSS}	Gate-Source Leakage	$V_{GS}=\pm 20V$	-	-	± 100	nA
Q_g	Total Gate Charge ³	$I_D=8A$	-	45	72	nC
Q_{gs}	Gate-Source Charge	$V_{DS}=400V$	-	7	-	nC
Q_{gd}	Gate-Drain ("Miller") Charge	$V_{GS}=10V$	-	25	-	nC
$t_{d(on)}$	Turn-on Delay Time ³	$V_{DD}=250V$	-	12	-	ns
t_r	Rise Time	$I_D=8A$	-	31	-	ns
$t_{d(off)}$	Turn-off Delay Time	$R_G=9.1\Omega, V_{GS}=10V$	-	48	-	ns
t_f	Fall Time	$R_D=31\Omega$	-	33	-	ns
C_{iss}	Input Capacitance	$V_{GS}=0V$	-	1250	2000	pF
C_{oss}	Output Capacitance	$V_{DS}=25V$	-	270	-	pF
C_{rss}	Reverse Transfer Capacitance	$f=1.0MHz$	-	85	-	pF
R_g	Gate Resistance	$f=1.0MHz$	-	1.6	2.4	Ω

Source-Drain Diode

Symbol	Parameter	Test Conditions	Min.	Typ.	Max.	Units
V_{SD}	Forward On Voltage ³	$T_j=25^{\circ}\text{C}, I_S=8A, V_{GS}=0V$	-	-	1.5	V
t_{rr}	Reverse Recovery Time ³	$I_S=8A, V_{GS}=0V,$	-	515	-	ns
Q_{rr}	Reverse Recovery Charge	$dI/dt=100A/\mu s$	-	8.6	-	μC

Notes:

- 1.Pulse width limited by Max. junction temperature.
- 2.Starting $T_j=25^{\circ}\text{C}$, $V_{DD}=50V$, $L=10mH$, $R_G=25\Omega$
- 3.Pulse test

THIS PRODUCT IS AN ELECTROSTATIC SENSITIVE, PLEASE HANDLE WITH CAUTION.

THIS PRODUCT HAS BEEN QUALIFIED FOR CONSUMER MARKET. APPLICATIONS OR USES AS CRITERIAL COMPONENT IN LIFE SUPPORT DEVICE OR SYSTEM ARE NOT AUTHORIZED.

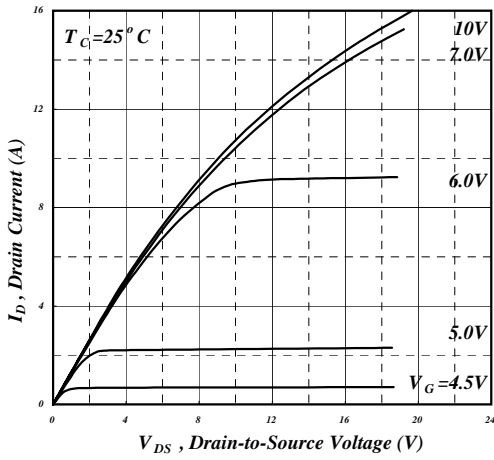

Fig 1. Typical Output Characteristics

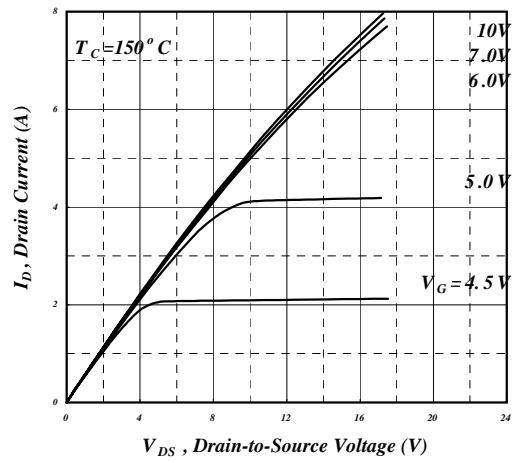

Fig 2. Typical Output Characteristics

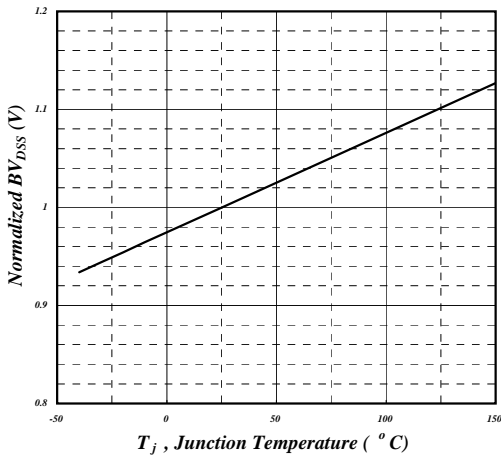

Fig 3. Normalized BV_{DSS} v.s. Junction Temperature

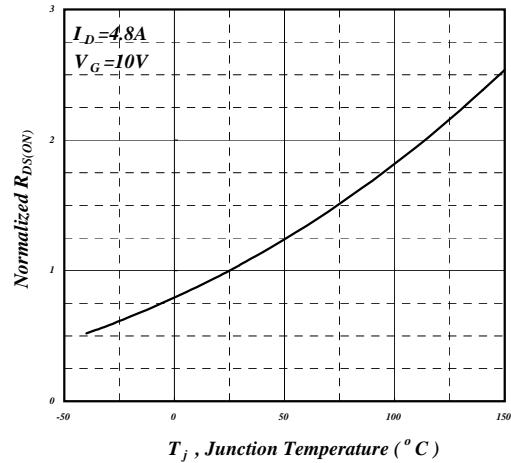

Fig 4. Normalized On-Resistance v.s. Junction Temperature

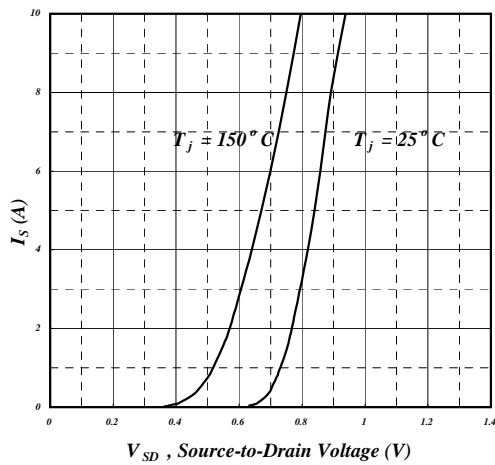

Fig 5. Forward Characteristic of Reverse Diode

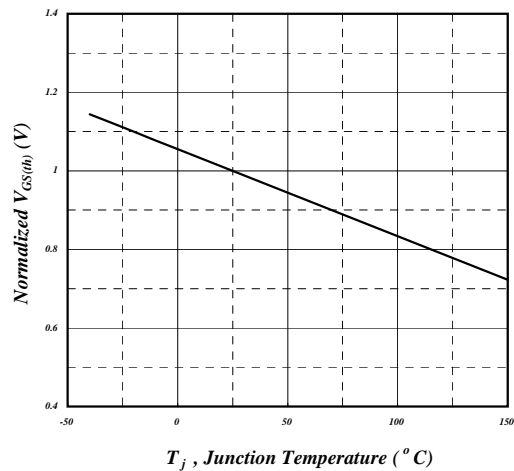

Fig 6. Gate Threshold Voltage v.s. Junction Temperature

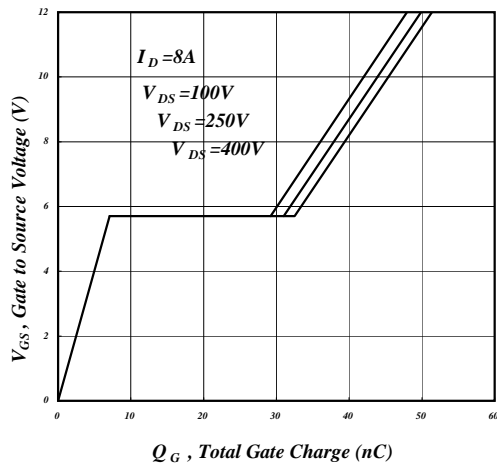

Fig 7. Gate Charge Characteristics

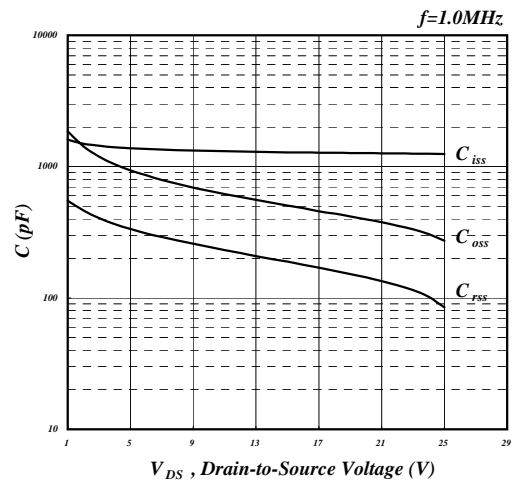

Fig 8. Typical Capacitance Characteristics

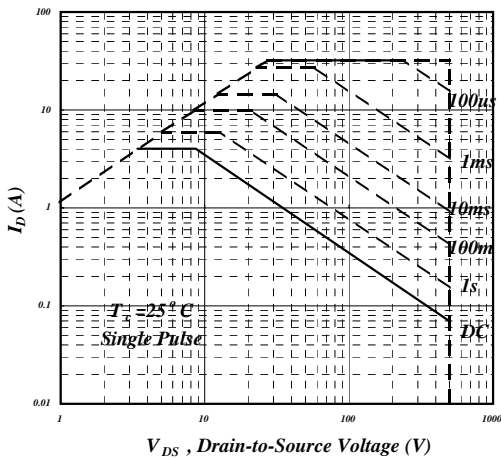

Fig 9. Maximum Safe Operating Area

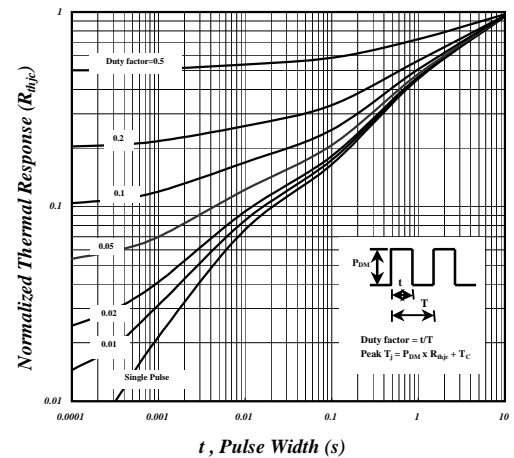

Fig 10. Effective Transient Thermal Impedance

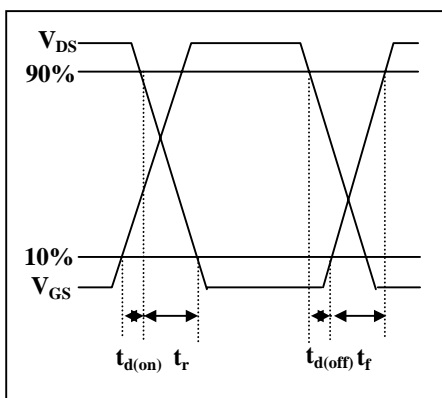

Fig 11. Switching Time Waveform

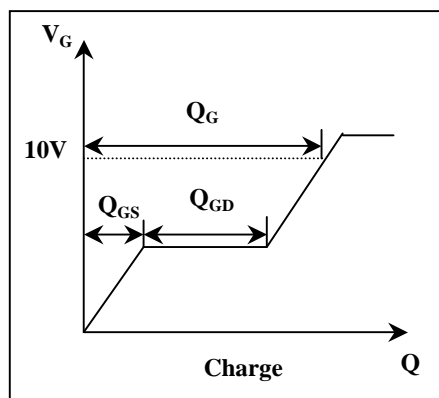
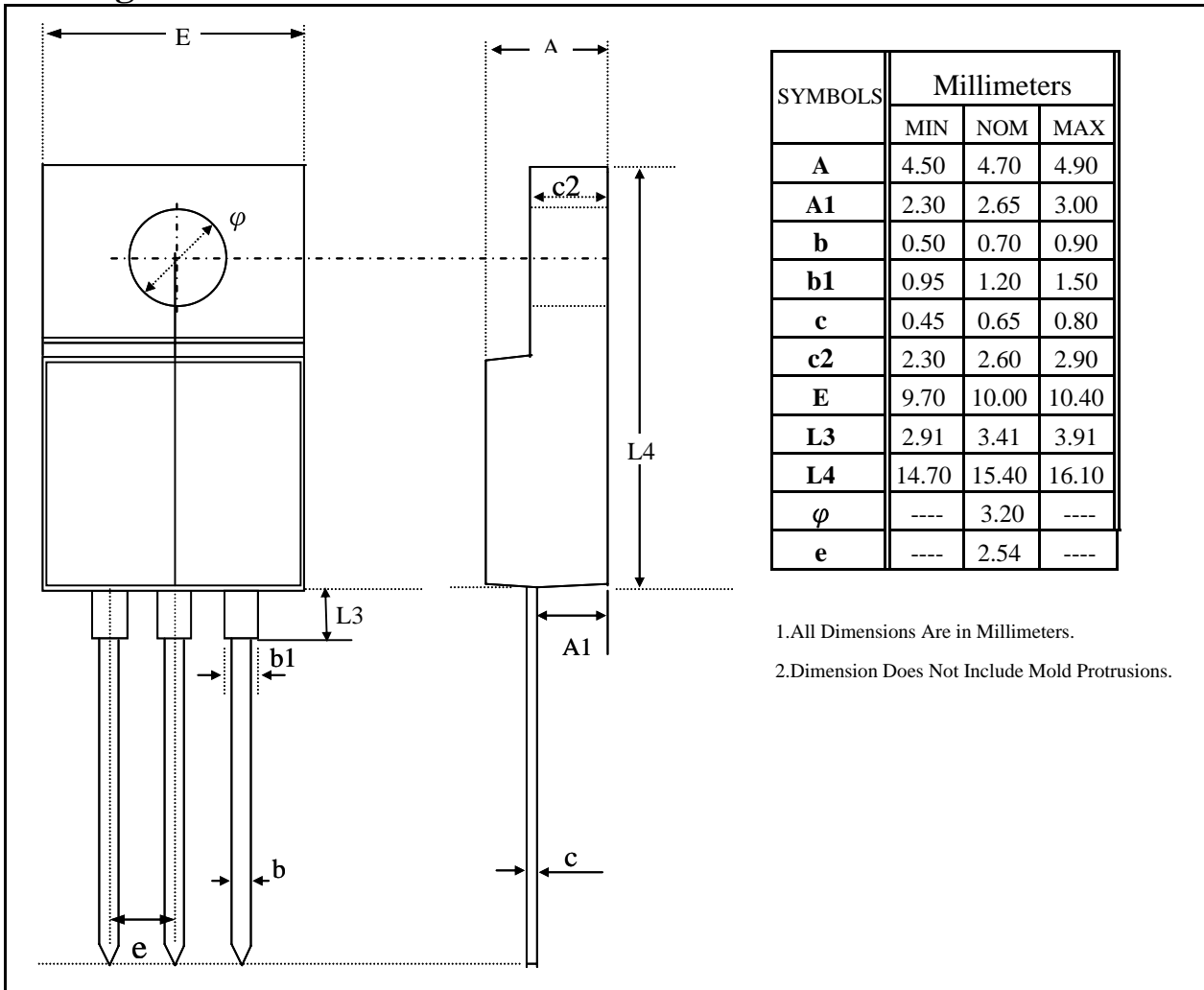

Fig 12. Gate Charge Waveform



Package Outline : TO-220CFM



Part Marking Information & Packing : TO-220CFM

