

BIPOLAR ANALOG INTEGRATED CIRCUIT
 μ PC79M00 Series

THREE TERMINAL NEGATIVE VOLTAGE REGULATOR

μ PC79M00 series are monolithic three terminal negative regulators which employ internally current limiting, thermal shut down, output transistor safe operating area protection make them essentially indestructible.

They are intended as fixed voltage regulators in a wide range of application including local on card regulation for elimination of distribution problems associated wide single point regulation.

FEATURES

- Output current out of 500 mA.
- On-chip some protection circuit (over current protection, SOA protection and thermal shut down).
- Low noise.

★ ORDERING INFORMATION

Part Number	Package	Output Voltage
μ PC79M05HF	3-pin plastic SIP (MP-45G) (isolated TO-220)	-5 V
μ PC79M08HF	3-pin plastic SIP (MP-45G) (isolated TO-220)	-8 V
μ PC79M12HF	3-pin plastic SIP (MP-45G) (isolated TO-220)	-12 V
μ PC79M15HF	3-pin plastic SIP (MP-45G) (isolated TO-220)	-15 V
μ PC79M18HF	3-pin plastic SIP (MP-45G) (isolated TO-220)	-18 V
μ PC79M24HF	3-pin plastic SIP (MP-45G) (isolated TO-220)	-24 V

EQUIVALENT CIRCUIT

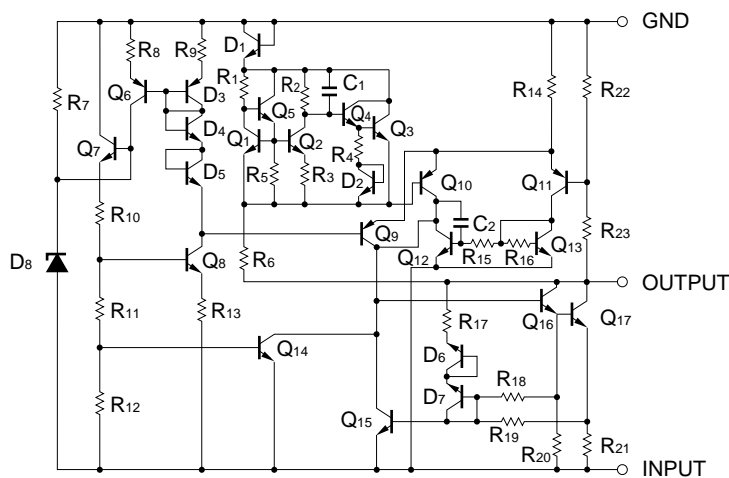

PIN CONFIGURATION (Marking Side)

3-pin plastic SIP (MP-45G)

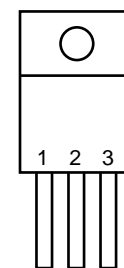

- 1: GND
- 2: INPUT
- 3: OUTPUT

The information in this document is subject to change without notice.

ABSOLUTE MAXIMUM RATINGS (T_A = 25 °C, unless otherwise specified)

Parameter	Symbol	Rating	Unit
Input Voltage	V _{IN}	-35/-40 ^{Note 1}	V
Internal Power Dissipation	P _T	15 ^{Note 2}	V
Operating Ambient Temperature	T _A	-20 to +85	°C
Operating Junction Temperature	T _J	-20 to +150	°C
Storage Temperature	T _{stg}	-55 to +150	°C
Thermal Resistance (junction to case)	R _{th(J-C)}	7	°C/W
Thermal Resistance (junction to ambient)	R _{th(J-A)}	65	°C/W

- Notes**
1. μPC79M05, 08, 12, 15, 18: -35 V, μPC79M24: -40 V
 2. Internally limited. When operating junction temperature rise up to 150 °C, the internal circuit shutdown output voltage.

Caution Exposure to Absolute Maximum Ratings for extended periods may affect device reliability; exceeding the ratings could cause permanent damage. The parameters apply independently. The device should be operated within the limits specified under DC and AC Characteristics.

TYPICAL CONNECTION

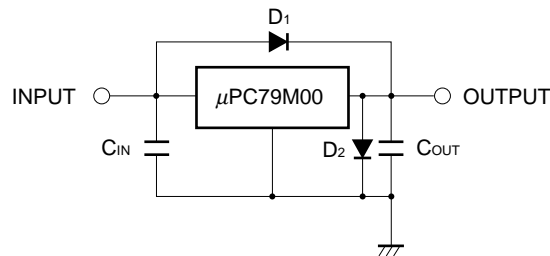

- C_{IN} : More than 2 μF.
- C_{OUT}: More than 1 μF.
- D₁ : Needed for V_{IN} > V_O.
- D₂ : Needed for V_O > GND.

RECOMMENDED OPERATING CONDITIONS

Parameter	Symbol	Part Number	MIN.	TYP.	MAX.	Unit
Input Voltage	V _{IN}	μPC79M05	-7	-10	-25	V
		μPC79M08	-10.5	-14	-25	
		μPC79M12	-14.5	-19	-30	
		μPC79M15	-17.5	-23	-30	
		μPC79M18	-21	-27	-33	
		μPC79M24	-27	-33	-38	
Output Current	I _O	All	5		350	mA
Operating Junction Temperature	T _J	All	-20		+125	°C

ELECTRICAL CHARACTERISTICS

μPC79M05

($V_{IN} = -10\text{ V}$, $I_o = 350\text{ mA}$, $0\text{ }^{\circ}\text{C} \leq T_J \leq +125\text{ }^{\circ}\text{C}$, $C_{IN} = 2.2\text{ }\mu\text{F}$, $C_{OUT} = 1\text{ }\mu\text{F}$, unless otherwise specified)

Parameter	Symbol	Test Conditions	MIN.	TYP.	MAX.	Unit
Output Voltage	V_o	$T_J = 25\text{ }^{\circ}\text{C}$	-4.8	-5.0	-5.2	V
		$-7\text{ V} \leq V_{IN} \leq -25\text{ V}$, $5\text{ mA} \leq I_o \leq 350\text{ mA}$	-4.75		-5.25	
Line Regulation	REG _{IN}	$T_J = 25\text{ }^{\circ}\text{C}$, $-7\text{ V} \leq V_{IN} \leq -25\text{ V}$		18	50	mV
		$T_J = 25\text{ }^{\circ}\text{C}$, $-8\text{ V} \leq V_{IN} \leq -18\text{ V}$		10	30	
Load Regulation	REG _L	$T_J = 25\text{ }^{\circ}\text{C}$, $5\text{ mA} \leq I_o \leq 500\text{ mA}$		15	100	mV
		$T_J = 25\text{ }^{\circ}\text{C}$, $5\text{ mA} \leq I_o \leq 350\text{ mA}$		10		
Quiescent Current	I_{BIAS}	$T_J = 25\text{ }^{\circ}\text{C}$		4.3	6.0	mA
Quiescent Current Change	ΔI_{BIAS}	$-8\text{ V} \leq V_{IN} \leq -25\text{ V}$			0.5	mA
		$5\text{ mA} \leq I_o \leq 350\text{ mA}$			0.4	
Output Noise Voltage	V_n	$T_J = 25\text{ }^{\circ}\text{C}$, $10\text{ Hz} \leq f \leq 100\text{ kHz}$		45	200	$\mu\text{V}_{r.m.s.}$
Ripple Rejection	$R \cdot R$	$T_J = 25\text{ }^{\circ}\text{C}$, $f = 120\text{ Hz}$, $-8\text{ V} \leq V_{IN} \leq -18\text{ V}$, $I_o = 100\text{ mA}$	50	72		dB
Dropout Voltage	V_{DIF}	$T_J = 25\text{ }^{\circ}\text{C}$		1.1		V
Short Circuit Current	I_{Oshort}	$T_J = 25\text{ }^{\circ}\text{C}$, $V_{IN} = -25\text{ V}$		500		mA
Peak Output Current	I_{Opeak}	$T_J = 25\text{ }^{\circ}\text{C}$	620	880	1 020	mA
Temperature Coefficient of Output Voltage	$\Delta V_o/\Delta T$	$I_o = 5\text{ mA}$		0.2		$\text{mV}/^{\circ}\text{C}$

μPC79M08

($V_{IN} = -14\text{ V}$, $I_o = 350\text{ mA}$, $0\text{ }^{\circ}\text{C} \leq T_J \leq +125\text{ }^{\circ}\text{C}$, $C_{IN} = 2.2\text{ }\mu\text{F}$, $C_{OUT} = 1\text{ }\mu\text{F}$, unless otherwise specified)

Parameter	Symbol	Test Conditions	MIN.	TYP.	MAX.	Unit
Output Voltage	V_o	$T_J = 25\text{ }^{\circ}\text{C}$	-7.7	-8.0	-8.3	V
		$-10.5\text{ V} \leq V_{IN} \leq -25\text{ V}$, $5\text{ mA} \leq I_o \leq 350\text{ mA}$	-7.6		-8.4	
Line Regulation	REG _{IN}	$T_J = 25\text{ }^{\circ}\text{C}$, $-10.5\text{ V} \leq V_{IN} \leq -25\text{ V}$		20	80	mV
		$T_J = 25\text{ }^{\circ}\text{C}$, $-11\text{ V} \leq V_{IN} \leq -21\text{ V}$		15	50	
Load Regulation	REG _L	$T_J = 25\text{ }^{\circ}\text{C}$, $5\text{ mA} \leq I_o \leq 500\text{ mA}$		20	160	mV
		$T_J = 25\text{ }^{\circ}\text{C}$, $5\text{ mA} \leq I_o \leq 350\text{ mA}$		15		
Quiescent Current	I_{BIAS}	$T_J = 25\text{ }^{\circ}\text{C}$		4.3	6.0	mA
Quiescent Current Change	ΔI_{BIAS}	$-10.5\text{ V} \leq V_{IN} \leq -25\text{ V}$			0.5	mA
		$5\text{ mA} \leq I_o \leq 350\text{ mA}$			0.4	
Output Noise Voltage	V_n	$T_J = 25\text{ }^{\circ}\text{C}$, $10\text{ Hz} \leq f \leq 100\text{ kHz}$		65	220	$\mu\text{V}_{r.m.s.}$
Ripple Rejection	$R \cdot R$	$T_J = 25\text{ }^{\circ}\text{C}$, $f = 120\text{ Hz}$, $-11.5\text{ V} \leq V_{IN} \leq -21.5\text{ V}$, $I_o = 100\text{ mA}$	50	66		dB
Dropout Voltage	V_{DIF}	$T_J = 25\text{ }^{\circ}\text{C}$		1.1		V
Short Circuit Current	I_{Oshort}	$T_J = 25\text{ }^{\circ}\text{C}$, $V_{IN} = -25\text{ V}$		500		mA
Peak Output Current	I_{Opeak}	$T_J = 25\text{ }^{\circ}\text{C}$	620	880	1 020	mA
Temperature Coefficient of Output Voltage	$\Delta V_o/\Delta T$	$I_o = 5\text{ mA}$		0.3		$\text{mV}/^{\circ}\text{C}$

μPC79M12

($V_{IN} = -19\text{ V}$, $I_o = 350\text{ mA}$, $0\text{ }^{\circ}\text{C} \leq T_J \leq +125\text{ }^{\circ}\text{C}$, $C_{IN} = 2.2\text{ }\mu\text{F}$, $C_{OUT} = 1\text{ }\mu\text{F}$, unless otherwise specified)

Parameter	Symbol	Test Conditions	MIN.	TYP.	MAX.	Unit
Output Voltage	V_o	$T_J = 25\text{ }^{\circ}\text{C}$	-11.5	-12	-12.5	V
		$-14.5\text{ V} \leq V_{IN} \leq -30\text{ V}$, $5\text{ mA} \leq I_o \leq 350\text{ mA}$	-11.4		-12.6	
Line Regulation	REG _{IN}	$T_J = 25\text{ }^{\circ}\text{C}$, $-14.5\text{ V} \leq V_{IN} \leq -30\text{ V}$		25	80	mV
		$T_J = 25\text{ }^{\circ}\text{C}$, $-15\text{ V} \leq V_{IN} \leq -25\text{ V}$		20	50	
Load Regulation	REG _L	$T_J = 25\text{ }^{\circ}\text{C}$, $5\text{ mA} \leq I_o \leq 500\text{ mA}$		35	240	mV
		$T_J = 25\text{ }^{\circ}\text{C}$, $5\text{ mA} \leq I_o \leq 350\text{ mA}$		25		
Quiescent Current	I_{BIAS}	$T_J = 25\text{ }^{\circ}\text{C}$		4.4	6.0	mA
Quiescent Current Change	ΔI_{BIAS}	$-14.5\text{ V} \leq V_{IN} \leq -30\text{ V}$			0.5	mA
		$5\text{ mA} \leq I_o \leq 350\text{ mA}$			0.4	
Output Noise Voltage	V_n	$T_J = 25\text{ }^{\circ}\text{C}$, $10\text{ Hz} \leq f \leq 100\text{ kHz}$		125	280	$\mu\text{V}_{r.m.s.}$
Ripple Rejection	$R \cdot R$	$T_J = 25\text{ }^{\circ}\text{C}$, $f = 120\text{ Hz}$, $-15\text{ V} \leq V_{IN} \leq -25\text{ V}$, $I_o = 100\text{ mA}$	50	64		dB
Dropout Voltage	V_{DIF}	$T_J = 25\text{ }^{\circ}\text{C}$		1.1		V
Short Circuit Current	I_{Oshort}	$T_J = 25\text{ }^{\circ}\text{C}$, $V_{IN} = -30\text{ V}$		400		mA
Peak Output Current	I_{Opeak}	$T_J = 25\text{ }^{\circ}\text{C}$	620	880	1 020	mA
Temperature Coefficient of Output Voltage	$\Delta V_o/\Delta T$	$I_o = 5\text{ mA}$		0.4		$\text{mV}/^{\circ}\text{C}$

μPC79M15

($V_{IN} = -23\text{ V}$, $I_o = 350\text{ mA}$, $0\text{ }^{\circ}\text{C} \leq T_J \leq +125\text{ }^{\circ}\text{C}$, $C_{IN} = 2.2\text{ }\mu\text{F}$, $C_{OUT} = 1\text{ }\mu\text{F}$, unless otherwise specified)

Parameter	Symbol	Test Conditions	MIN.	TYP.	MAX.	Unit
Output Voltage	V_o	$T_J = 25\text{ }^{\circ}\text{C}$	-14.4	-15	-15.6	V
		$-17.5\text{ V} \leq V_{IN} \leq -30\text{ V}$, $5\text{ mA} \leq I_o \leq 350\text{ mA}$	-14.25		-15.75	
Line Regulation	REG _{IN}	$T_J = 25\text{ }^{\circ}\text{C}$, $-17.5\text{ V} \leq V_{IN} \leq -30\text{ V}$		30	80	mV
		$T_J = 25\text{ }^{\circ}\text{C}$, $-18\text{ V} \leq V_{IN} \leq -28\text{ V}$		25	50	
Load Regulation	REG _L	$T_J = 25\text{ }^{\circ}\text{C}$, $5\text{ mA} \leq I_o \leq 500\text{ mA}$		50	240	mV
		$T_J = 25\text{ }^{\circ}\text{C}$, $5\text{ mA} \leq I_o \leq 350\text{ mA}$		35		
Quiescent Current	I_{BIAS}	$T_J = 25\text{ }^{\circ}\text{C}$		4.4	6.0	mA
Quiescent Current Change	ΔI_{BIAS}	$-17.5\text{ V} \leq V_{IN} \leq -30\text{ V}$			0.5	mA
		$5\text{ mA} \leq I_o \leq 350\text{ mA}$			0.4	
Output Noise Voltage	V_n	$T_J = 25\text{ }^{\circ}\text{C}$, $10\text{ Hz} \leq f \leq 100\text{ kHz}$		150	360	$\mu\text{V}_{r.m.s.}$
Ripple Rejection	$R \cdot R$	$T_J = 25\text{ }^{\circ}\text{C}$, $f = 120\text{ Hz}$, $-18.5\text{ V} \leq V_{IN} \leq -28.5\text{ V}$, $I_o = 100\text{ mA}$	50	62		dB
Dropout Voltage	V_{DIF}	$T_J = 25\text{ }^{\circ}\text{C}$		1.1		V
Short Circuit Current	I_{Oshort}	$T_J = 25\text{ }^{\circ}\text{C}$, $V_{IN} = -30\text{ V}$		400		mA
Peak Output Current	I_{Opeak}	$T_J = 25\text{ }^{\circ}\text{C}$	620	880	1 020	mA
Temperature Coefficient of Output Voltage	$\Delta V_o/\Delta T$	$I_o = 5\text{ mA}$		0.6		$\text{mV}/^{\circ}\text{C}$

μPC79M18

($V_{IN} = -27\text{ V}$, $I_o = 350\text{ mA}$, $0\text{ }^\circ\text{C} \leq T_J \leq +125\text{ }^\circ\text{C}$, $C_{IN} = 2.2\text{ }\mu\text{F}$, $C_{OUT} = 1\text{ }\mu\text{F}$, unless otherwise specified)

Parameter	Symbol	Test Conditions	MIN.	TYP.	MAX.	Unit
Output Voltage	V_o	$T_J = 25\text{ }^\circ\text{C}$	-17.3	-18	-18.7	V
		$-21\text{ V} \leq V_{IN} \leq -33\text{ V}$, $5\text{ mA} \leq I_o \leq 350\text{ mA}$	-17.1		-18.9	
Line Regulation	REG _{IN}	$T_J = 25\text{ }^\circ\text{C}$, $-21\text{ V} \leq V_{IN} \leq -33\text{ V}$		30	80	mV
		$T_J = 25\text{ }^\circ\text{C}$, $-24\text{ V} \leq V_{IN} \leq -30\text{ V}$		25	50	
Load Regulation	REG _L	$T_J = 25\text{ }^\circ\text{C}$, $5\text{ mA} \leq I_o \leq 500\text{ mA}$		60	300	mV
		$T_J = 25\text{ }^\circ\text{C}$, $5\text{ mA} \leq I_o \leq 350\text{ mA}$		45		
Quiescent Current	I_{BIAS}	$T_J = 25\text{ }^\circ\text{C}$		4.4	6.0	mA
Quiescent Current Change	ΔI_{BIAS}	$-21\text{ V} \leq V_{IN} \leq -33\text{ V}$			0.5	mA
		$5\text{ mA} \leq I_o \leq 350\text{ mA}$			0.4	
Output Noise Voltage	V_n	$T_J = 25\text{ }^\circ\text{C}$, $10\text{ Hz} \leq f \leq 100\text{ kHz}$		200	440	$\mu\text{V}_{r.m.s.}$
Ripple Rejection	$R \cdot R$	$T_J = 25\text{ }^\circ\text{C}$, $f = 120\text{ Hz}$, $-22\text{ V} \leq V_{IN} \leq -32\text{ V}$, $I_o = 100\text{ mA}$	50	60		dB
Dropout Voltage	V_{DIF}	$T_J = 25\text{ }^\circ\text{C}$		1.1		V
Short Circuit Current	I_{short}	$T_J = 25\text{ }^\circ\text{C}$, $V_{IN} = -33\text{ V}$		350		mA
Peak Output Current	I_{peak}	$T_J = 25\text{ }^\circ\text{C}$	620	880	1 020	mA
Temperature Coefficient of Output Voltage	$\Delta V_o/\Delta T$	$I_o = 5\text{ mA}$		0.8		$\text{mV}/^\circ\text{C}$

μPC79M24

($V_{IN} = -33\text{ V}$, $I_o = 350\text{ mA}$, $0\text{ }^\circ\text{C} \leq T_J \leq +125\text{ }^\circ\text{C}$, $C_{IN} = 2.2\text{ }\mu\text{F}$, $C_{OUT} = 1\text{ }\mu\text{F}$, unless otherwise specified)

Parameter	Symbol	Test Conditions	MIN.	TYP.	MAX.	Unit
Output Voltage	V_o	$T_J = 25\text{ }^\circ\text{C}$	-23.0	-24	-25.0	V
		$-27\text{ V} \leq V_{IN} \leq -38\text{ V}$, $5\text{ mA} \leq I_o \leq 350\text{ mA}$	-22.8		-25.2	
Line Regulation	REG _{IN}	$T_J = 25\text{ }^\circ\text{C}$, $-27\text{ V} \leq V_{IN} \leq -38\text{ V}$		30	80	mV
		$T_J = 25\text{ }^\circ\text{C}$, $-30\text{ V} \leq V_{IN} \leq -36\text{ V}$		25	50	
Load Regulation	REG _L	$T_J = 25\text{ }^\circ\text{C}$, $5\text{ mA} \leq I_o \leq 500\text{ mA}$		80	360	mV
		$T_J = 25\text{ }^\circ\text{C}$, $5\text{ mA} \leq I_o \leq 350\text{ mA}$		50		
Quiescent Current	I_{BIAS}	$T_J = 25\text{ }^\circ\text{C}$		4.5	6.0	mA
Quiescent Current Change	ΔI_{BIAS}	$-27\text{ V} \leq V_{IN} \leq -38\text{ V}$			0.5	mA
		$5\text{ mA} \leq I_o \leq 350\text{ mA}$			0.4	
Output Noise Voltage	V_n	$T_J = 25\text{ }^\circ\text{C}$, $10\text{ Hz} \leq f \leq 100\text{ kHz}$		250	600	$\mu\text{V}_{r.m.s.}$
Ripple Rejection	$R \cdot R$	$T_J = 25\text{ }^\circ\text{C}$, $f = 120\text{ Hz}$, $-28\text{ V} \leq V_{IN} \leq -38\text{ V}$, $I_o = 100\text{ mA}$	50	57		dB
Dropout Voltage	V_{DIF}	$T_J = 25\text{ }^\circ\text{C}$		1.1		V
Short Circuit Current	I_{short}	$T_J = 25\text{ }^\circ\text{C}$, $V_{IN} = -38\text{ V}$		200		mA
Peak Output Current	I_{peak}	$T_J = 25\text{ }^\circ\text{C}$	620	880	1 020	mA
Temperature Coefficient of Output Voltage	$\Delta V_o/\Delta T$	$I_o = 5\text{ mA}$		1.0		$\text{mV}/^\circ\text{C}$

TYPICAL CHARACTERISTICS ($T_A = 25\text{ }^\circ\text{C}$, unless otherwise specified)

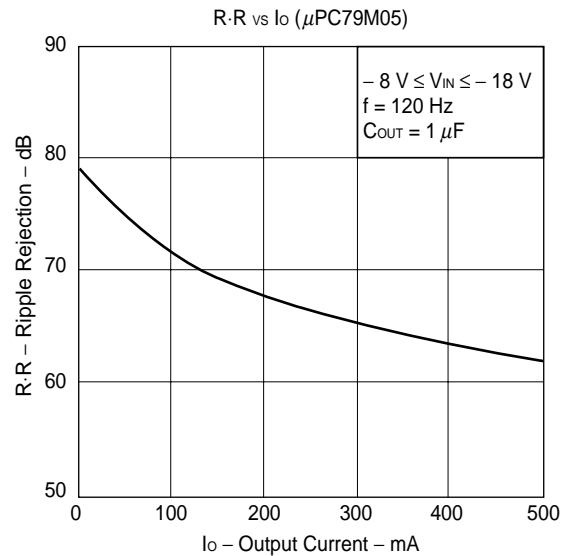
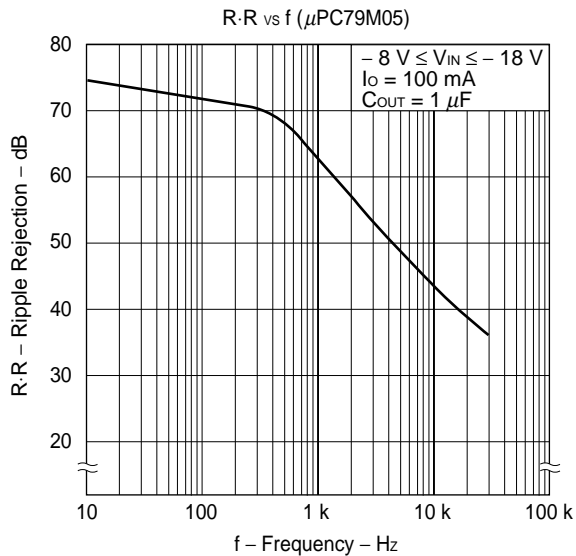
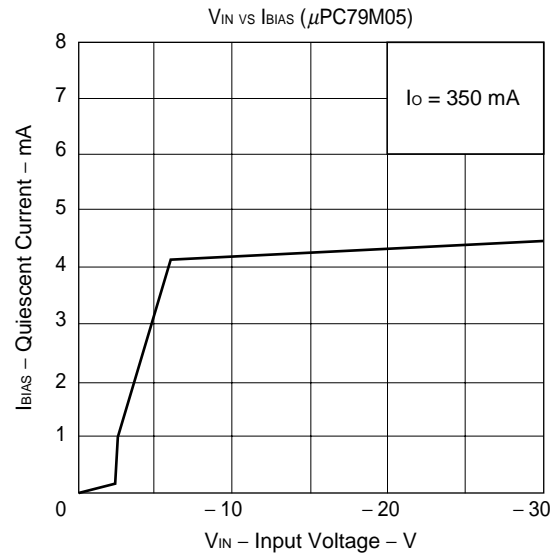
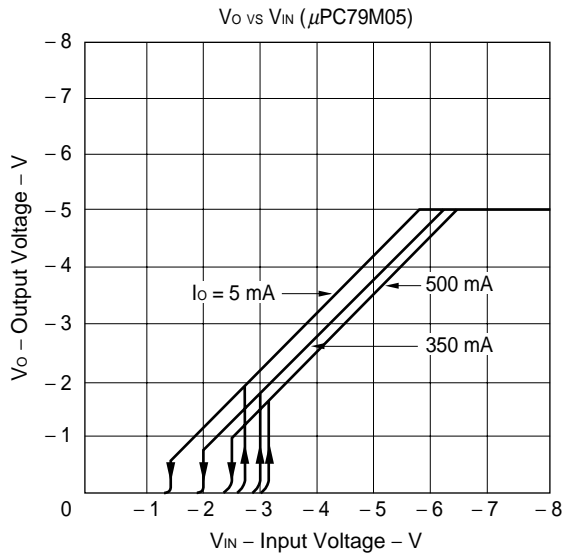
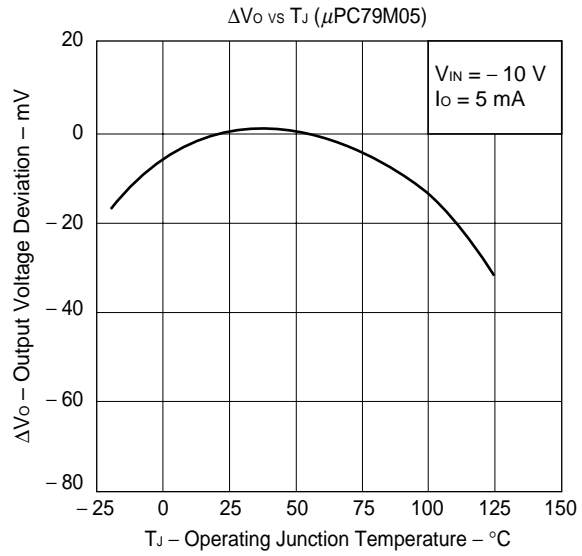
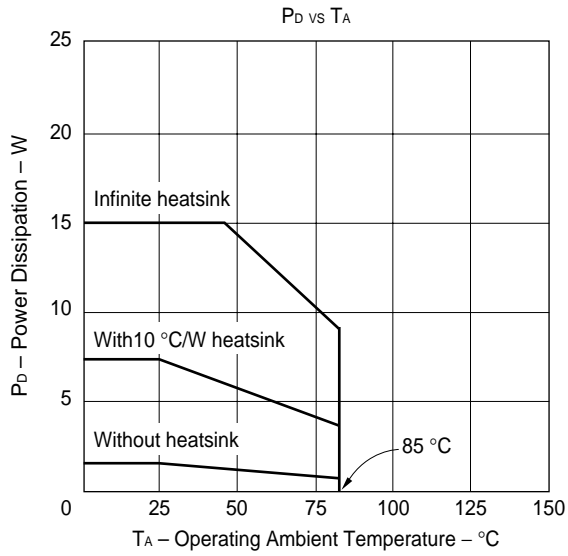

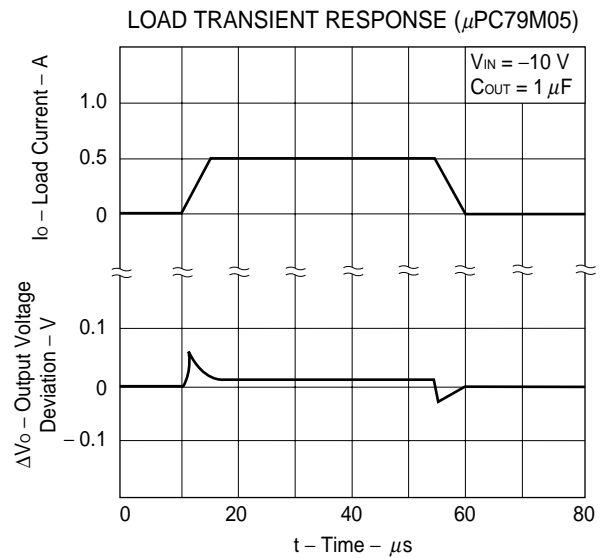
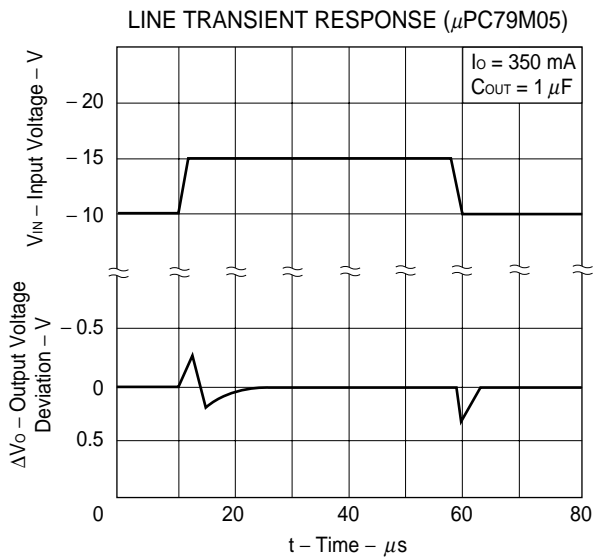
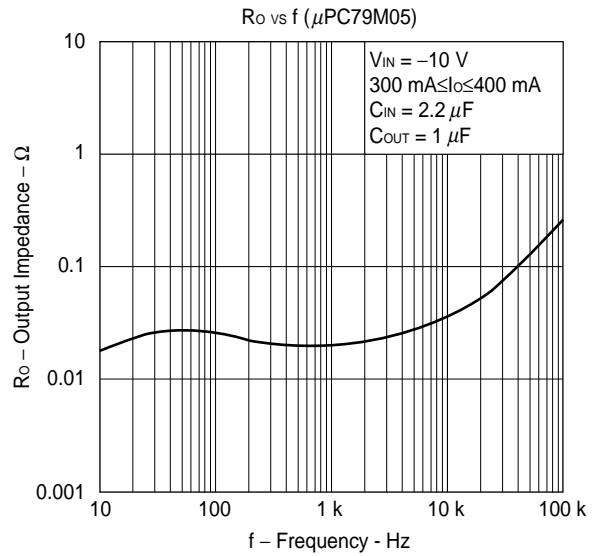
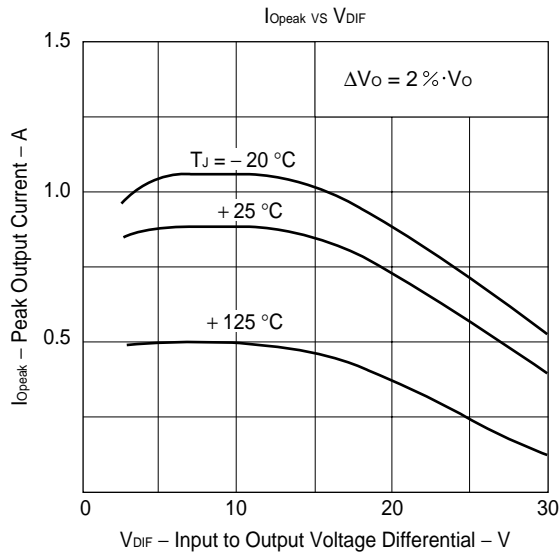

PACKAGE DRAWINGS

3PIN PLASTIC SIP (MP-45G)

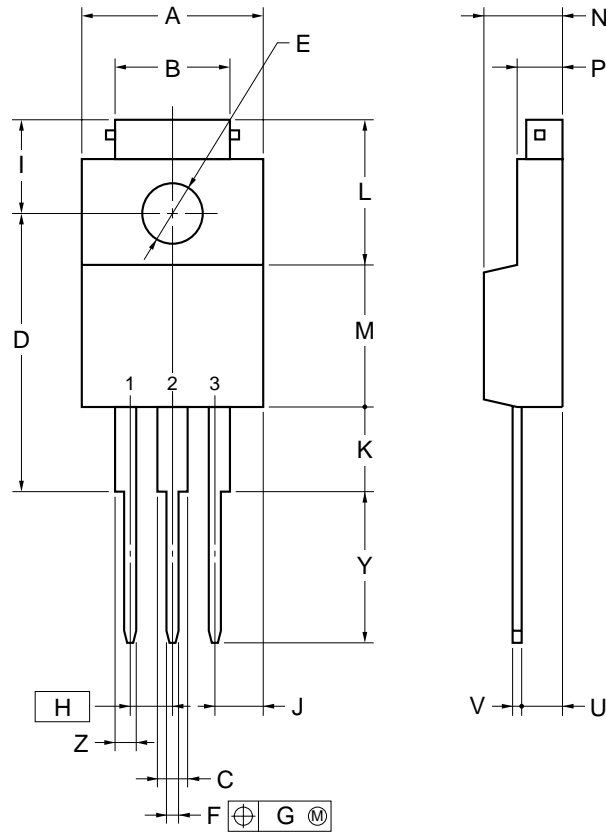

NOTE

Each lead centerline is located within 0.25 mm (0.01 inch) of its true position (T.P.) at maximum material condition.

ITEM	MILLIMETERS	INCHES
A	10.4 MAX.	0.410 MAX.
B	7.0	0.276
C	1.2 MIN.	0.047 MIN.
D	17.0±0.3	0.669 ^{+0.013} _{-0.012}
E	φ3.3±0.2	φ0.130±0.008
F	0.75±0.10	0.030 ^{+0.004} _{-0.005}
G	0.25	0.010
H	2.54 (T.P.)	0.100 (T.P.)
I	5.0±0.3	0.197±0.012
J	2.66 MAX.	0.105 MAX.
K	4.8 MIN.	0.188 MIN.
L	8.5	0.335
M	8.5	0.335
N	4.5±0.2	0.177±0.008
P	2.8±0.2	0.110 ^{+0.009} _{-0.008}
U	2.4±0.5	0.094 ^{+0.021} _{-0.020}
V	0.65±0.10	0.026 ^{+0.004} _{-0.005}
Y	8.9±0.7	0.350±0.028
Z	1.0 MIN.	0.039 MIN.

P3HF-254B-3

RECOMMENDED SOLDERING CONDITIONS

When soldering these products, it is highly recommended to observe the conditions as shown below. If other soldering processes are used, or if the soldering is performed under different conditions, please make sure to consult with our sales offices.

For more details, refer to our document “**SEMICONDUCTOR DEVICE MOUNTING TECHNOLOGY MANUAL**” (C10535E).

Type of Through-hole Devices

μPC79M05HF, 79M08HF, 79M12HF, 79M15HF, 79M18HF, 79M24HF: 3-pin plastic SIP (MP-45G)

Process	Conditions
Wave soldering (only to leads)	Solder temperature: 260 °C or below, Flow time: 10 seconds or less.

Caution For through-hole device, the wave soldering process must be applied only to leads, and make sure that the package body does not get jet soldered.

★ **REFERENCE DOCUMENTS**

Quality Grades on NEC Semiconductor Devices	C11531E
Semiconductor Device Mounting Technology Manual	C10535E
IC Package Manual	C10943X
Guide to Quality Assurance for Semiconductor Devices	MEI-1202
Semiconductors Selection Guide	X10679E
NEC Semiconductor Device Reliability/Quality Control System	IEI-1212
-Three Terminal Regulator	

[MEMO]

[MEMO]

[MEMO]

The application circuits and their parameters are for reference only and are not intended for use in actual design-ins.

No part of this document may be copied or reproduced in any form or by any means without the prior written consent of NEC Corporation. NEC Corporation assumes no responsibility for any errors which may appear in this document.

NEC Corporation does not assume any liability for infringement of patents, copyrights or other intellectual property rights of third parties by or arising from use of a device described herein or any other liability arising from use of such device. No license, either express, implied or otherwise, is granted under any patents, copyrights or other intellectual property rights of NEC Corporation or others.

While NEC Corporation has been making continuous effort to enhance the reliability of its semiconductor devices, the possibility of defects cannot be eliminated entirely. To minimize risks of damage or injury to persons or property arising from a defect in an NEC semiconductor device, customers must incorporate sufficient safety measures in its design, such as redundancy, fire-containment, and anti-failure features.

NEC devices are classified into the following three quality grades:

"Standard", "Special", and "Specific". The Specific quality grade applies only to devices developed based on a customer designated "quality assurance program" for a specific application. The recommended applications of a device depend on its quality grade, as indicated below. Customers must check the quality grade of each device before using it in a particular application.

Standard: Computers, office equipment, communications equipment, test and measurement equipment, audio and visual equipment, home electronic appliances, machine tools, personal electronic equipment and industrial robots

Special: Transportation equipment (automobiles, trains, ships, etc.), traffic control systems, anti-disaster systems, anti-crime systems, safety equipment and medical equipment (not specifically designed for life support)

Specific: Aircrafts, aerospace equipment, submersible repeaters, nuclear reactor control systems, life support systems or medical equipment for life support, etc.

The quality grade of NEC devices is "Standard" unless otherwise specified in NEC's Data Sheets or Data Books. If customers intend to use NEC devices for applications other than those specified for Standard quality grade, they should contact an NEC sales representative in advance.

Anti-radioactive design is not implemented in this product.